

Driver LC 15W 200-350mA flexC T SNC3

essence in-track series (3-phase system)



Black (RAL 9005)



White (RAL 9010)



Grey (RAL 7035)

Product description

- _ Constant current / in-track LED driver
- _ Optional accessory ACU ALU NIPPLE M10x1 for mounting the luminaire head
- _ Compatible 3-phase system in-tracks, see data sheet chapter 3.8
- _ For luminaires of protection class II
- _ BIS approval mark for the white and black versions only
- _ Temperature protection as per EN 61347-2-13 C5e
- _ Selectable fixed output current via DIP switch 350, 300, 250 and 200 mA (pre-selected current 200 mA)
- _ Max. output power 14.7 W
- _ Up to 85 % efficiency
- _ Nominal lifetime up to 100,000 h
- _ 5 years guarantee (Conditions at <https://www.tridonic.com/manufacturer-guarantee-conditions>)

Housing properties

- _ Casing: polycarbonate, black, white or grey
- _ Type of protection IP20

Functions

- _ Overload protection
- _ Short-circuit protection
- _ No-load protection

Typical applications

- _ For spot light in retail and hospitality application

Website

<http://www.tridonic.com/87501149>



Spotlights



Downlights



Linear



Area



Floor | Wall



Free-standing



Street



Decorative



High bay

Specific technical data

Type	Output current ^④	Min. output voltage	Max. output voltage	Max. output power	Typ. power consumption (at 230 V, 50 Hz, full load)	Typ. current consumption (at 230 V, 50 Hz, full load)	tc point max.	Ambient temperature ta	I-out select
LC 15/200-350/42 flexC T-B SNC3	200 mA	24 V	42 V	8.4 W	9.5 W	50 mA	50 °C	-20 ... +35 °C	1=off / 2=off
LC 15/200-350/42 flexC T-B SNC3	250 mA	24 V	42 V	10.5 W	12.0 W	60 mA	50 °C	-20 ... +35 °C	1=off / 2=on
LC 15/200-350/42 flexC T-B SNC3	300 mA	24 V	42 V	12.6 W	14.5 W	70 mA	55 °C	-20 ... +35 °C	1=on / 2=off
LC 15/200-350/42 flexC T-B SNC3	350 mA	24 V	42 V	14.7 W	17.5 W	80 mA	60 °C	-20 ... +35 °C	1=on / 2=on
LC 15/200-350/42 flexC T-W SNC3	200 mA	24 V	42 V	8.4 W	9.5 W	50 mA	50 °C	-20 ... +35 °C	1=off / 2=off
LC 15/200-350/42 flexC T-W SNC3	250 mA	24 V	42 V	10.5 W	12.0 W	60 mA	50 °C	-20 ... +35 °C	1=off / 2=on
LC 15/200-350/42 flexC T-W SNC3	300 mA	24 V	42 V	12.6 W	14.5 W	70 mA	55 °C	-20 ... +35 °C	1=on / 2=off
LC 15/200-350/42 flexC T-W SNC3	350 mA	24 V	42 V	14.7 W	17.5 W	80 mA	60 °C	-20 ... +35 °C	1=on / 2=on
LC 15/200-350/42 flexC T-G SNC3	200 mA	24 V	42 V	8.4 W	9.5 W	50 mA	50 °C	-20 ... +35 °C	1=off / 2=off
LC 15/200-350/42 flexC T-G SNC3	250 mA	24 V	42 V	10.5 W	12.0 W	60 mA	50 °C	-20 ... +35 °C	1=off / 2=on
LC 15/200-350/42 flexC T-G SNC3	300 mA	24 V	42 V	12.6 W	14.5 W	70 mA	55 °C	-20 ... +35 °C	1=on / 2=off
LC 15/200-350/42 flexC T-G SNC3	350 mA	24 V	42 V	14.7 W	17.5 W	80 mA	60 °C	-20 ... +35 °C	1=on / 2=on

① Maximum of "perception and reaction" and "let go" values according to EN 60598-1.

② Test result at 25 °C.

③ Test result at max. current.

④ Output current is mean value.

ACU ALU NIPPLE M10x8

Accessory

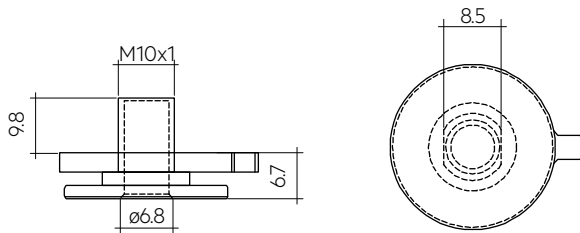
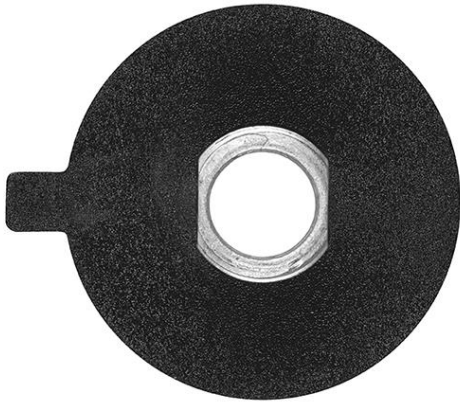
**Product description**

- _ Optional threaded sleeve for luminaire mounting
- _ Suitable for M10x8 mm threaded nut
- _ We suggest to use mechanical way(screw) to assemble the nipple and track light fixture, use glue may have potential risk to change the material characteristics and destroy the plastic gasket and the nipple.

Website

<http://www.tridonic.com/28005589>

**Ordering data**

Type	Article number	Weight per pc.
ACU ALU NIPPLE M10x8 BK	28005589	0.243 kg
ACU ALU NIPPLE M10x8 WH	28005590	0.005 kg
ACU ALU NIPPLE M10x8 GR	28005591	0.005 kg

1. Standards

EN 55015
 EN 61000-3-2
 EN 61000-3-3
 EN 61347-1
 EN 61347-2-13
 EN 61547
 EN 61000-4-4
 EN 61000-4-5

1.1 Glow-wire test

According to EN 61347-1 with increased temperature of 850 °C passed.

2. Thermal details and lifetime

2.1 Expected lifetime

Expected lifetime				
Type	Output current	ta	25 °C	35 °C
LC 15/200-350/42 flexC T SNC3	200 mA	Lifetime	> 100,000 h	> 50,000 h
	250 mA	Lifetime	> 100,000 h	> 50,000 h
	300 mA	Lifetime	> 100,000 h	> 50,000 h
	350 mA	Lifetime	> 100,000 h	> 50,000 h

The LED drivers are designed for a lifetime stated above under reference conditions and with a failure probability of less than 10 %.

Temperatures were measured with Tracktype PRO-310 from manufacturer powergear. Temperatures can deviate with tracks from other manufacturers.

3. Installation / wiring

3.1 Circuit diagram

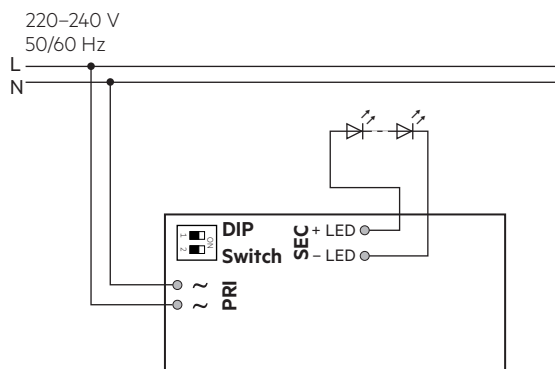

3.2 Wiring type and cross section

For wiring use stranded wire with ferrules or solid wire from 0.5–1.5 mm². Strip 8.5–9.5 mm of insulation from the cables to ensure perfect operation of the push-wire terminals.

Use one wire for each terminal connector only.

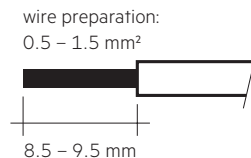

3.3 Release of the wiring

Press down the “push button” and remove the cable from front.

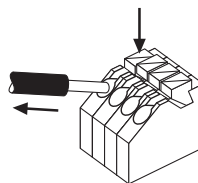

3.4 Fixing conditions

Dry, acidfree, oilfree, fatfree. It is not allowed to exceed the maximum ambient temperature (ta) stated on the device.

3.5 Wiring guidelines

- All connections must be kept as short as possible to ensure good EMI behaviour.
- Max. length of output wires is 20 cm.
- Secondary switching is not permitted.
- Incorrect wiring can damage LED modules.
- To avoid damage of the Driver, the wiring must be protected against short circuits to earth (sharp edged metal parts, metal cable clips, louver, etc.).

3.6 Replace LED module

1. Mains off
2. Remove LED module
3. Wait for 30 seconds
4. Connect LED module again

Hot plug-in or secondary switching of LEDs is not permitted and may cause a very high current to the LEDs.

3.7 Mounting luminaire

Max. allowed weight of complete luminaire: 5 kg (50 N)

3.8 Compatible tracks

Subject to be changed without notice.

Manufacturer	Type	System	Intrack casing colour
EUTRAC	25-XX-XX / 26-XX-XX	3P	Black, white, grey
IVELA	7501 / 7511 / 7512	3P	Black, white, grey
NORDIC ALUMINIUM	GLOBAL Trac Pro XTS 4xxx	3P	Black, white, grey
NORDIC ALUMINIUM	GLOBAL Trac Pro XTSF 4xxx	3P	Black, white, grey
Stucchi	One track	3P	Black, white, grey
Powergear	PRO-04X0	3P	Black, white, grey

Tests have been done with in-tracks taken from the market in the first half of 2020.



Tridonic has no control or responsibility on any future or past possible changes made by different manufactures that could affect the compatibility between tracks and adaptors.

3.9 Adapter mounting into the track

Insert the adapter into the track, so that the mechanical key (A) in the adaptor matches the groove (B) in the track. Rotate of about 90° the lever of the cam (C) until it reaches the locking position.

To open rotate the lever the opposite direction.

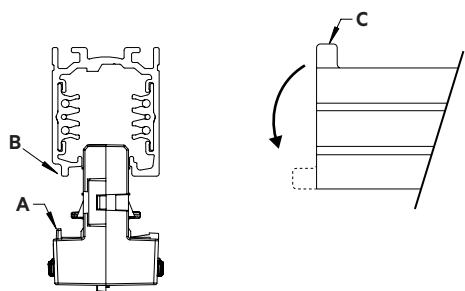

3.10 Phase selection

When the track is connected to a three-phase system it is possible to select the phase (L1, L2 or L3) to distribute the single luminaires in the system, by means of the proper selector of the adaptor.

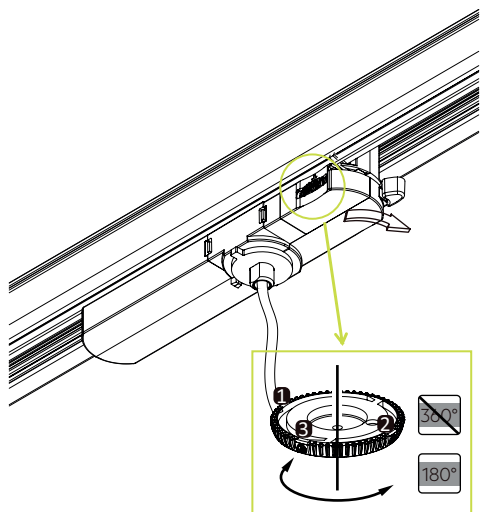

3.11 Current setting



Set the current by DIP switch after mains off. Use of DIP switch only after mains off.

200 mA: Switch 1 = Off, Switch 2 = Off

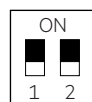

250 mA: Switch 1 = Off, Switch 2 = On

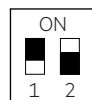

300 mA: Switch 1 = On, Switch 2 = Off

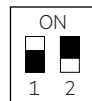

350 mA: Switch 1 = On, Switch 2 = On

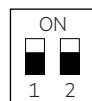

4. Electrical values

4.1 Efficiency vs load

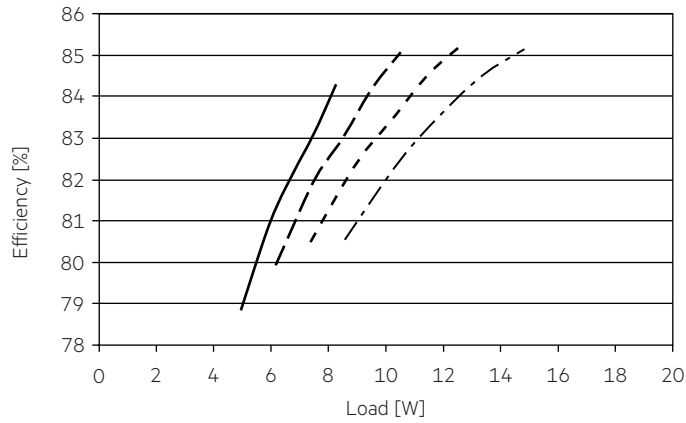

4.2 Power factor vs load

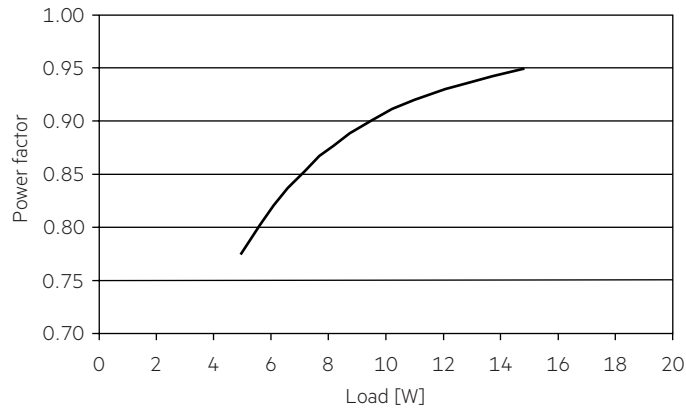

4.3 THD vs load

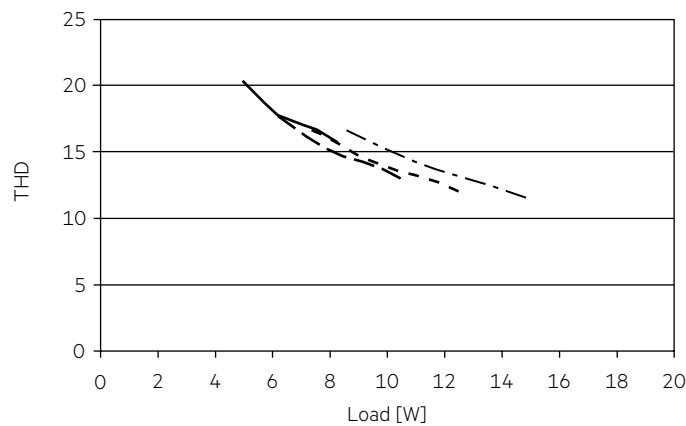

- 200 mA
- - - 250 mA
- - - - 300 mA
- · - · - 350 mA

4.6 Maximum loading of automatic circuit breakers in relation to inrush current

Automatic circuit breaker type	C10	C13	C16	C20	B10	B13	B16	B20	Inrush current	
Installation Ø	1.5 mm ²	1.5 mm ²	2.5 mm ²	2.5 mm ²	1.5 mm ²	1.5 mm ²	2.5 mm ²	2.5 mm ²	I _{max}	Time
LC 15/200-350/42 flexC T SNC3	94	122	151	188	94	122	151	188	6 A	20 µs

These are max. values calculated out of inrush current! Please consider not to exceed the maximum rated continuous current of the circuit breaker. Calculation uses typical values from ABB series S200 as a reference. Actual values may differ due to used circuit breaker types and installation environment.

4.7 Harmonic distortion in the mains supply (at 230 V / 50 Hz and full load) in %

	THD	3.	5.	7.	9.	11.
LC 15/200-350/42 flexC T SNC3	< 15	< 12	< 7	< 6	< 5	< 5

5. Functions

5.1 Short-circuit behaviour

In case of a short circuit on the secondary side (LED) the LED driver switches off. After elimination of the short-circuit fault the LED driver will recover automatically.

5.2 No-load operation

The LED driver works in burst working mode to provide a constant output voltage regulation which allows the application to be able to work safely when LED string opens due to a failure.

5.3 Overload protection

If the maximum load is exceeded by a defined internal limit, the LED driver will protect itself and LED may flicker. After elimination of the overload the nominal operation will recover automatically.

6. Miscellaneous

6.1 Insulation and electric strength testing of luminaires

Electronic devices can be damaged by high voltage. This has to be considered during the routine testing of the luminaires in production.

According to IEC 60598-1 Annex Q (informative only!) or ENEC 303-Annex A, each luminaire should be submitted to an insulation test with 500 V_{DC} for 1 second. This test voltage should be connected between the interconnected phase and neutral terminals and the earth terminal. The insulation resistance must be at least 2 MΩ.

As an alternative, IEC 60598-1 Annex Q describes a test of the electrical strength with 1500 V_{AC} (or 1.414 x 1500 V_{DC}). To avoid damage to the electronic devices this test must not be conducted.

6.2 Conditions of use and storage

Humidity: 5% up to max. 85%,
not condensed
(max. 56 days/year at 85%)

Storage temperature: -40 °C up to max. +80 °C

The devices have to be within the specified temperature range (t_a) before they can be operated.

6.3 Maximum number of switching cycles

All LED driver are tested with 50,000 switching cycles.

6.4 Additional information

Additional technical information at www.tridonic.com → Technical Data

Lifetime declarations are informative and represent no warranty claim. No warranty if device was opened.