

Module LLE 24mm 1250lm CRI90 LV ADV6

Modules LLE advanced

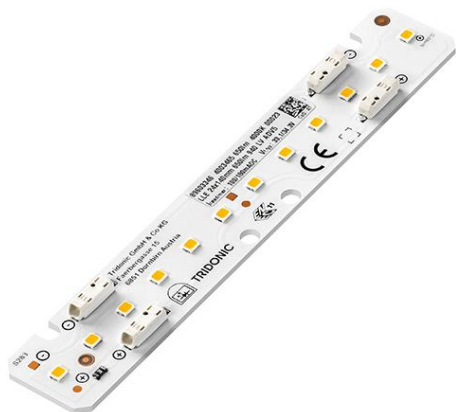

LLE 24x140mm 650lm LV ADV6



LLE 24x280mm 1250lm LV ADV6



LLE 24x560mm 2400lm LV ADV6

Product description

- _ Ideal for linear and panel lights
- _ 4 terminals for parallel wiring
- _ 4,000 K module COI approved acc. to AS/NZS1680.2.5:1997
- _ Perfectly uniform light, even if several LED modules are used together in a line
- _ Push terminals for quick and simple wiring of LED module to LED module
- _ Broad portfolio from extruded lenses and covers available
- _ HE ... High Efficiency, NM ... Nominal Mode, HO ... High Output
- _ Long lifetime up to 72,000 hours
- _ 5 years guarantee (conditions at <https://www.tridonic.com/manufacture-guarantee-conditions>)

Optical properties

- _ Colour temperatures 2,700, 3,000, 3,500 and 4,000 K
- _ Useful luminous flux 2,264 lm at Irated and tp = 25 °C
- _ Efficacy of the LED module 171 lm/W at Irated and tp = 25 °C
- _ High colour rendering index CRI > 90
- _ High colour consistency (MacAdam 3) ^①
- _ Small luminous flux tolerances

Mechanical properties

- _ Module dimension 24 x 140 mm, 24 x 280 mm and 24 x 560 mm (ZHAGA compliant)
- _ Simple installation via clips or screws

System solution

- _ Combine Tridonic's LED modules and dimmable drivers to achieve an outstanding system efficacy (configuration possible via <https://setbuilder.tridonic.com/>)

^① Integral measurement over the complete module.

Website

<http://www.tridonic.com/28004860>

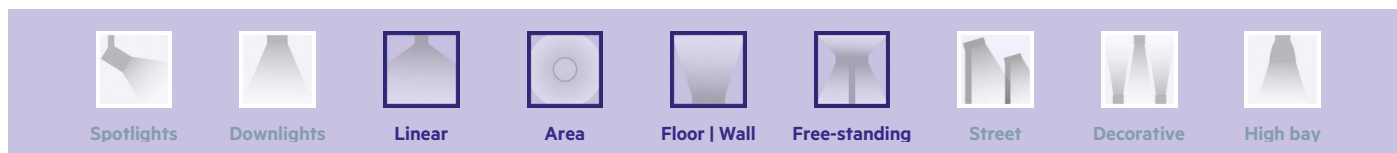
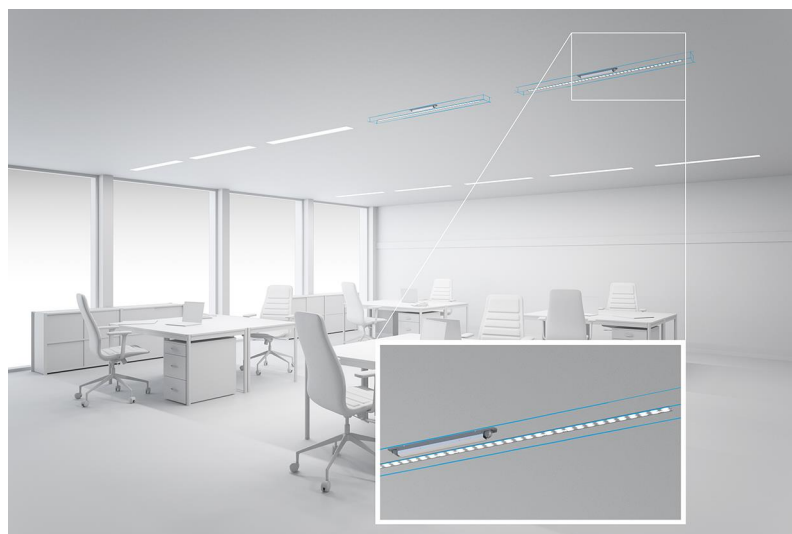

Module LLE 24mm 1250lm CRI90 LV ADV6

Modules LLE advanced

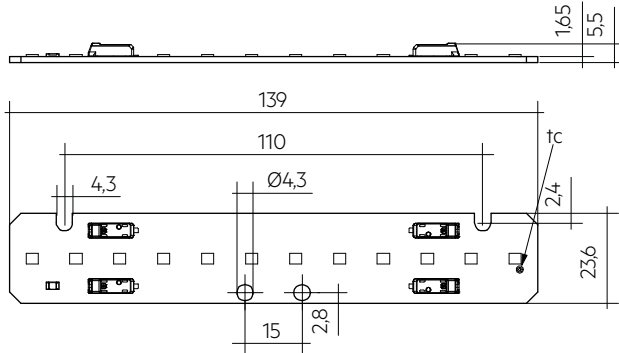

LLE 24x140mm 650lm LV ADV6

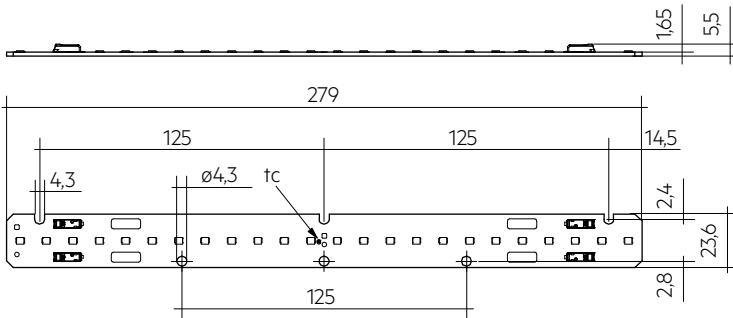

LLE 24x280mm 1250lm LV ADV6

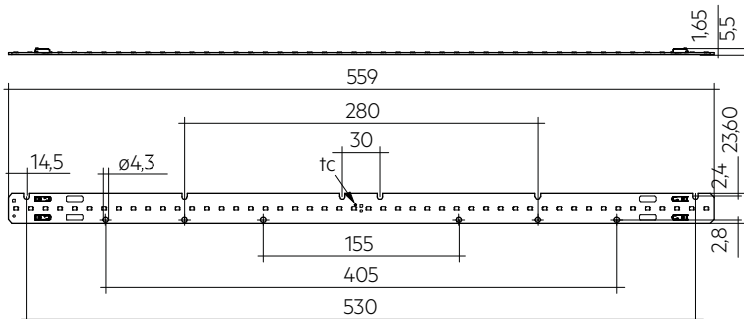

LLE 24x560mm 2400lm LV ADV6

Ordering data

| Type | Article number | Colour temperature | Packaging, carton | Weight per pc. |
|---------------------------------|----------------|--------------------|-------------------|----------------|
| Frontside terminal | | | | |
| LLE 24x140mm 650lm 927 LV ADV6 | 28004860 | 2,700 K | 108 pc(s). | 0.012 kg |
| LLE 24x140mm 650lm 930 LV ADV6 | 28004861 | 3,000 K | 108 pc(s). | 0.012 kg |
| LLE 24x140mm 650lm 935 LV ADV6 | 28004862 | 3,500 K | 108 pc(s). | 0.012 kg |
| LLE 24x140mm 650lm 940 LV ADV6 | 28004863 | 4,000 K | 108 pc(s). | 0.012 kg |
| LLE 24x280mm 1250lm 927 LV ADV6 | 28004870 | 2,700 K | 108 pc(s). | 0.024 kg |
| LLE 24x280mm 1250lm 930 LV ADV6 | 28004871 | 3,000 K | 108 pc(s). | 0.024 kg |
| LLE 24x280mm 1250lm 935 LV ADV6 | 28004872 | 3,500 K | 108 pc(s). | 0.024 kg |
| LLE 24x280mm 1250lm 940 LV ADV6 | 28004873 | 4,000 K | 108 pc(s). | 0.024 kg |
| LLE 24x560mm 2400lm 927 LV ADV6 | 28004880 | 2,700 K | 108 pc(s). | 0.044 kg |
| LLE 24x560mm 2400lm 930 LV ADV6 | 28004881 | 3,000 K | 108 pc(s). | 0.044 kg |
| LLE 24x560mm 2400lm 935 LV ADV6 | 28004882 | 3,500 K | 108 pc(s). | 0.044 kg |
| LLE 24x560mm 2400lm 940 LV ADV6 | 28004883 | 4,000 K | 108 pc(s). | 0.044 kg |

Technical data

| | |
|---|--|
| Beam characteristic | 120° |
| Ambient temperature t_a | -40 ... +65 °C |
| t_p rated | 50 °C |
| t_c | 85 °C |
| I _{rated} for 650 lm | 100 mA |
| I _{rated} for 1,250 lm | 200 mA |
| I _{rated} for 2,400 lm | 400 mA |
| I _{max} for 650 lm | 200 mA |
| I _{max} for 1,250 lm | 400 mA |
| I _{max} for 2,400 lm | 800 mA |
| Max. permissible LF current ripple for 650 lm | 220 mA |
| Max. permissible LF current ripple for 1,250 lm | 440 mA |
| Max. permissible LF current ripple for 2,400 lm | 880 mA |
| Max. permissible peak current for 650 lm | 300 mA / max. 10 ms |
| Max. permissible peak current for 1,250 lm | 600 mA / max. 10 ms |
| Max. permissible peak current for 2,400 lm | 1,200 mA / max. 10 ms |
| Max. working voltage for insulation SELV [®] | 60 V |
| Insulation test voltage | 0.5 kV |
| Colour tolerance | 3 SDCM |
| ESD classification | Severity level 2 |
| Risk group (IEC 62471) for 650 lm | RG1 (> 93 – 200 mA (I _{max})), RGO (≤ 93 mA) |
| Risk group (IEC 62471) for 1,250lm | RG1 (> 186 – 400 mA (I _{max})), RGO (≤ 186 mA) |
| Risk group (IEC 62471) for 2,400 lm | RG1 (> 372 – 800 mA (I _{max})), RGO (≤ 372 mA) |
| Classification acc. to IEC 62031 | Built-in |
| Type of protection | IP00 |
| Lumen maintenance L70B50 | 72,000 h |
| Guarantee (conditions at www.tridonic.com) | 5 Year(s) |

Approval marks**Standards**

IEC 62031, IEC 62471, IEC 61000-4-2, IEC 62778, IEC 61547, UL 8750

Specific technical data

| Type | Article number | Photometric code ^② | Useful luminous flux at tp = 25 °C ^③ | Expected luminous flux at tp rated | Typ. forward current | Min. forward voltage at tp rated | Max. forward voltage at tp = 25 °C | Power consumption Pon at tp = 25 °C ^④ | Efficacy of the module at tp = 25 °C | Expected efficacy of the module at tp rated | Colour rendering index CRI |
|---------------------------------|----------------|-------------------------------|---|------------------------------------|----------------------|----------------------------------|------------------------------------|--|--------------------------------------|---|----------------------------|
| Operating mode HE | | | | | | | | | | | |
| LLE 24x140mm 650lm 927 LV ADV6 | 28004860 | 927/359 | - | 260 lm | 50 mA | 31.8 V | 33.3 V | - | - | 163 lm/W | >90 |
| LLE 24x140mm 650lm 930 LV ADV6 | 28004861 | 930/359 | - | 268 lm | 50 mA | 31.8 V | 33.3 V | - | - | 168 lm/W | >90 |
| LLE 24x140mm 650lm 935 LV ADV6 | 28004862 | 935/359 | - | 275 lm | 50 mA | 31.8 V | 33.3 V | - | - | 172 lm/W | >90 |
| LLE 24x140mm 650lm 940 LV ADV6 | 28004863 | 940/359 | - | 278 lm | 50 mA | 31.8 V | 33.3 V | - | - | 174 lm/W | >90 |
| LLE 24x280mm 1250lm 927 LV ADV6 | 28004870 | 927/359 | - | 520 lm | 100 mA | 31.8 V | 33.3 V | - | - | 163 lm/W | >90 |
| LLE 24x280mm 1250lm 930 LV ADV6 | 28004871 | 930/359 | - | 536 lm | 100 mA | 31.8 V | 33.3 V | - | - | 168 lm/W | >90 |
| LLE 24x280mm 1250lm 935 LV ADV6 | 28004872 | 935/359 | - | 550 lm | 100 mA | 31.8 V | 33.3 V | - | - | 172 lm/W | >90 |
| LLE 24x280mm 1250lm 940 LV ADV6 | 28004873 | 940/359 | - | 557 lm | 100 mA | 31.8 V | 33.3 V | - | - | 174 lm/W | >90 |
| LLE 24x560mm 2400lm 927 LV ADV6 | 28004880 | 927/359 | - | 1,040 lm | 200 mA | 31.8 V | 33.3 V | - | - | 162 lm/W | >90 |
| LLE 24x560mm 2400lm 930 LV ADV6 | 28004881 | 930/359 | - | 1,072 lm | 200 mA | 31.8 V | 33.3 V | - | - | 167 lm/W | >90 |
| LLE 24x560mm 2400lm 935 LV ADV6 | 28004882 | 935/359 | - | 1,100 lm | 200 mA | 31.8 V | 33.3 V | - | - | 172 lm/W | >90 |
| LLE 24x560mm 2400lm 940 LV ADV6 | 28004883 | 940/359 | - | 1,114 lm | 200 mA | 31.8 V | 33.3 V | - | - | 174 lm/W | >90 |
| Operating mode NM | | | | | | | | | | | |
| LLE 24x140mm 650lm 927 LV ADV6 | 28004860 | 927/359 | 528 lm | 507 lm | 100 mA | 32.7 V | 34.2 V | 3.3 W | 159 lm/W | 154 lm/W | >90 |
| LLE 24x140mm 650lm 930 LV ADV6 | 28004861 | 930/359 | 544 lm | 522 lm | 100 mA | 32.7 V | 34.2 V | 3.3 W | 164 lm/W | 159 lm/W | >90 |
| LLE 24x140mm 650lm 935 LV ADV6 | 28004862 | 935/359 | 558 lm | 536 lm | 100 mA | 32.7 V | 34.2 V | 3.3 W | 168 lm/W | 163 lm/W | >90 |
| LLE 24x140mm 650lm 940 LV ADV6 | 28004863 | 940/359 | 566 lm | 543 lm | 100 mA | 32.7 V | 34.2 V | 3.3 W | 171 lm/W | 165 lm/W | >90 |
| LLE 24x280mm 1250lm 927 LV ADV6 | 28004870 | 927/359 | 1,056 lm | 1,014 lm | 200 mA | 32.7 V | 34.2 V | 6.6 W | 159 lm/W | 154 lm/W | >90 |
| LLE 24x280mm 1250lm 930 LV ADV6 | 28004871 | 930/359 | 1,088 lm | 1,045 lm | 200 mA | 32.7 V | 34.2 V | 6.6 W | 164 lm/W | 159 lm/W | >90 |
| LLE 24x280mm 1250lm 935 LV ADV6 | 28004872 | 935/359 | 1,117 lm | 1,072 lm | 200 mA | 32.7 V | 34.2 V | 6.6 W | 168 lm/W | 163 lm/W | >90 |
| LLE 24x280mm 1250lm 940 LV ADV6 | 28004873 | 940/359 | 1,132 lm | 1,086 lm | 200 mA | 32.7 V | 34.2 V | 6.6 W | 171 lm/W | 165 lm/W | >90 |
| LLE 24x560mm 2400lm 927 LV ADV6 | 28004880 | 927/359 | 2,112 lm | 2,027 lm | 400 mA | 32.7 V | 34.2 V | 13.3 W | 159 lm/W | 154 lm/W | >90 |
| LLE 24x560mm 2400lm 930 LV ADV6 | 28004881 | 930/359 | 2,177 lm | 2,090 lm | 400 mA | 32.7 V | 34.2 V | 13.3 W | 164 lm/W | 159 lm/W | >90 |
| LLE 24x560mm 2400lm 935 LV ADV6 | 28004882 | 935/359 | 2,235 lm | 2,145 lm | 400 mA | 32.7 V | 34.2 V | 13.3 W | 168 lm/W | 163 lm/W | >90 |
| LLE 24x560mm 2400lm 940 LV ADV6 | 28004883 | 940/359 | 2,264 lm | 2,173 lm | 400 mA | 32.7 V | 34.2 V | 13.3 W | 170 lm/W | 165 lm/W | >90 |
| Operating mode HO | | | | | | | | | | | |
| LLE 24x140mm 650lm 927 LV ADV6 | 28004860 | 927/359 | - | 857 lm | 175 mA | 33.8 V | 35.3 V | - | - | 144 lm/W | >90 |
| LLE 24x140mm 650lm 930 LV ADV6 | 28004861 | 930/359 | - | 883 lm | 175 mA | 33.8 V | 35.3 V | - | - | 148 lm/W | >90 |
| LLE 24x140mm 650lm 935 LV ADV6 | 28004862 | 935/359 | - | 906 lm | 175 mA | 33.8 V | 35.3 V | - | - | 152 lm/W | >90 |
| LLE 24x140mm 650lm 940 LV ADV6 | 28004863 | 940/359 | - | 918 lm | 175 mA | 33.8 V | 35.3 V | - | - | 154 lm/W | >90 |
| LLE 24x280mm 1250lm 927 LV ADV6 | 28004870 | 927/359 | - | 1,713 lm | 350 mA | 33.8 V | 35.3 V | - | - | 144 lm/W | >90 |
| LLE 24x280mm 1250lm 930 LV ADV6 | 28004871 | 930/359 | - | 1,766 lm | 350 mA | 33.8 V | 35.3 V | - | - | 148 lm/W | >90 |
| LLE 24x280mm 1250lm 935 LV ADV6 | 28004872 | 935/359 | - | 1,813 lm | 350 mA | 33.8 V | 35.3 V | - | - | 152 lm/W | >90 |
| LLE 24x280mm 1250lm 940 LV ADV6 | 28004873 | 940/359 | - | 1,836 lm | 350 mA | 33.8 V | 35.3 V | - | - | 154 lm/W | >90 |
| LLE 24x560mm 2400lm 927 LV ADV6 | 28004880 | 927/359 | - | 3,426 lm | 700 mA | 33.8 V | 35.3 V | - | - | 144 lm/W | >90 |
| LLE 24x560mm 2400lm 930 LV ADV6 | 28004881 | 930/359 | - | 3,532 lm | 700 mA | 33.8 V | 35.3 V | - | - | 148 lm/W | >90 |
| LLE 24x560mm 2400lm 935 LV ADV6 | 28004882 | 935/359 | - | 3,625 lm | 700 mA | 33.8 V | 35.3 V | - | - | 152 lm/W | >90 |
| LLE 24x560mm 2400lm 940 LV ADV6 | 28004883 | 940/359 | - | 3,672 lm | 700 mA | 33.8 V | 35.3 V | - | - | 154 lm/W | >90 |

② If mounted with M4 screws with 7 mm head diameter.

③ The detailed explanation, see data sheet section 1.1.

④ Tolerance of useful light flux - 0 % / + 15 %. Measurement uncertainty ± 10 %.

⑤ Measurement uncertainty ± 10 %. Based on calculation.

⑥ Tolerance of power consumption Pon ± 10 %. Measurement uncertainty ± 5 %.

LINEAR COVER LLE

Accessory

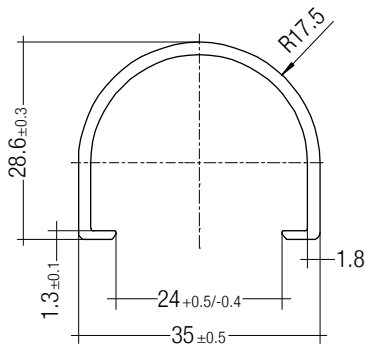

Product description

- _ LINEAR COVER for LLE
- _ Protection against direct touch for non-SELV applications (recommendation LLE 20: use all fixing points and screwed Endcap, recommendation LLE 24: use all fixing points)
- _ Fast snap on mounting on to LLE 20: with M4 screws and plastic washers, to LLE 24: with clips or plastic washers
- _ High transmission: transparent, semi-transparent and diffuse
- _ Material: PMMA
- _ Tolerances: ± 1 mm for 597 mm length (ends finished), + 10 mm from length 1,150 mm (ends raw)

Website

<http://www.tridonic.com/28000338>



Ordering data

| Type | Article number | Colour | Length L | Efficiency | Packaging, carton | Weight per pc. |
|------------------------------------|----------------|------------------|----------|------------|-------------------|----------------|
| LINEAR COVER SY Transparent 1600mm | 28000338 | Transparent | 1,600 mm | 94 % | 12 pc(s). | 0.272 kg |
| LINEAR COVER SY Frosted 1800mm | 28000437 | Semi-transparent | 1,800 mm | 87 % | 12 pc(s). | 0.308 kg |
| LINEAR COVER SY Frosted 1600mm | 28000339 | Semi-transparent | 1,600 mm | 87 % | 12 pc(s). | 0.272 kg |
| LINEAR COVER SY Frosted 1500mm | 28000435 | Semi-transparent | 1,500 mm | 87 % | 12 pc(s). | 0.244 kg |
| LINEAR COVER SY Frosted 1200mm | 28000422 | Semi-transparent | 1,200 mm | 87 % | 12 pc(s). | 0.205 kg |
| LINEAR COVER SY Frosted 597mm | 28000340 | Semi-transparent | 597 mm | 87 % | 12 pc(s). | 0.102 kg |
| LINEAR COVER SY Diffuse 1800mm | 28000438 | Diffuse | 1,800 mm | 76 % | 12 pc(s). | 0.308 kg |
| LINEAR COVER SY Diffuse 1600mm | 28000341 | Diffuse | 1,600 mm | 76 % | 12 pc(s). | 0.272 kg |
| LINEAR COVER SY Diffuse 1500mm | 28000436 | Diffuse | 1,500 mm | 76 % | 12 pc(s). | 0.257 kg |
| LINEAR COVER SY Diffuse 1200mm | 28000434 | Diffuse | 1,200 mm | 76 % | 12 pc(s). | 0.205 kg |
| LINEAR COVER SY Diffuse 597mm | 28000342 | Diffuse | 597 mm | 76 % | 12 pc(s). | 0.102 kg |

ACL ENDCAP LLE

Accessory

**Product description**

- _ ENDCAP for LLE
- _ PUSH-FIX: Fast snap on mounting (sheet thickness 0.5 – 1.0 mm), for drilling hole 4 mm
- _ SCREW-FIX: Screw mounting with EJOT Delta PT WN 5451 30x8 (not included), tightening torque 0.7 Nm
- _ Clip made of polycarbonate

Website

<http://www.tridonic.com/28001037>

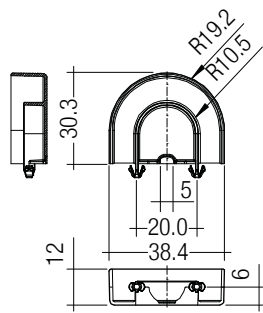
**Ordering data**

| Type | Article number | Colour | Packaging, carton | Weight per pc. |
|----------------------------|----------------|--------|-------------------|----------------|
| ACL ENDCAP LLE24 PUSH-FIX | 28001037 | White | 480 pc(s). | 0.003 kg |
| ACL ENDCAP LLE24 SCREW-FIX | 28002315 | White | 480 pc(s). | 0.003 kg |

ACL LINEAR LENS 24mm

Accessory

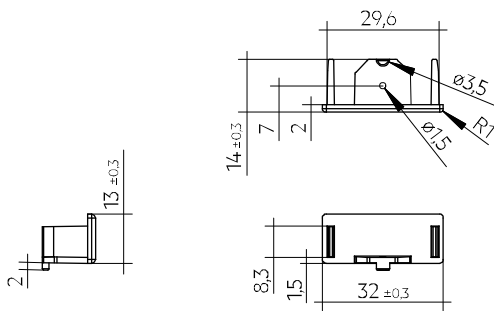
**Product description LINEAR LENS**

- _ Linear lens for LLE 20 / 24
- _ Available with different beam characteristics
- _ Protection against direct touch for non-SELV applications (recommendation: use all fixing points)
- _ Fast snap on mounting on to LLE 20: with M4 screws and plastic washers, to LLE 24: with clips or plastic washers
- _ Recommendation: Fastening with screws and plastic washers, see 2.3 Heat sink specifications in data sheet
- _ Material: PMMA
- _ Available lengths: 1,200, 1,500 and 1,800 mm, Tolerance: + 10 mm (ends raw)
- _ Max. permissible temperature 80 °C
- _ Photometric data available on website

Product description Endcap

- _ ENDCAP for LINEAR LENS 24mm INTENSE, ASY and DASY
- _ Mounting by clipping in and screwing from below using screw EJOT Delta PT WN 5451 20x4, tightening torque 0.7 Nm
- _ Made of Polyamide UL94 V0

Website

<http://www.tridonic.com/28001428>

**Ordering data**

| Type | Article number | Length L | Beam characteristic | Efficiency | Packaging, carton | Weight per pc. |
|-----------------------------------|----------------|----------|---------------------|------------|-------------------|----------------|
| ACL LINEAR LENS 24x1200mm 60° | 28001428 | 1,200 mm | 60° | 97 % | 21 pc(s). | 0.196 kg |
| ACL LINEAR LENS 24x1200mm 90° | 28001429 | 1,200 mm | 90° | 97 % | 21 pc(s). | 0.165 kg |
| ACL LINEAR LENS 24x1500mm 60° | 28000953 | 1,500 mm | 60° | 97 % | 21 pc(s). | 0.261 kg |
| ACL LINEAR LENS 24x1500mm 90° | 28000955 | 1,500 mm | 90° | 97 % | 21 pc(s). | 0.221 kg |
| ACL LINEAR LENS 24x1200mm INTENSE | 28002024 | 1,200 mm | 40° | 95 % | 18 pc(s). | 0.261 kg |
| ACL LINEAR LENS 24x1500mm INTENSE | 28002025 | 1,500 mm | 40° | 95 % | 18 pc(s). | 0.326 kg |
| ACL LINEAR LENS 24x1800mm INTENSE | 28002026 | 1,800 mm | 40° | 95 % | 18 pc(s). | 0.392 kg |
| ACL LINEAR LENS 24x1200mm BATWING | 28002027 | 1,200 mm | batwing | 95 % | 18 pc(s). | 0.275 kg |
| ACL LINEAR LENS 24x1500mm BATWING | 28002028 | 1,500 mm | batwing | 95 % | 18 pc(s). | 0.344 kg |
| ACL LINEAR LENS 24x1800mm BATWING | 28002029 | 1,800 mm | batwing | 95 % | 18 pc(s). | 0.412 kg |
| ACL LINEAR LENS 24x1200mm ASY | 28002030 | 1,200 mm | asymmetric | 95 % | 18 pc(s). | 0.250 kg |
| ACL LINEAR LENS 24x1500mm ASY | 28002031 | 1,500 mm | asymmetric | 95 % | 18 pc(s). | 0.312 kg |
| ACL LINEAR LENS 24x1800mm ASY | 28002032 | 1,800 mm | asymmetric | 95 % | 18 pc(s). | 0.375 kg |
| ACL LINEAR LENS 24x1200mm DASY | 28002033 | 1,200 mm | double asymmetric | 92 % | 18 pc(s). | 0.249 kg |
| ACL LINEAR LENS 24x1500mm DASY | 28002034 | 1,500 mm | double asymmetric | 92 % | 18 pc(s). | 0.311 kg |
| ACL LINEAR LENS 24x1800mm DASY | 28002035 | 1,800 mm | double asymmetric | 92 % | 18 pc(s). | 0.373 kg |
| ACL Endcap LENS 24mm PSF | 28002669 | - | - | - | 3,600 pc(s). | 0.003 kg |

ACL CLIP 4.3mm

Accessory



Product description

- _ Clip for fixation of LED modules with 4.3 mm holes
- _ Fast snap on mounting (sheet thickness 0.5 – 1.0 mm for PUSH-FIX and 1 – 2 mm for PUSH-FIX Long)
- _ For drilling hole 4 mm
- _ Clip made of polycarbonate
- _ Minimum sales quantity 500 pcs.

Website

<http://www.tridonic.com/28001036>



Ordering data

| Type | Article number | Colour | Packaging, bag ^① | Weight per pc. |
|------------------------------|----------------|-------------|-----------------------------|----------------|
| ACL CLIP 4.3mm PUSH-FIX | 28001036 | White | 500 pc(s). | 0.001 kg |
| ACL CLIP 4,3mm PUSH-FIX Long | 28002314 | Transparent | 500 pc(s). | 0.001 kg |

① Minimum sales quantity 500 pcs.

ACL BRIDGE LLE24/40

Accessory

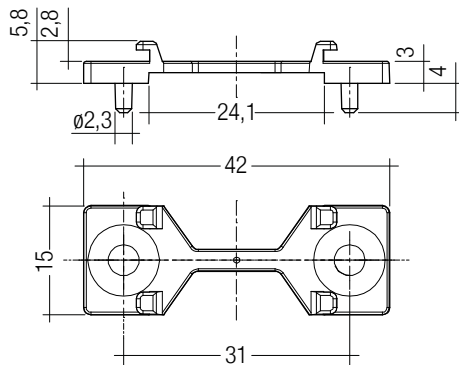
**Product description**

- _ Enables the fixation of 24 mm wide Tridonic LED modules to fixtures made for 40 mm wide modules
- _ Ideal for extruded aluminium gear trays made for 40 mm modules with pre-alignment knobs
- _ Clip-on for LINEAR COVER and LINEAR LENS ^①
- _ For LLE 24 with 280 mm module minimum 2 bridges required
- _ For LLE 24 with 560 mm module minimum 3 bridges required
- _ Fixation via M3 or M4 countersunk screw, max. tightening torque 0.5 Nm
- _ Material: white polycarbonate
- _ Minimum sales quantity 600 pcs.

^① Beam characteristics will change due to the elevated fixation (see photometric files for details).

Website

<http://www.tridonic.com/28001205>

**Ordering data**

| Type | Article number | Colour | Packaging, carton | Weight per pc. |
|-------------------------------|----------------|--------|-------------------|----------------|
| ACL BRIDGE LLE24/40 SCREW-FIX | 28001205 | White | 600 pc(s). | 0.001 kg |

1. Standards

IEC 62031
 IEC 62471
 IEC 61000-4-2
 IEC 62778
 IEC 61547
 UL 8750 (for CLASS2 circuits and dry locations)

1.1 Photometric code

Key for photometric code, e. g. 830 / 349

| 1 st digit | 2 nd + 3 rd digit | 4 th digit | 5 th digit | 6 th digit | | |
|-----------------------|---|-----------------------|---|---|---------------|--------|
| Code | Colour temperature in Kelvin x 100 | MacAdam initial | MacAdam after 25% of the lifetime (max.6000h) | Luminous flux after 25% of the lifetime (max.6000h) | | |
| CRI | | | | Code | Luminous flux | |
| 7 | | | | 70 – 79 | 7 | ≥ 70 % |
| 8 | | | | 80 – 89 | 8 | ≥ 80 % |
| 9 | ≥90 | 9 | ≥ 90 % | | | |

1.2 Risk group

LLE 24x140mm 650lm LV ADV6

| Forward current | Risk group (IEC 62471) |
|----------------------|------------------------|
| ≤ 93 mA | RG0 |
| > 93 – 200 mA (Imax) | RG1 |

LLE 24x280mm 1250lm LV ADV6

| Forward current | Risk group (IEC 62471) |
|-----------------------|------------------------|
| ≤ 186 mA | RG0 |
| > 186 – 400 mA (Imax) | RG1 |

LLE 24x560mm 2400lm LV ADV6

| Forward current | Risk group (IEC 62471) |
|-----------------------|------------------------|
| ≤ 372 mA | RG0 |
| > 372 – 800 mA (Imax) | RG1 |

1.3 Energy classification

| Type | Colour temperature | Forward current | Energy classification | Energy consumption |
|---------------------------------|--------------------|-----------------|-----------------------|--------------------|
| LLE 24x140mm 650lm 927 LV ADV6 | 2,700 K | 100 mA | D | 4 kWh / 1,000 h |
| LLE 24x140mm 650lm 930 LV ADV6 | 3,000 K | 100 mA | D | 4 kWh / 1,000 h |
| LLE 24x140mm 650lm 935 LV ADV6 | 3,500 K | 100 mA | D | 4 kWh / 1,000 h |
| LLE 24x140mm 650lm 940 LV ADV6 | 4,000 K | 100 mA | D | 4 kWh / 1,000 h |
| LLE 24x280mm 1250lm 927 LV ADV6 | 2,700 K | 200 mA | D | 7 kWh / 1,000 h |
| LLE 24x280mm 1250lm 930 LV ADV6 | 3,000 K | 200 mA | D | 7 kWh / 1,000 h |
| LLE 24x280mm 1250lm 935 LV ADV6 | 3,500 K | 200 mA | D | 7 kWh / 1,000 h |
| LLE 24x280mm 1250lm 940 LV ADV6 | 4,000 K | 200 mA | D | 7 kWh / 1,000 h |
| LLE 24x560mm 2400lm 927 LV ADV6 | 2,700 K | 400 mA | D | 14 kWh / 1,000 h |
| LLE 24x560mm 2400lm 930 LV ADV6 | 3,000 K | 400 mA | D | 14 kWh / 1,000 h |
| LLE 24x560mm 2400lm 935 LV ADV6 | 3,500 K | 400 mA | D | 14 kWh / 1,000 h |
| LLE 24x560mm 2400lm 940 LV ADV6 | 4,000 K | 400 mA | D | 14 kWh / 1,000 h |

Energy label and further information at www.tridonic.com in the certificates tab of the corresponding product page and at the EPREL data base <https://eprel.ec.europa.eu/>

2. Thermal details

2.1 tc point, ambient temperature and lifetime

The temperature at tp reference point is crucial for the light output and lifetime of a LED product.

For LLE a tp temperature of 50 °C has to be complied in order to achieve an optimum between heat sink requirements, light output and lifetime.

Compliance with the maximum permissible reference temperature at the tc point must be checked under operating conditions in a thermally stable state. The maximum value must be determined under worst-case conditions for the relevant application.

The tc and tp temperature of LED modules from Tridonic are measured at the same reference point.

2.2 Storage and humidity

| | |
|---------------------|---------------|
| Storage temperature | -40... +80 °C |
|---------------------|---------------|

Operation only in non condensing environment.

Humidity during processing of the module should be between 30 to 70 %.

2.3 Heat sink values

LLE 24x140mm 650lm LV ADV6

| ta | tp | Forward current | R _{th, hs-a} | Cooling area |
|-------|-------|-----------------|-----------------------|----------------------|
| 25 °C | 50 °C | 100 mA | 16.61 K/W | 40 cm ² |
| 25 °C | 50 °C | 175 mA | 7.51 K/W | 89 cm ² |
| 35 °C | 50 °C | 100 mA | 9.39 K/W | 71 cm ² |
| 35 °C | 50 °C | 175 mA | 3.94 K/W | 169 cm ² |
| 40 °C | 50 °C | 100 mA | 5.79 K/W | 115 cm ² |
| 40 °C | 50 °C | 175 mA | 2.15 K/W | 310 cm ² |
| 45 °C | 50 °C | 100 mA | 2.18 K/W | 306 cm ² |
| 45 °C | 50 °C | 175 mA | 0.36 K/W | 1854 cm ² |

LLE 24x280mm 1250lm LV ADV6

| ta | tp | Forward current | R _{th, hs-a} | Cooling area |
|-------|-------|-----------------|-----------------------|-----------------------|
| 25 °C | 50 °C | 200 mA | 8.30 K/W | 80 cm ² |
| 25 °C | 50 °C | 350 mA | 3.76 K/W | 177 cm ² |
| 35 °C | 50 °C | 200 mA | 4.70 K/W | 142 cm ² |
| 35 °C | 50 °C | 350 mA | 1.97 K/W | 339 cm ² |
| 40 °C | 50 °C | 200 mA | 2.89 K/W | 230 cm ² |
| 40 °C | 50 °C | 350 mA | 1.07 K/W | 621 cm ² |
| 45 °C | 50 °C | 200 mA | 1.09 K/W | 612 cm ² |
| 45 °C | 50 °C | 350 mA | 0.18 K/W | 3,708 cm ² |

LLE 24x560mm 2400lm LV ADV6

| ta | tp | Forward current | R _{th, hs-a} | Cooling area |
|-------|-------|-----------------|-----------------------|-----------------------|
| 25 °C | 50 °C | 400 mA | 4.15 K/W | 161 cm ² |
| 25 °C | 50 °C | 700 mA | 1.88 K/W | 355 cm ² |
| 35 °C | 50 °C | 400 mA | 2.35 K/W | 284 cm ² |
| 35 °C | 50 °C | 700 mA | 0.98 K/W | 678 cm ² |
| 40 °C | 50 °C | 400 mA | 1.45 K/W | 461 cm ² |
| 40 °C | 50 °C | 700 mA | 0.54 K/W | 1,242 cm ² |
| 45 °C | 50 °C | 400 mA | 0.54 K/W | 1,224 cm ² |
| 45 °C | 50 °C | 700 mA | 0.09 K/W | 7,415 cm ² |

Notes

The actual cooling surface can differ because of the material, the structural shape, outside influences and the installation situation. Depending on the heat sink a heat conducting paste or heat conducting film might be necessary to keep the specified tp temperature.

For applications with a small distance between LED module and lens, screw mounting is recommended to ensure a reliable thermal connection between LED module and cooling surface.

3. Installation / wiring

3.1 Electrical supply/choice of LED driver

LLE modules from Tridonic are not protected against overvoltages, overcurrents, overloads or short-circuit currents. Safe and reliable operation can only be guaranteed in conjunction with a LED driver which complies with the relevant standards. The use of LED driver from Tridonic in combination with LLE modules guarantees the necessary protection for safe and reliable operation.

If a LED driver other than Tridonic is used, it must provide the following protection:

- Short-circuit protection
- Overload protection
- Overtemperature protection



LLE modules must be supplied by a constant current LED driver. Operation with a constant voltage LED driver will lead to an irreversible damage of the module.

Wrong polarity can damage the LLE.

With parallel wiring tolerance-related differences in output are possible (thermal stress of the module) and can cause differences in brightness. For best homogeneity, only connect modules from one batch in parallel.

If a wire breaks or a complete module fails then the current passing through the other module increases. This may reduce its life considerably.

The max. permissible output current of the LED driver for parallel wiring is 2.8 A.

With parallel connection and a supply on one side, the I_{rated} current must not be exceeded.

With parallel connection and supply on both sides, the forward current for the high output operating mode must not be exceeded.

LLE have to be operated with SELV LED drivers.



LLE are basic insulated up to 60 V SELV (if mounted with M4 screws with head diameter 7 mm in combination with plastic washers) against ground and can be mounted directly on earthed metal parts of the luminaire. If the max. output voltage of the LED driver (also against earth) is above 60 V SELV, an additional insulation between LED module and heat sink is required (for example by insulated thermal pads) or by a suitable luminaire construction.

3.2 Wiring

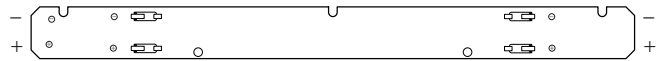

Wiring examples

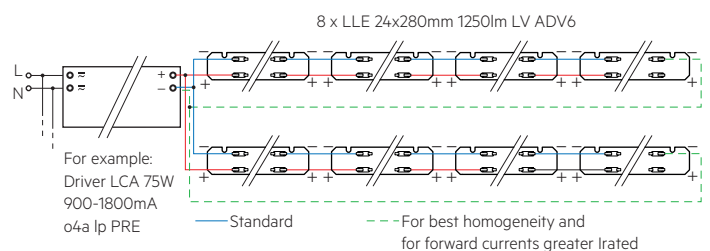
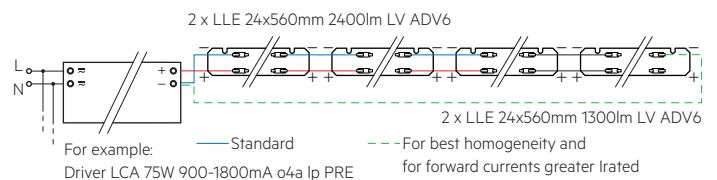
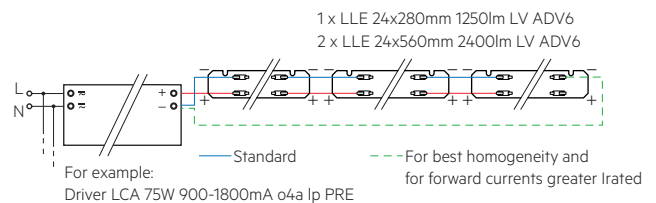
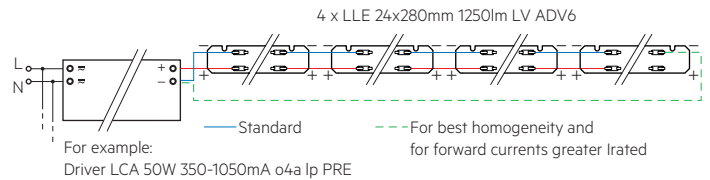

3.3 Wiring type and cross section

For wiring use stranded wire with ferrules or solid wire from 0.2 to 0.75 mm². For the push-wire connection you have to strip the insulation (8–9 mm).

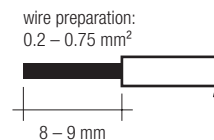

To remove the wires use a suitable tool (e.g. Microcon release pin) or through twist and pull.

3.4 Mounting instruction



None of the components of the LLE (substrate, LED, electronic components etc.) may be exposed to tensile or compressive stresses.

Max. torque for fixing: 0.5 Nm.

The LED modules are mounted onto a heat sink with min. 3 screws per module or ACL CLIP 4.3mm.

Only touch the module at the edge to separate the modules (see marking below).

Cut out on gear tray for backside terminal:

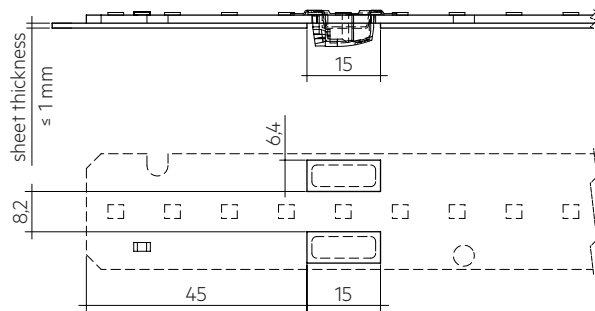

Chemical substance may harm the LED module. Chemical reactions could lead to colour shift, reduced luminous flux or a total failure of the module caused by corrosion of electrical connections.

Materials which are used in LED applications (e.g. sealings, adhesives) must not produce dissolver gas. They must not be condensation curing based, acetate curing based or contain sulfur, chlorine or phthalate.

Avoid corrosive atmosphere during usage and storage.

3.5 EOS/ESD safety guidelines



The device / module contains components that are sensitive to electrostatic discharge and may only be installed in the factory and on site if appropriate EOS/ESD protection measures have been taken. No special measures need be taken for devices/modules with enclosed casings (contact with the pc board not possible), just normal installation practice. Please note the requirements set out in the document EOS / ESD guidelines (Guideline_EOS_ESD.pdf) at: <http://www.tridonic.com/esd-protection>

4. Lifetime

4.1 Lifetime, lumen maintenance and failure rate

The light output of an LED module decreases over the lifetime, this is characterized with the L value.

L70 means that the LED module will give 70 % of its initial luminous flux.

This value is always related to the number of operation hours and therefore defines the lifetime of an LED module.

As the L value is a statistical value and the lumen maintenance may vary over the delivered LED modules.

The B value defines the amount of modules which are below the specific L value, e.g. L70B10 means 10 % of the LED modules are below 70 % of the initial luminous flux, respectively 90 % will be above 70 % of the initial value.

In addition the percentage of failed modules (fatal failure) is characterized by the C value.

4.2 Lumen maintenance for LLE 24mm LV ADV6

| Forward current | tp tempera- ture | L90 / B10 | L90 / B50 | L80 / B10 | L80 / B50 | L70 / B10 | L70 / B50 |
|---|------------------------|-----------|-----------|-----------|-----------|-----------|-----------|
| | | >72k h | >72k h | >72k h | >72k h | >72k h | >72k h |
| 100 mA / ft (280 mm module length) | 40 °C | >72k h | >72k h | >72k h | >72k h | >72k h | >72k h |
| | 50 °C | >72k h | >72k h | >72k h | >72k h | >72k h | >72k h |
| | 60 °C | >72k h | >72k h | >72k h | >72k h | >72k h | >72k h |
| | 70 °C | >72k h | >72k h | >72k h | >72k h | >72k h | >72k h |
| | 80 °C | >72k h | >72k h | >72k h | >72k h | >72k h | >72k h |
| 200 mA / ft (280 mm module length) | 85 °C | >72k h | >72k h | >72k h | >72k h | >72k h | >72k h |
| | 40 °C | 61k h | >72k h | >72k h | >72k h | >72k h | >72k h |
| | 50 °C | 53k h | 71k h | >72k h | >72k h | >72k h | >72k h |
| | 60 °C | 39k h | 51k h | >72k h | >72k h | >72k h | >72k h |
| | 70 °C | 37k h | 48k h | >72k h | >72k h | >72k h | >72k h |
| 350 mA / ft (280 mm module length) | 80 °C | 35k h | 45k h | >72k h | >72k h | >72k h | >72k h |
| | 85 °C | 34k h | 44k h | 70k h | >72k h | >72k h | >72k h |
| | 40 °C | 56k h | >72k h | >72k h | >72k h | >72k h | >72k h |
| | 50 °C | 49k h | 65k h | >72k h | >72k h | >72k h | >72k h |
| | 60 °C | 42k h | 57k h | >72k h | >72k h | >72k h | >72k h |
| 350 mA / ft (280 mm module length) | 70 °C | 37k h | 50k h | >72k h | >72k h | >72k h | >72k h |
| | 80 °C | 32k h | 44k h | 66k h | >72k h | >72k h | >72k h |
| | 85 °C | 30k h | 41k h | 62k h | >72k h | >72k h | >72k h |

L0C10 >72k h. At tp rated, based on 10 swichting cycles per day.

4.3 Switching capability

100,000 cycles

Tridonic test according to IEC 62717 Cl 10.3.3

30 s on / 30 s off at I_{max}

5. Electrical values

5.1 Declaration of electrical parameters

Irated ... Nominal operating current the module is designed for.

I_{max} ... Max. permissible continuous operating current incl. The tolerances of the LED driver.

Max. permissible LF current ripple ... Max. output current of the LED driver incl. Tolerances and LF current ripple must not exceed this value.

Max. permissible peak current ... The max. output peak current of the LED driver must not exceed this value.

5.2 Typ. forward voltage vs. forward current

LLE 24x140mm 650lm 9xx LV ADV6

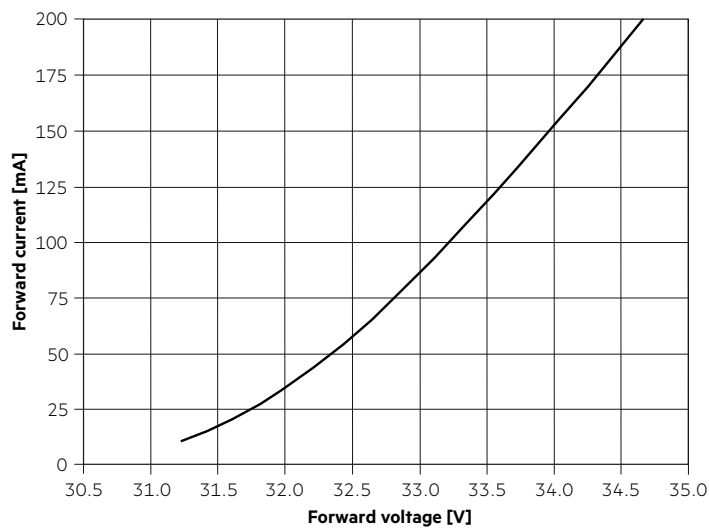

LLE 24x280mm 1250lm 9xx LV ADV6

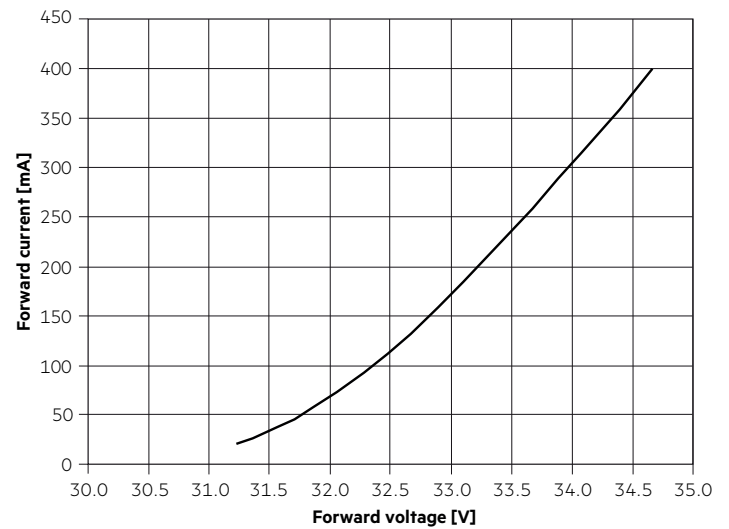

LLE 24x560mm 2400lm 9xx LV ADV6

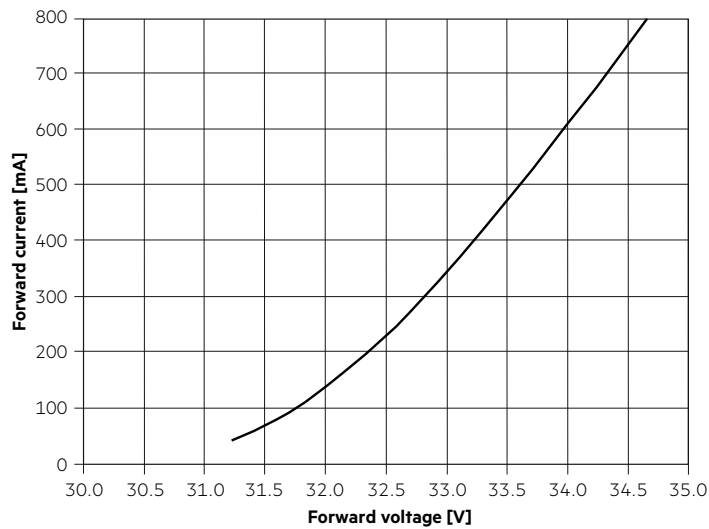

The diagrams are based on statistic values.
The real values can be different.

5.3 Forward voltage vs. tc temperature

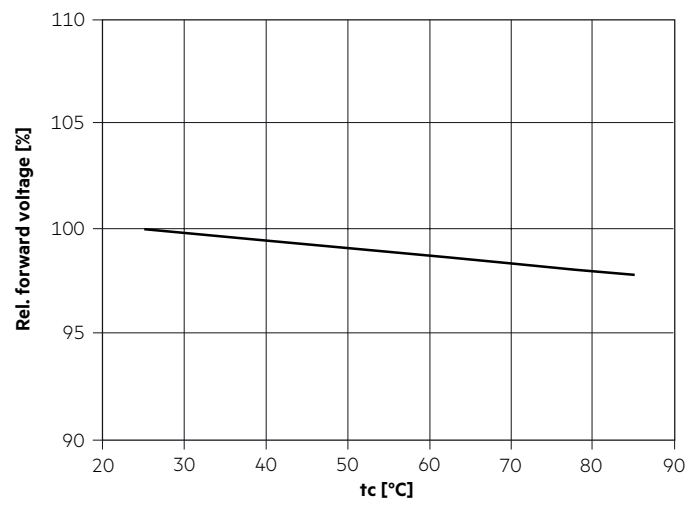

The diagrams are based on statistic values.
The real values can be different.

6. Photometric characteristics

6.1 Coordinates and tolerances according to CIE 1931

The specified colour coordinates are integral measured by current impulse of 195 mA and a duration of 100 ms.
 The ambient temperature of the measurement is $t_a = 25^\circ\text{C}$.
 The measurement tolerance of the colour coordinates are ± 0.01 .

2,700 K

| | x0 | y0 |
|--------|--------|--------|
| Centre | 0.4578 | 0.4101 |

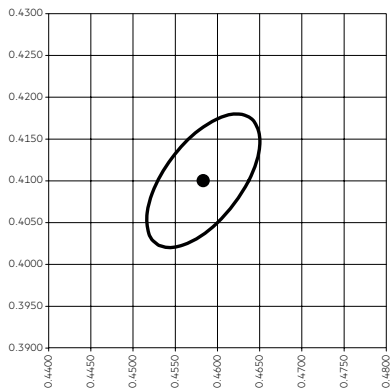

— MacAdam Ellipse: 3SDCM

| TM30 | | CRI | |
|------|----|-----|----|
| Rf | Rg | Ra | R9 |
| 91 | 99 | 93 | 57 |

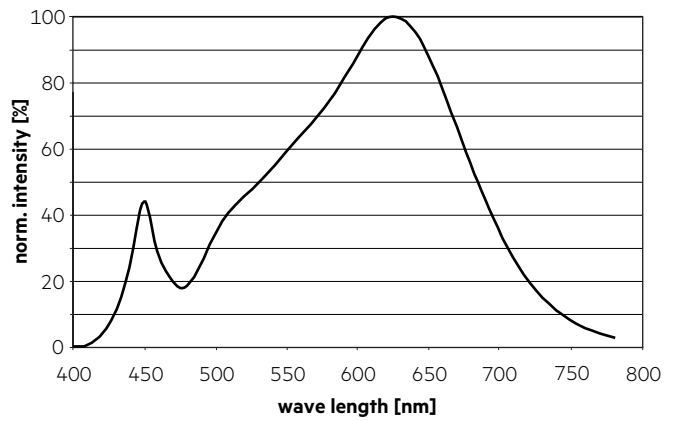

Colour vector graphic

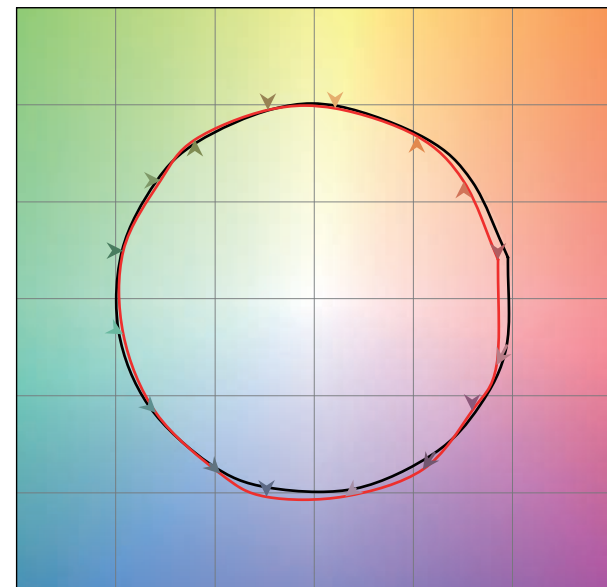

— Reference source
 — Test source

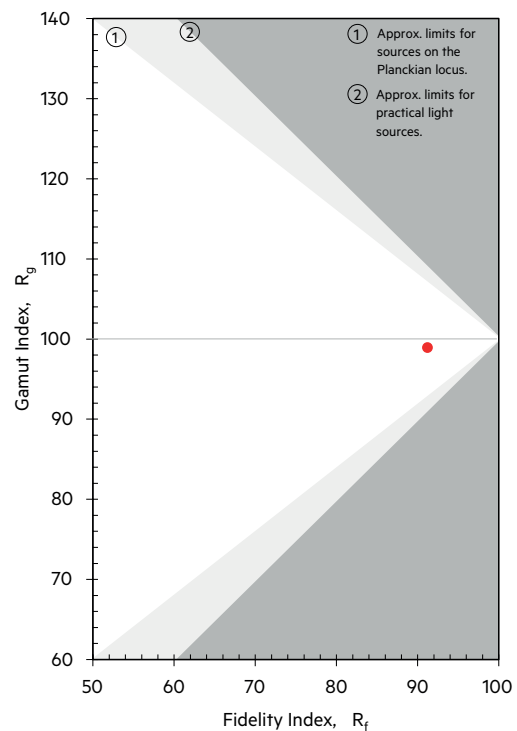

3,000 K

| | x0 | y0 |
|--------|--------|--------|
| Centre | 0.4338 | 0.4030 |

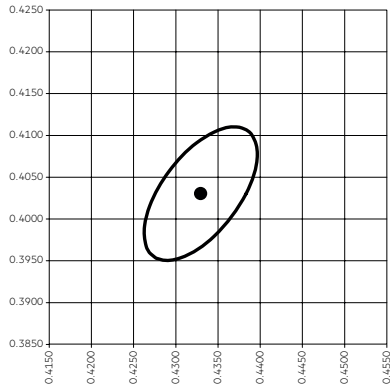

— MacAdam Ellipse: 3SDCM

| TM30 | | CRI | |
|------|----|-----|----|
| Rf | Rg | Ra | R9 |
| 90 | 98 | 92 | 57 |

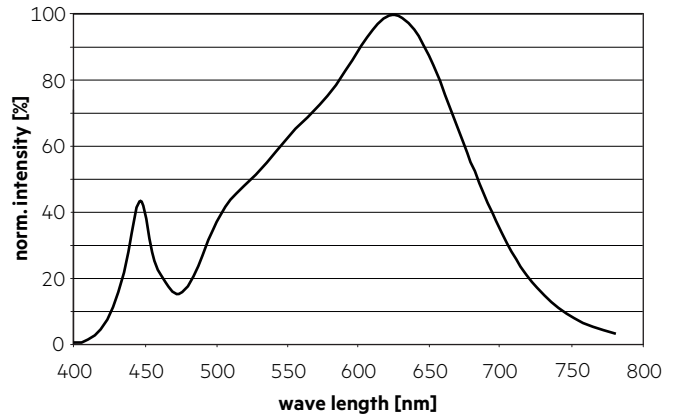

Colour vector graphic

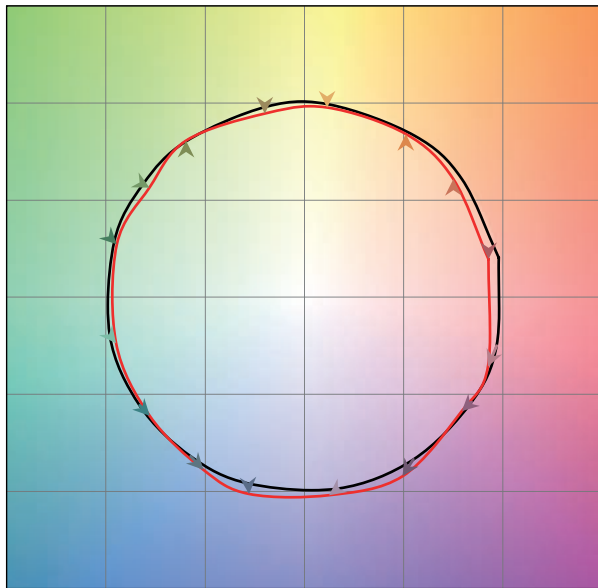

— Reference source
— Test source

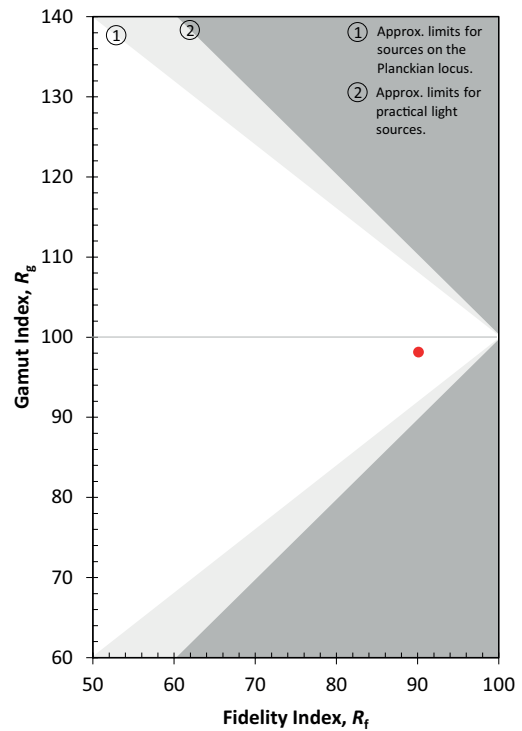

3,500 K

| | x0 | y0 |
|--------|--------|--------|
| Centre | 0.4073 | 0.3917 |

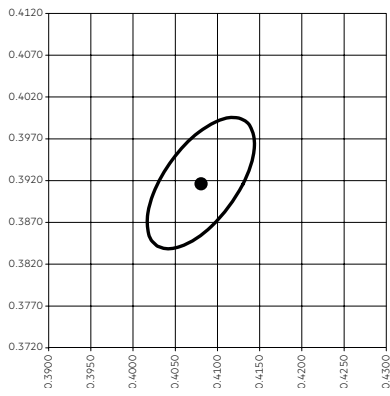

— MacAdam Ellipse: 3SDCM

| TM30 | | CRI | |
|------|----|-----|----|
| Rf | Rg | Ra | R9 |
| 90 | 99 | 93 | 63 |

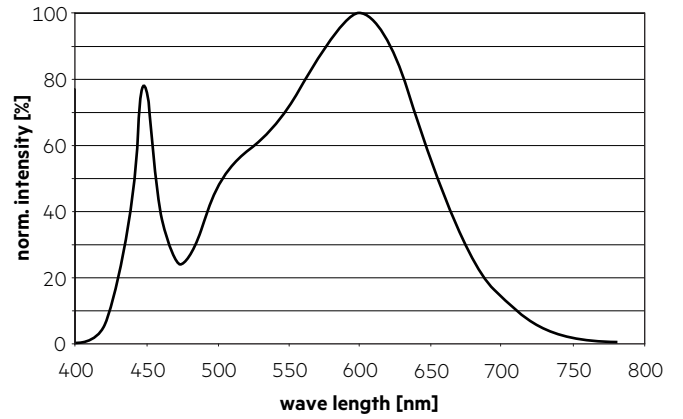

Colour vector graphic

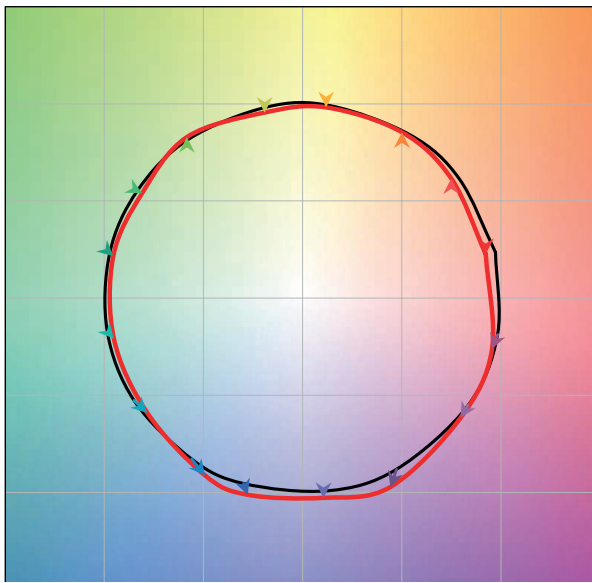

— Reference source
— Test source

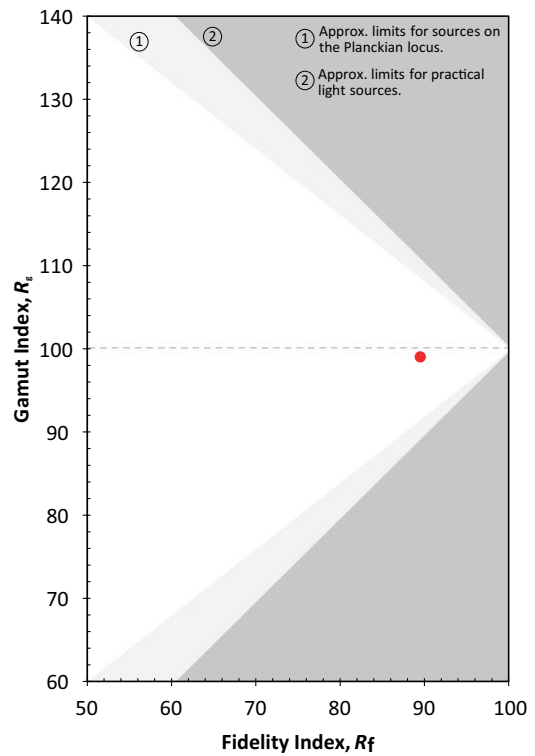

4,000 K

| | x0 | y0 |
|--------|--------|--------|
| Center | 0.3818 | 0.3797 |

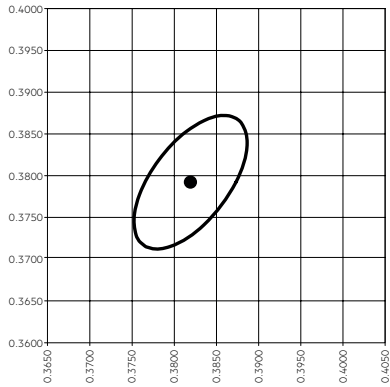

— MacAdam Ellipse: 3SDCM

| TM30 | | CRI | |
|------|----|-----|----|
| Rf | Rg | Ra | R9 |
| 89 | 99 | 91 | 54 |

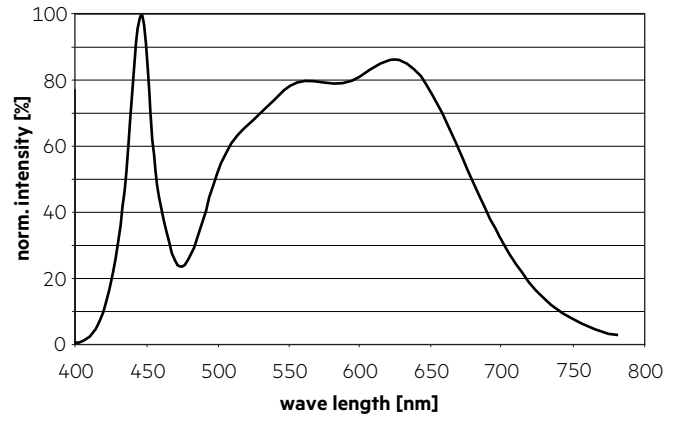

Colour vector graphic

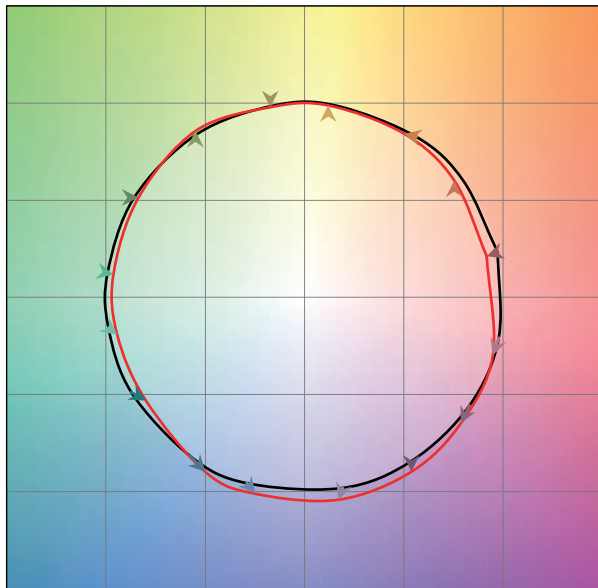

— Reference source
— Test source

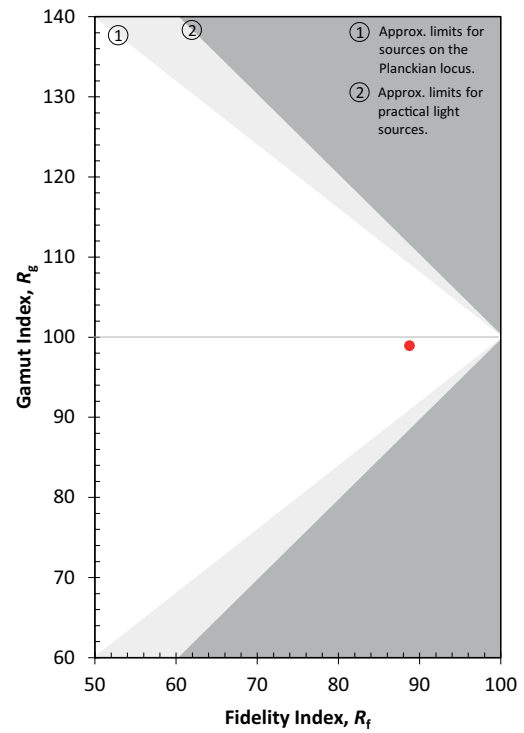

6.2 Light distribution

The optical design of the LLE product line ensures optimum homogeneity for the light distribution.

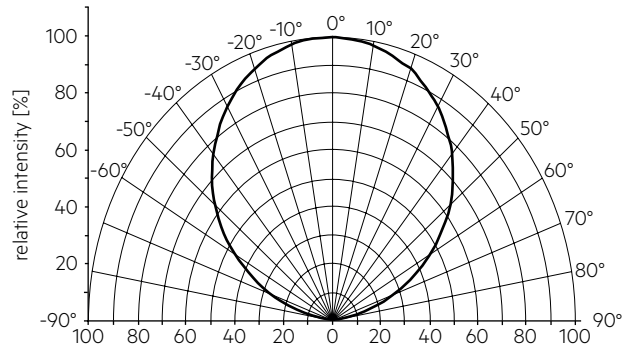

The colour temperature is measured integral over the complete module. The single LED light points can have deviations in the colour coordinates within MacAdam 3. To ensure an ideal mixture of colours and a homogeneous light distribution a suitable optic (e. g. PMMA diffuser) and a sufficient spacing between module and optic (typ. 4 cm) should be used.

6.3 Relative luminous flux vs. tc temperature

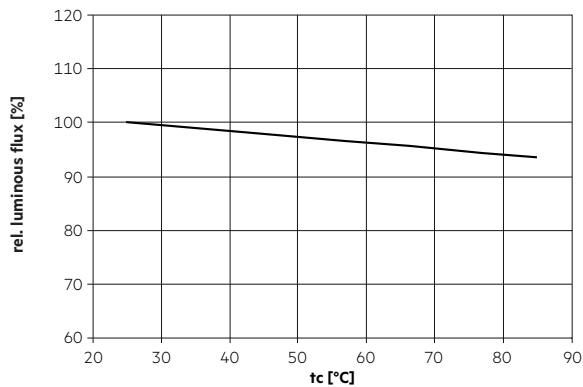

6.4 Relative luminous flux vs. operating current

LLE 24x140mm 650lm 9xx LV ADV6

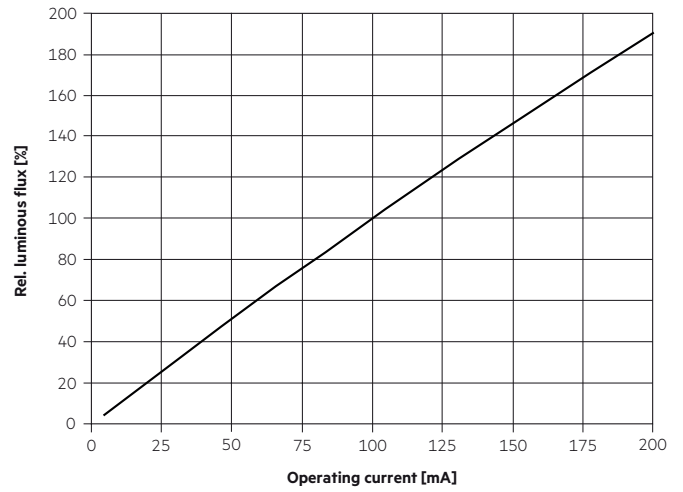

LLE 24x280mm 1250lm 9xx LV ADV6

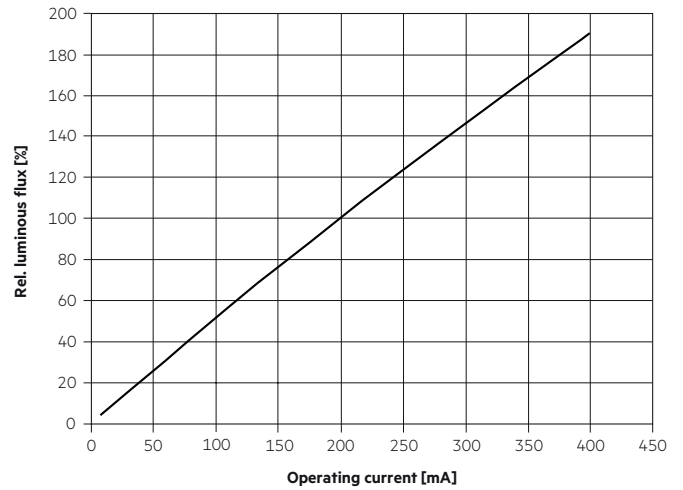

LLE 24x560mm 2400lm 9xx LV ADV6

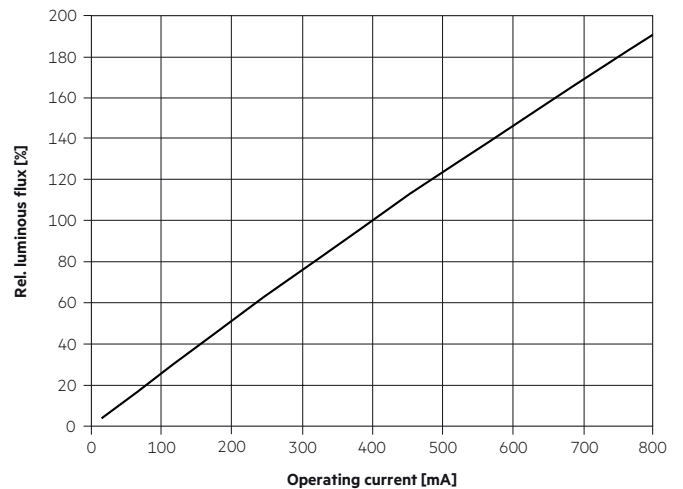

The diagrams are based on statistic values. The real values can be different.

7. Miscellaneous

7.1 Additional information

Additional technical information at www.tridonic.com → Technical Data

Guarantee conditions at www.tridonic.com → Services

Lifetime declarations are informative and represent no warranty claim.