

Module LLE 24mm 2000lm CRI90 HV ADV6

Modules LLE advanced



LLE 24x280mm 2000lm HV ADV6



LLE 24x560mm 4000lm HV ADV6



For articles manufactured at Tridonic SRB d.o.o.

Product description

- _ Ideal for linear and panel lights
- _ 2 terminals for serial wiring
- _ 4,000 K module COI approved acc. to AS/NZS1680.2.5:1997
- _ Perfectly uniform light, even if several LED modules are used together in a line
- _ Push terminals for quick and simple wiring of LED module to LED module
- _ Option backside terminal
- _ Broad portfolio from extruded lenses and covers available
- _ HE ... High Efficiency, NM ... Nominal Mode, HO ... High Output
- _ Long lifetime up to 72,000 hours
- _ 5 years guarantee (conditions at <https://www.tridonic.com/en/int/services/manufacturer-guarantee-conditions>)

Optical properties

- _ Colour temperatures 3,000 and 4,000 K
- _ Useful luminous flux 3,396 lm at Irated and tp = 25 °C
- _ Efficacy of the LED module 170 lm/W at Irated and tp = 25 °C
- _ High colour rendering index CRI > 90
- _ High colour consistency (MacAdam 3) ①
- _ Small luminous flux tolerances

Mechanical properties

- _ Module dimension 24 x 280 mm and 24 x 560 mm (ZHAGA compliant)
- _ Simple installation via clips or screws

System solution

- _ Combine Tridonic's LED modules and dimmable drivers to achieve an outstanding system efficacy (configuration possible via <https://setbuilder.tridonic.com/>)

① Integral measurement over the complete module.

Website

<http://www.tridonic.com/28004899>

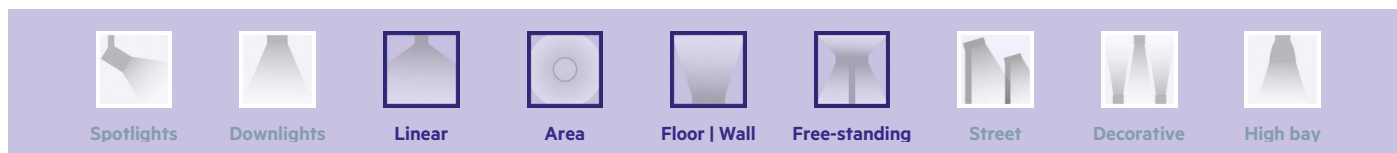
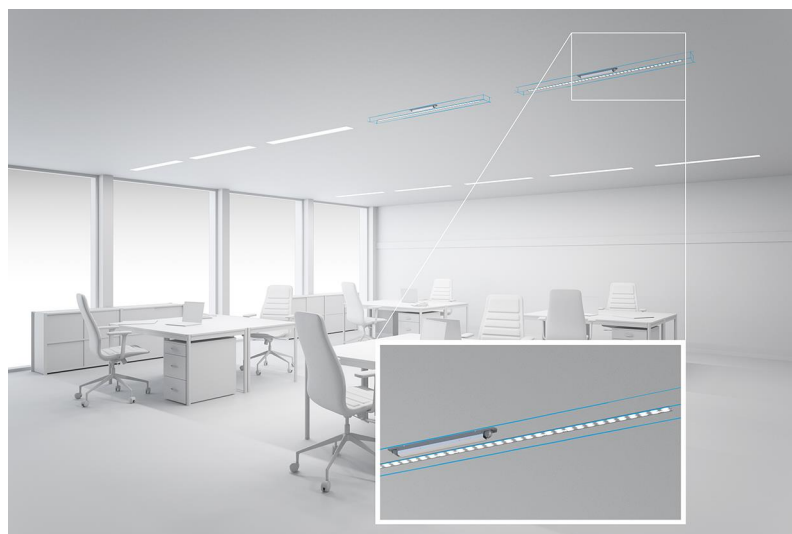

Module LLE 24mm 2000lm CRI90 HV ADV6

Modules LLE advanced

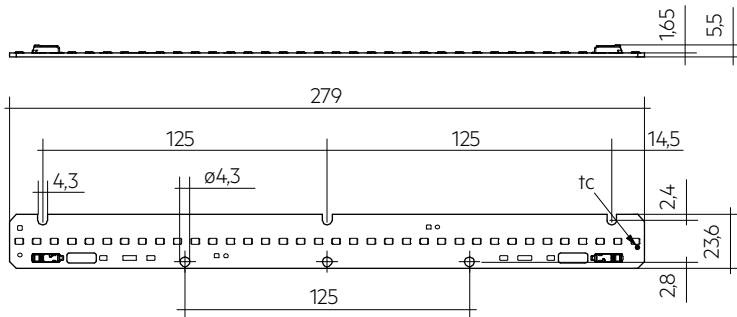

LLE 24x280mm 2000lm HV ADV6

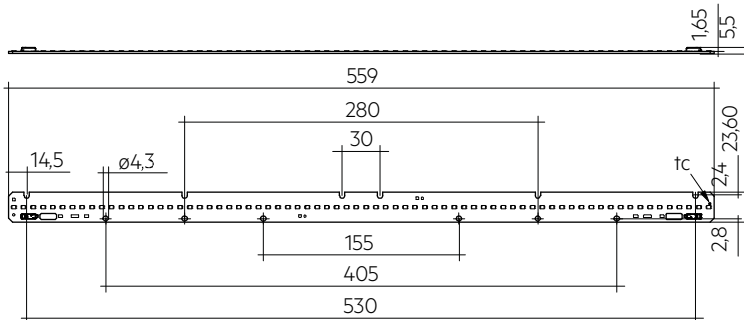

LLE 24x560mm 4000lm HV ADV6

Ordering data

Type	Article number	Colour temperature	Packaging, carton	Weight per pc.
LLE 24x280mm 2000lm 930 HV ADV6	28004899	3,000 K	108 pc(s).	0.023 kg
LLE 24x280mm 2000lm 940 HV ADV6	28004900	4,000 K	108 pc(s).	0.023 kg
LLE 24x560mm 4000lm 930 HV ADV6	28004906	3,000 K	108 pc(s).	0.041 kg
LLE 24x560mm 4000lm 940 HV ADV6	28004907	4,000 K	108 pc(s).	0.041 kg

Technical data

Beam characteristic	120°
Ambient temperature t_a	-40 ... +65 °C
t_p rated	50 °C
t_c	95 °C
I_{rated}	300 mA
I_{max}	700 mA
Max. permissible LF current ripple	800 mA
Max. permissible peak current	1,350 mA / max. 10 ms
Max. working voltage for insulation [®]	350 V
Insulation test voltage	1.7 kV
Colour tolerance	3 SDCM
ESD classification	Severity level 2
Risk group (IEC 62471)	RG1 (> 208 – 700 mA (I_{max})), RGO (\leq 208 mA)
Classification acc. to IEC 62031	Built-in
Type of protection	IP00
Lumen maintenance L70B50	72,000 h
Guarantee (conditions at www.tridonic.com)	5 Year(s)

Approval marks**Standards**

IEC 62031, IEC 62471, IEC 61000-4-2, IEC 62778, IEC 61547

Specific technical data

Type	Article number	Photometric code [®]	Useful luminous flux at $t_p = 25^\circ\text{C}$ ^④	Expected luminous flux at t_p rated ^⑤	Typ. forward current	Min. forward voltage at t_p rated	Max. forward voltage at $t_p = 25^\circ\text{C}$	Power consumption P_{on} at $t_p = 25^\circ\text{C}$ ^⑥	Efficacy of the module at $t_p = 25^\circ\text{C}$	Expected efficacy of the module at t_p rated	Colour rendering index CRI
Operating mode HE											
LLE 24x280mm 2000lm 930 HV ADV6	28004899	930/359	-	534 lm	100 mA	30.2 V	32.9 V	-	-	169 lm/W	>90
LLE 24x280mm 2000lm 940 HV ADV6	28004900	940/359	-	555 lm	100 mA	30.2 V	32.9 V	-	-	175 lm/W	>90
LLE 24x560mm 4000lm 930 HV ADV6	28004906	930/359	-	1,068 lm	100 mA	60.5 V	65.9 V	-	-	169 lm/W	>90
LLE 24x560mm 4000lm 940 HV ADV6	28004907	940/359	-	1,110 lm	100 mA	60.5 V	65.9 V	-	-	175 lm/W	>90
Operating mode NM											
LLE 24x280mm 2000lm 930 HV ADV6	28004899	930/359	1,633 lm	1,567 lm	300 mA	31.5 V	34.2 V	10.0 W	164 lm/W	159 lm/W	>90
LLE 24x280mm 2000lm 940 HV ADV6	28004900	940/359	1,698 lm	1,630 lm	300 mA	31.5 V	34.2 V	10.0 W	170 lm/W	165 lm/W	>90
LLE 24x560mm 4000lm 930 HV ADV6	28004906	930/359	3,267 lm	3,135 lm	300 mA	63.0 V	68.4 V	19.9 W	164 lm/W	159 lm/W	>90
LLE 24x560mm 4000lm 940 HV ADV6	28004907	940/359	3,396 lm	3,259 lm	300 mA	63.0 V	68.4 V	19.9 W	170 lm/W	165 lm/W	>90
Operating mode HO											
LLE 24x280mm 2000lm 930 HV ADV6	28004899	930/359	-	2,993 lm	600 mA	32.9 V	35.6 V	-	-	145 lm/W	>90
LLE 24x280mm 2000lm 940 HV ADV6	28004900	940/359	-	3,112 lm	600 mA	32.9 V	35.6 V	-	-	151 lm/W	>90
LLE 24x560mm 4000lm 930 HV ADV6	28004906	930/359	-	5,987 lm	600 mA	65.8 V	71.3 V	-	-	145 lm/W	>90
LLE 24x560mm 4000lm 940 HV ADV6	28004907	940/359	-	6,225 lm	600 mA	65.8 V	71.3 V	-	-	151 lm/W	>90

② If mounted with M4 screws with 7 mm head diameter.

③ The detailed explanation, see data sheet section 1.1.

④ Tolerance of useful light flux - 0 % / + 15 %. Measurement uncertainty \pm 10 %.⑤ Measurement uncertainty \pm 10 %. Based on calculation.⑥ Tolerance of power consumption P_{on} \pm 10 %. Measurement uncertainty \pm 5 %.

LINEAR COVER LLE

Accessory

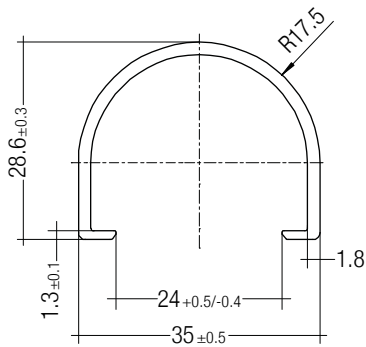

Product description

- _ LINEAR COVER for LLE
- _ Protection against direct touch for non-SELV applications (recommendation LLE 20: use all fixing points and screwed Endcap, recommendation LLE 24: use all fixing points)
- _ Fast snap on mounting on to LLE 20: with M4 screws and plastic washers, to LLE 24: with clips or plastic washers
- _ High transmission: transparent, semi-transparent and diffuse
- _ Material: PMMA
- _ Tolerances: ± 1 mm for 597 mm length (ends finished), + 10 mm from length 1,150 mm (ends raw)

Website

<http://www.tridonic.com/28000338>



Ordering data

Type	Article number	Colour	Length L	Efficiency	Packaging, carton	Weight per pc.
LINEAR COVER SY Transparent 1600mm	28000338	Transparent	1,600 mm	94 %	12 pc(s).	0.272 kg
LINEAR COVER SY Frosted 1800mm	28000437	Semi-transparent	1,800 mm	87 %	12 pc(s).	0.308 kg
LINEAR COVER SY Frosted 1600mm	28000339	Semi-transparent	1,600 mm	87 %	12 pc(s).	0.272 kg
LINEAR COVER SY Frosted 1500mm	28000435	Semi-transparent	1,500 mm	87 %	12 pc(s).	0.244 kg
LINEAR COVER SY Frosted 1200mm	28000422	Semi-transparent	1,200 mm	87 %	12 pc(s).	0.205 kg
LINEAR COVER SY Frosted 597mm	28000340	Semi-transparent	597 mm	87 %	12 pc(s).	0.102 kg
LINEAR COVER SY Diffuse 1800mm	28000438	Diffuse	1,800 mm	76 %	12 pc(s).	0.308 kg
LINEAR COVER SY Diffuse 1600mm	28000341	Diffuse	1,600 mm	76 %	12 pc(s).	0.272 kg
LINEAR COVER SY Diffuse 1500mm	28000436	Diffuse	1,500 mm	76 %	12 pc(s).	0.257 kg
LINEAR COVER SY Diffuse 1200mm	28000434	Diffuse	1,200 mm	76 %	12 pc(s).	0.205 kg
LINEAR COVER SY Diffuse 597mm	28000342	Diffuse	597 mm	76 %	12 pc(s).	0.102 kg

ACL ENDCAP LLE

Accessory

**Product description**

- _ ENDCAP for LLE
- _ PUSH-FIX: Fast snap on mounting (sheet thickness 0.5 – 1.0 mm), for drilling hole 4 mm
- _ SCREW-FIX: Screw mounting with EJOT Delta PT WN 5451 30x8 (not included), tightening torque 0.7 Nm
- _ Clip made of polycarbonate

Website

<http://www.tridonic.com/28001037>

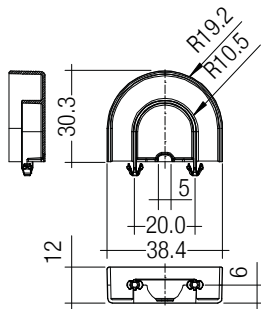
**Ordering data**

Type	Article number	Colour	Packaging, carton	Weight per pc.
ACL ENDCAP LLE24 PUSH-FIX	28001037	White	480 pc(s).	0.003 kg
ACL ENDCAP LLE24 SCREW-FIX	28002315	White	480 pc(s).	0.003 kg

ACL LINEAR LENS 24mm

Accessory

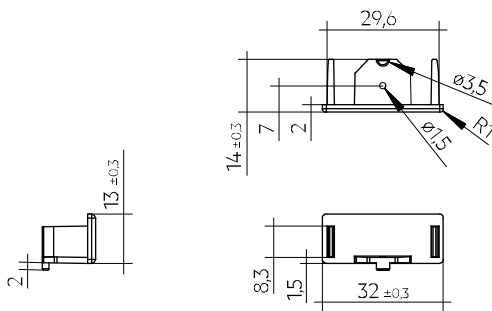
**Product description LINEAR LENS**

- _ Linear lens for LLE 20 / 24
- _ Available with different beam characteristics
- _ Protection against direct touch for non-SELV applications (recommendation: use all fixing points)
- _ Fast snap on mounting on to LLE 20: with M4 screws and plastic washers, to LLE 24: with clips or plastic washers
- _ Recommendation: Fastening with screws and plastic washers, see 2.3 Heat sink specifications in data sheet
- _ Material: PMMA
- _ Available lengths: 1,200, 1,500 and 1,800 mm, Tolerance: + 10 mm (ends raw)
- _ Max. permissible temperature 80 °C
- _ Photometric data available on website

Product description Endcap

- _ ENDCAP for LINEAR LENS 24mm INTENSE, ASY and DASY
- _ Mounting by clipping in and screwing from below using screw EJOT Delta PT WN 5451 20x4, tightening torque 0.7 Nm
- _ Made of Polyamide UL94 V0

Website

<http://www.tridonic.com/28001428>

**Ordering data**

Type	Article number	Length L	Beam characteristic	Efficiency	Packaging, carton	Weight per pc.
ACL LINEAR LENS 24x1200mm 60°	28001428	1,200 mm	60°	97 %	21 pc(s).	0.196 kg
ACL LINEAR LENS 24x1200mm 90°	28001429	1,200 mm	90°	97 %	21 pc(s).	0.165 kg
ACL LINEAR LENS 24x1500mm 60°	28000953	1,500 mm	60°	97 %	21 pc(s).	0.261 kg
ACL LINEAR LENS 24x1500mm 90°	28000955	1,500 mm	90°	97 %	21 pc(s).	0.221 kg
ACL LINEAR LENS 24x1200mm INTENSE	28002024	1,200 mm	40°	95 %	18 pc(s).	0.261 kg
ACL LINEAR LENS 24x1500mm INTENSE	28002025	1,500 mm	40°	95 %	18 pc(s).	0.326 kg
ACL LINEAR LENS 24x1800mm INTENSE	28002026	1,800 mm	40°	95 %	18 pc(s).	0.392 kg
ACL LINEAR LENS 24x1200mm BATWING	28002027	1,200 mm	batwing	95 %	18 pc(s).	0.275 kg
ACL LINEAR LENS 24x1500mm BATWING	28002028	1,500 mm	batwing	95 %	18 pc(s).	0.344 kg
ACL LINEAR LENS 24x1800mm BATWING	28002029	1,800 mm	batwing	95 %	18 pc(s).	0.412 kg
ACL LINEAR LENS 24x1200mm ASY	28002030	1,200 mm	asymmetric	95 %	18 pc(s).	0.250 kg
ACL LINEAR LENS 24x1500mm ASY	28002031	1,500 mm	asymmetric	95 %	18 pc(s).	0.312 kg
ACL LINEAR LENS 24x1800mm ASY	28002032	1,800 mm	asymmetric	95 %	18 pc(s).	0.375 kg
ACL LINEAR LENS 24x1200mm DASY	28002033	1,200 mm	double asymmetric	92 %	18 pc(s).	0.249 kg
ACL LINEAR LENS 24x1500mm DASY	28002034	1,500 mm	double asymmetric	92 %	18 pc(s).	0.311 kg
ACL LINEAR LENS 24x1800mm DASY	28002035	1,800 mm	double asymmetric	92 %	18 pc(s).	0.373 kg
ACL Endcap LENS 24mm PSF	28002669	-	-	-	3,600 pc(s).	0.003 kg

ACL CLIP 4.3mm

Accessory



Product description

- _ Clip for fixation of LED modules with 4.3 mm holes
- _ Fast snap on mounting (sheet thickness 0.5 – 1.0 mm for PUSH-FIX and 1 – 2 mm for PUSH-FIX Long)
- _ For drilling hole 4 mm
- _ Clip made of polycarbonate
- _ Minimum sales quantity 500 pcs.

Website

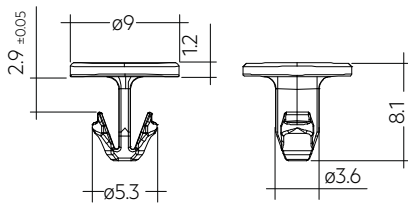
<http://www.tridonic.com/28001036>

Ordering data

Type	Article number	Colour	Packaging, bag ^①	Weight per pc.
ACL CLIP 4.3mm PUSH-FIX	28001036	White	500 pc(s).	0.001 kg
ACL CLIP 4,3mm PUSH-FIX Long	28002314	Transparent	500 pc(s).	0.001 kg

① Minimum sales quantity 500 pcs.

ACL BRIDGE LLE24/40

Accessory

**Product description**

- _ Enables the fixation of 24 mm wide Tridonic LED modules to fixtures made for 40 mm wide modules
- _ Ideal for extruded aluminium gear trays made for 40 mm modules with pre-alignment knobs
- _ Clip-on for LINEAR COVER and LINEAR LENS ^①
- _ For LLE 24 with 280 mm module minimum 2 bridges required
- _ For LLE 24 with 560 mm module minimum 3 bridges required
- _ Fixation via M3 or M4 countersunk screw, max. tightening torque 0.5 Nm
- _ Material: white polycarbonate
- _ Minimum sales quantity 600 pcs.

^① Beam characteristics will change due to the elevated fixation (see photometric files for details).

Website

<http://www.tridonic.com/28001205>

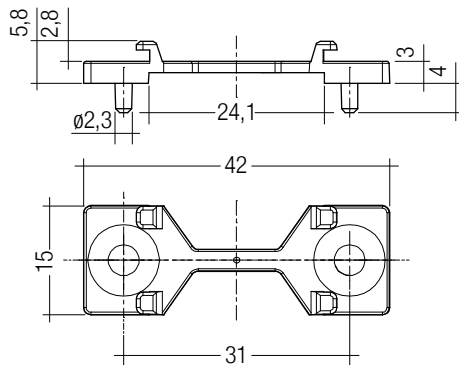
**Ordering data**

Type	Article number	Colour	Packaging, carton	Weight per pc.
ACL BRIDGE LLE24/40 SCREW-FIX	28001205	White	600 pc(s).	0.001 kg

1. Standards

IEC 62031
IEC 62471
IEC 61000-4-2
IEC 62778
IEC 61547

1.1 Photometric code

Key for photometric code, e. g. 830 / 349

1 st digit	2 nd + 3 rd digit	4 th digit	5 th digit	6 th digit
Code CRI	Colour temperature in Kelvin x 100	MacAdam initial	MacAdam after 25% of the lifetime (max.6000h)	Luminous flux after 25% of the lifetime (max.6000h)
7 70 – 79				Code Luminous flux
8 80 – 89				7 ≥ 70 %
9 ≥90				8 ≥ 80 % 9 ≥ 90 %

1.2 Risk group

Forward current	Risk group (IEC 62471)
≤ 208 mA	RG0
> 208 – 700 mA (Imax)	RG1

1.3 Energy classification

Type	Colour temperature	Forward current	Energy classification	Energy consumption
LLE 24x280mm 2000lm 930 HV ADV6	3,000 K	300 mA	D	10 kWh / 1,000 h
LLE 24x280mm 2000lm 940 HV ADV6	4,000 K	300 mA	D	10 kWh / 1,000 h
LLE 24x560mm 4000lm 930 HV ADV6	3,000 K	300 mA	D	20 kWh / 1,000 h
LLE 24x560mm 4000lm 940 HV ADV6	4,000 K	300 mA	D	20 kWh / 1,000 h

Energy label and further information at www.tridonic.com in the certificates tab of the corresponding product page and at the EPREL data base <https://eprel.ec.europa.eu/>

2. Thermal details

2.1 tc point, ambient temperature and lifetime

The temperature at tp reference point is crucial for the light output and lifetime of a LED product.

For LLE a tp temperature of 50 °C has to be complied in order to achieve an optimum between heat sink requirements, light output and lifetime.

Compliance with the maximum permissible reference temperature at the tc point must be checked under operating conditions in a thermally stable state. The maximum value must be determined under worst-case conditions for the relevant application.

The tc and tp temperature of LED modules from Tridonic are measured at the same reference point.

2.2 Storage and humidity

Storage temperature	-40...+80 °C
---------------------	--------------

Operation only in non condensing environment.

Humidity during processing of the module should be between 30 to 70 %.

2.3 Heat sink values

LLE 24x280mm 2000lm ADV6

ta	tp	Forward current	R _{th, hs-a}	Cooling area
25 °C	50 °C	300 mA	4.80 K/W	139 cm ²
25 °C	50 °C	600 mA	0.98 K/W	680 cm ²
35 °C	50 °C	300 mA	2.59 K/W	257 cm ²
35 °C	50 °C	600 mA	0.30 K/W	2,201 cm ²
40 °C	50 °C	300 mA	1.49 K/W	447 cm ²
45 °C	50 °C	300 mA	0.39 K/W	1,719 cm ²

LLE 24x560mm 4000lm ADV6

ta	tp	Forward current	R _{th, hs-a}	Cooling area
25 °C	50 °C	300 mA	2.40 K/W	278 cm ²
25 °C	50 °C	600 mA	0.49 K/W	1,359 cm ²
35 °C	50 °C	300 mA	1.30 K/W	514 cm ²
35 °C	50 °C	600 mA	0.15 K/W	4,402 cm ²
40 °C	50 °C	300 mA	0.74 K/W	895 cm ²
45 °C	50 °C	300 mA	0.19 K/W	3,438 cm ²

Notes

The actual cooling surface can differ because of the material, the structural shape, outside influences and the installation situation. Depending on the heat sink a heat conducting paste or heat conducting film might be necessary to keep the specified tp temperature.

For applications with a small distance between LED module and lens, screw mounting is recommended to ensure a reliable thermal connection between LED module and cooling surface.

3. Installation / wiring

3.1 Electrical supply/choice of LED driver

LLE modules from Tridonic are not protected against overvoltages, overcurrents, overloads or short-circuit currents. Safe and reliable operation can only be guaranteed in conjunction with a LED driver which complies with the relevant standards. The use of LED driver from Tridonic in combination with LLE modules guarantees the necessary protection for safe and reliable operation.

If a LED driver other than Tridonic is used, it must provide the following protection:

- Short-circuit protection
- Overload protection
- Overtemperature protection



LLE modules must be supplied by a constant current LED driver. Operation with a constant voltage LED driver will lead to an irreversible damage of the module.

Wrong polarity can damage the LLE.

The LLE module is designed for serial wiring.

LLE can be operated either from SELV LED drivers or from LED drivers with LV output voltage.



LLE are basic insulated up to 350 V (if mounted with M4 screws with head diameter 7 mm on a flat surface) against ground and can be mounted directly on earthed metal parts of the luminaire. The insulation is dependent on the mounting situation in the luminaire. The requirements for basic insulation must be ensured in the individual built-in situation. At voltages > 60 V an additional protection against direct touch (test finger) to the light emitting side of the module has to be guaranteed. This is typically achieved by means of a non removable light distributor over the module.

3.2 Wiring



Wiring example

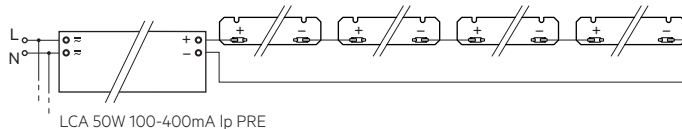

3.3 Wiring type and cross section

For wiring use stranded wire with ferrules or solid wire from 0.2 to 0.75 mm². For the push-wire connection you have to strip the insulation (8–9 mm).

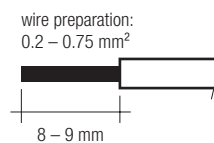

To remove the wires use a suitabel tool (e.g. Microcon release pin) or through twist and pull.

3.4 Mounting instruction



None of the components of the LLE (substrate, LED, electronic components etc.) may be exposed to tensile or compressive stresses.

Max. torque for fixing: 0.5 Nm.

The LED modules are mounted onto a heat sink with min. 12 screws per module or ACL CLIP 4.3mm.



Chemical substance may harm the LED module. Chemical reactions could lead to colour shift, reduced luminous flux or a total failure of the module caused by corrosion of electrical connections.

Materials which are used in LED applications (e.g. sealings, adhesives) must not produce dissolver gas. They must not be condensation curing based, acetate curing based or contain sulfur, chlorine or phthalate.

Avoid corrosive atmosphere during usage and storage.

3.5 EOS/ESD safety guidelines



The device / module contains components that are sensitive to electrostatic discharge and may only be installed in the factory and on site if appropriate EOS/ESD protection measures have been taken. No special measures need be taken for devices/modules with enclosed casings (contact with the pc board not possible), just normal installation practice. Please note the requirements set out in the document EOS / ESD guidelines (Guideline_EOS_ESD.pdf) at: <http://www.tridonic.com/esd-protection>

4. Lifetime

4.1 Lifetime, lumen maintenance and failure rate

The light output of an LED module decreases over the lifetime, this is characterized with the L value.

L70 means that the LED module will give 70 % of its initial luminous flux.

This value is always related to the number of operation hours and therefore defines the lifetime of an LED module.

As the L value is a statistical value and the lumen maintenance may vary over the delivered LED modules.

The B value defines the amount of modules which are below the specific L value, e.g. L70B10 means 10 % of the LED modules are below 70 % of the initial luminous flux, respectively 90 % will be above 70 % of the initial value.

In addition the percentage of failed modules (fatal failure) is characterized by the C value.

4.2 Lumen maintenance for LLE 24mm HV ADV6

Forward current	tp tempera- ture	L90 / B10 L90 / B50 L80 / B10 L80 / B50 L70 / B10 L70 / B50					
		100 mA	40 °C	>72k h	>72k h	>72k h	>72k h
	50 °C	>72k h	>72k h	>72k h	>72k h	>72k h	>72k h
	60 °C	>72k h	>72k h	>72k h	>72k h	>72k h	>72k h
	70 °C	>72k h	>72k h	>72k h	>72k h	>72k h	>72k h
	80 °C	>72k h	>72k h	>72k h	>72k h	>72k h	>72k h
	85 °C	>72k h	>72k h	>72k h	>72k h	>72k h	>72k h
275 mA	40 °C	61k h	>72k h	>72k h	>72k h	>72k h	>72k h
	50 °C	53k h	71k h	>72k h	>72k h	>72k h	>72k h
	60 °C	39k h	51k h	>72k h	>72k h	>72k h	>72k h
	70 °C	37k h	48k h	>72k h	>72k h	>72k h	>72k h
	80 °C	35k h	45k h	>72k h	>72k h	>72k h	>72k h
	85 °C	34k h	44k h	70k h	>72k h	>72k h	>72k h
600 mA	40 °C	54k h	>72k h	>72k h	>72k h	>72k h	>72k h
	50 °C	47k h	64k h	>72k h	>72k h	>72k h	>72k h
	60 °C	41k h	55k h	>72k h	>72k h	>72k h	>72k h
	70 °C	36k h	48k h	>72k h	>72k h	>72k h	>72k h
	80 °C	31k h	42k h	>72k h	>72k h	>72k h	>72k h
	85 °C	29k h	40k h	>72k h	>72k h	>72k h	>72k h

L0C10 >72k h. At tp rated, based on 10 swiching cycles per day.

4.3 Switching capability

100,000 cycles

Tridonic test according to IEC 62717 Cl 10.3.3

30 s on / 30 s off at Imax

5. Electrical values

5.1 Declaration of electrical parameters

I_{rated} ... Nominal operating current the module is designed for.

I_{max} ... Max. permissible continuous operating current incl. The tolerances of the LED driver.

Max. permissible LF current ripple ... Max. output current of the LED driver incl. Tolerances and LF current ripple must not exceed this value.

Max. permissible peak current ... The max. output peak current of the LED driver must not exceed this value.

5.2 Typ. forward voltage vs. forward current

LLE 24x280mm 2000lm 9xx HV ADV6

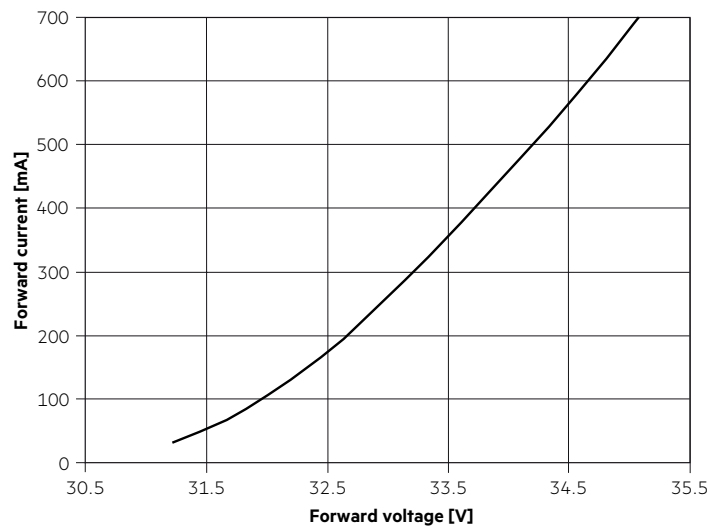

LLE 24x560mm 4000lm 9xx HV ADV6

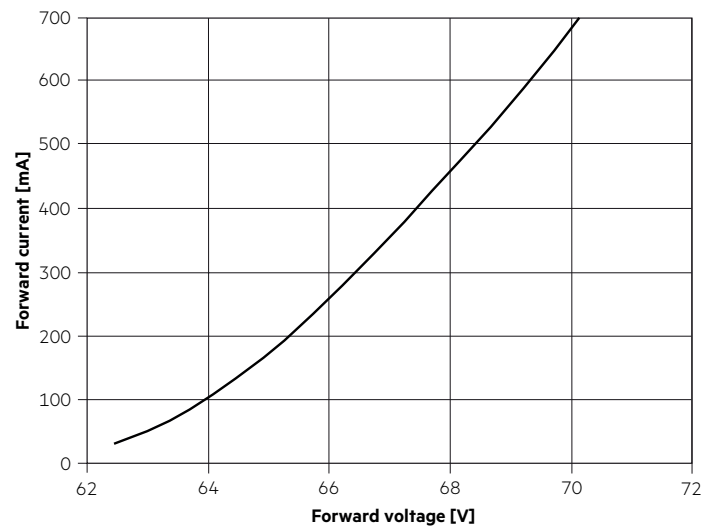

5.3 Forward voltage vs. tc temperature

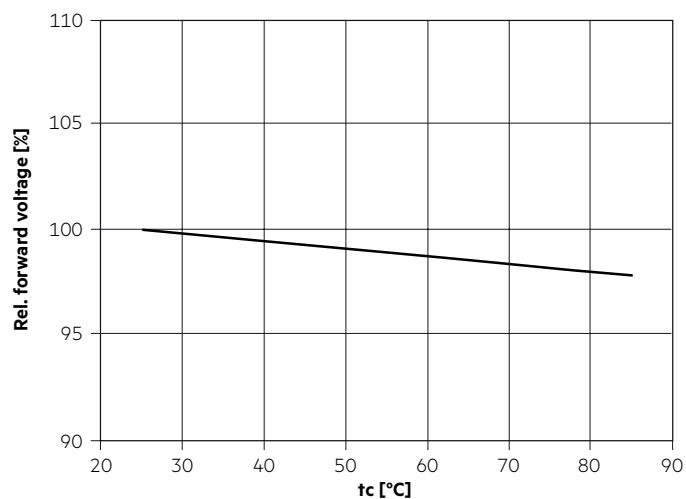

The diagrams are based on statistic values.
The real values can be different.

6. Photometric characteristics

6.1 Coordinates and tolerances according to CIE 1931

The specified colour coordinates are integral measured by current impulse of 195 mA and a duration of 100 ms.
 The ambient temperature of the measurement is $t_a = 25^\circ\text{C}$.
 The measurement tolerance of the colour coordinates are ± 0.01 .

3,000 K

	x0	y0
Centre	0.4338	0.4030

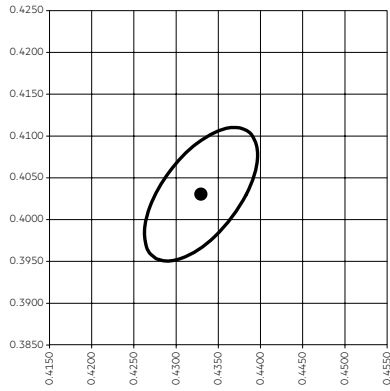

— MacAdam Ellipse: 3SDCM

TM30		CRI	
Rf	Rg	Ra	R9
90	98	92	57

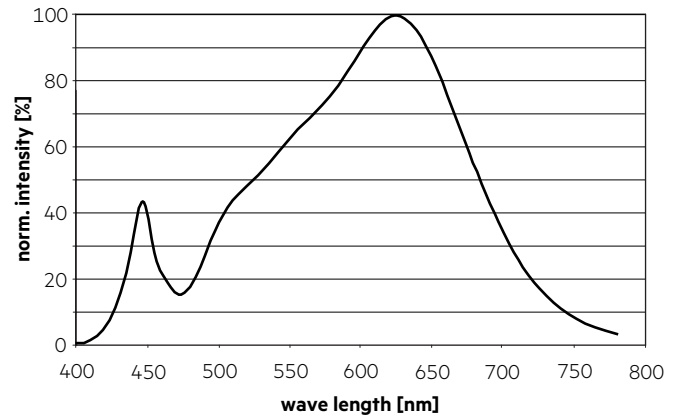

Colour vector graphic

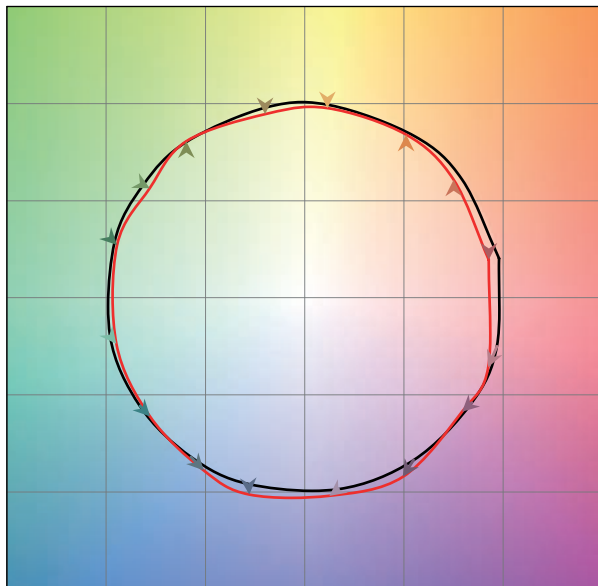

— Reference source
 — Test source

— MacAdam Ellipse: 3SDCM

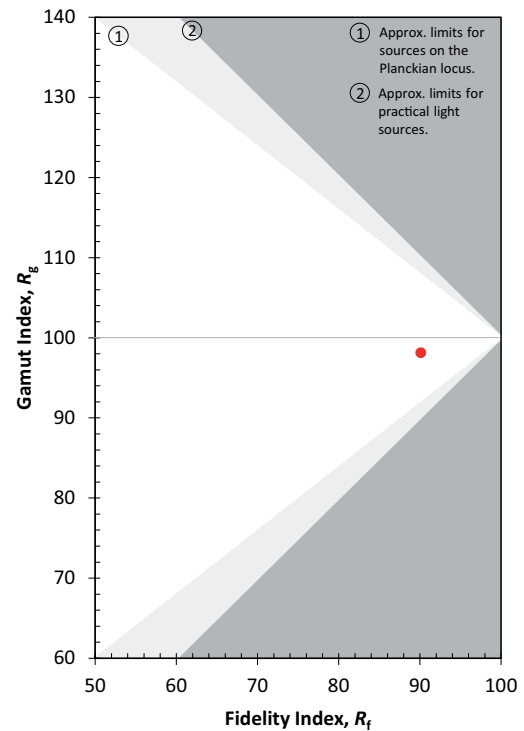

4,000 K

	x0	y0
Center	0.3818	0.3797

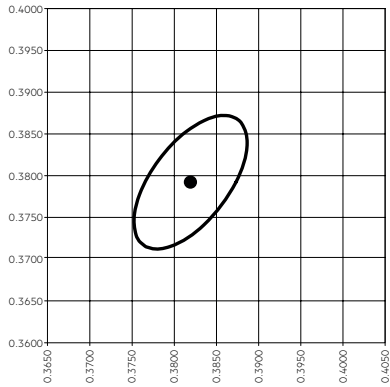

— MacAdam Ellipse: 3SDCM

TM30		CRI	
Rf	Rg	Ra	R9
89	99	91	54

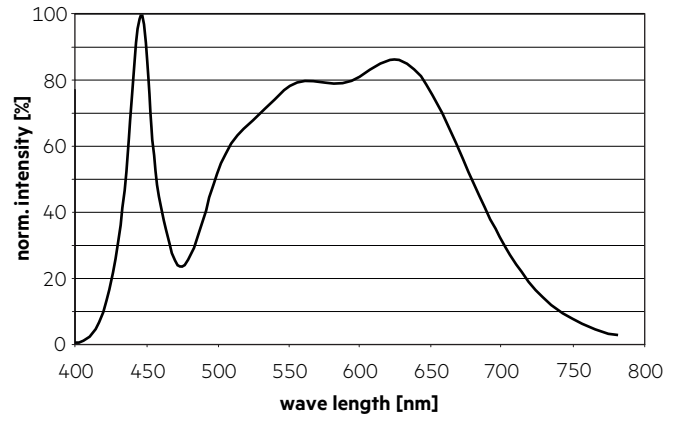

Colour vector graphic

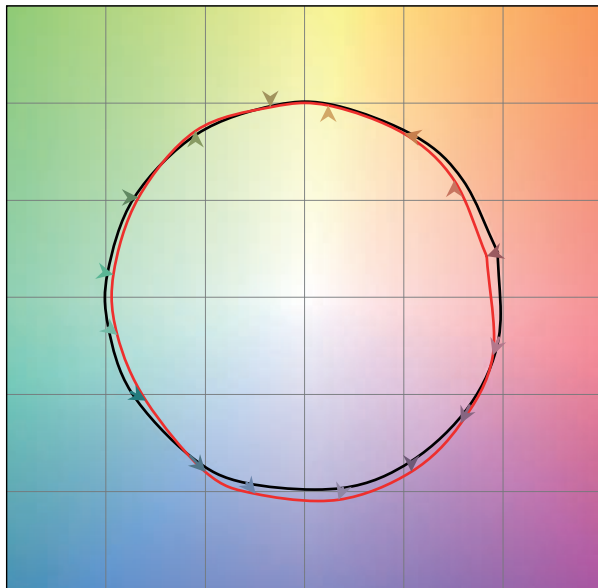

— Reference source
— Test source

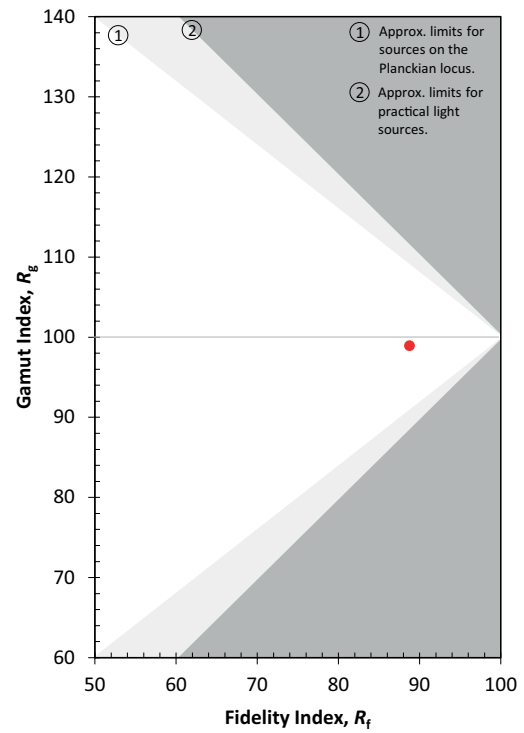

6.2 Light distribution

The optical design of the LLE product line ensures optimum homogeneity for the light distribution.

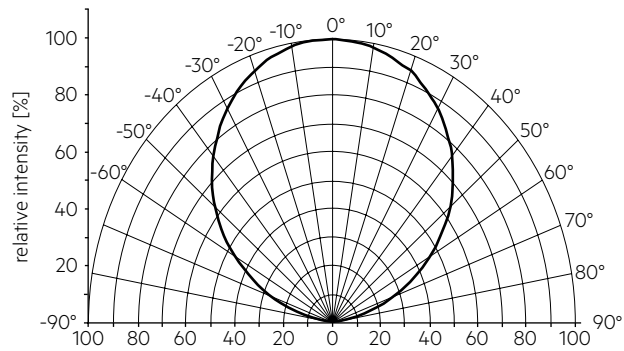

The colour temperature is measured integral over the complete module. The single LED light points can have deviations in the colour coordinates within MacAdam 5.

To ensure an ideal mixture of colours and a homogeneous light distribution a suitable optic (e. g. PMMA diffuser) and a sufficient spacing between module and optic (typ. 4 cm) should be used.

6.3 Relative luminous flux vs. tc temperature

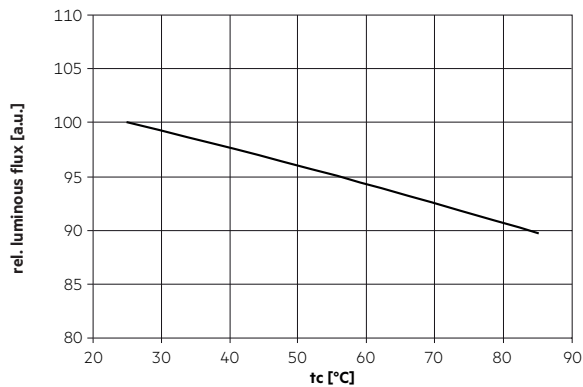

6.4 Relative luminous flux vs. operating current

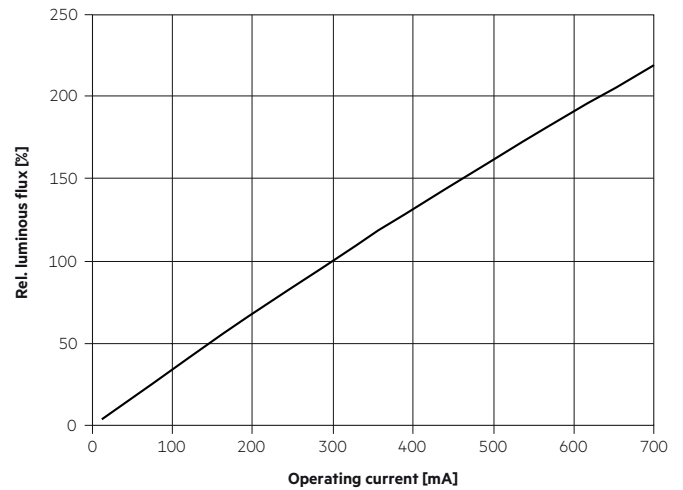

The diagrams are based on statistic values.
The real values can be different.

7. Miscellaneous

7.1 Additional information

Additional technical information at www.tridonic.com → Technical Data

Energy label and further information at www.tridonic.com in the certificates tab of the corresponding product page and at the EPREL data base <https://eprel.ec.europa.eu/>

Guarantee conditions at www.tridonic.com → Services

Lifetime declarations are informative and represent no warranty claim.