

Module LLE 16mm 1250lm HV ADV6

Modules LLE advanced



LLE 16x70mm 325lm HV ADV6



LLE 16x140mm 650lm HV ADV6



LLE 16x280mm 1250lm HV ADV6

Product description

- _ Ideal for compact linear luminaires designs
- _ Homogenous illumination thanks to small package distance
- _ 2 terminals for serial wiring
- _ Perfectly uniform light, even if several LED modules are used together in a line
- _ Push terminals for quick and simple wiring of LED module to LED module
- _ Min. order quantity LLE 16x70mm QTY4: 36 pcs. The LLE 16x70mm QTY4 module contains 4 single 16x70mm modules which have to be separated.
- _ HE ... High Efficiency, NM ... Nominal Mode, HO ... High Output
- _ Long lifetime up to 102,000 hours
- _ 5 years guarantee (conditions at <https://www.tridonic.com/en/int/services/manufacturer-guarantee-conditions>)

Optical properties

- _ Colour temperatures 2,700, 3,000, 3,500, 4,000, 5,000 and 6,500 K
- _ Efficacy of the LED module 205 lm/W at Irated and tp = 25 °C
- _ High colour rendering index CRI > 80
- _ High colour consistency (MacAdam 3) ^①
- _ Small luminous flux tolerances

Mechanical properties

- _ Module dimension 16 x 70 mm, 16 x 140 mm, 16 x 280 mm and 16 x 560 mm
- _ Simple installation via clips or screws

System solution

- _ Integrate compatible partner products into your final system solution: <https://www.tridonic.com/en/int/products/accessories#partner>
- _ Combine Tridonic's LED modules and dimmable drivers to achieve an outstanding system efficacy (configuration possible via <https://setbuilder.tridonic.com/>)

^① Integral measurement over the complete module.

Website

<http://www.tridonic.com/28004980>

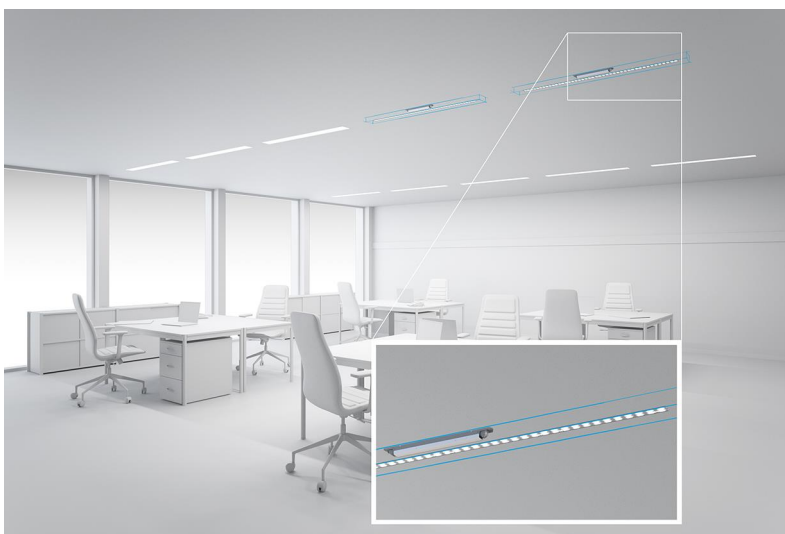

Spotlights



Downlights



Linear



Area



Floor | Wall



Free-standing



Street



Decorative



High bay

Module LLE 16mm 1250lm HV ADV6

Modules LLE advanced

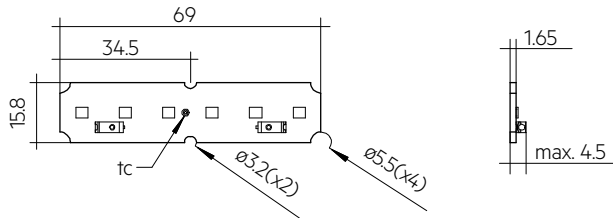
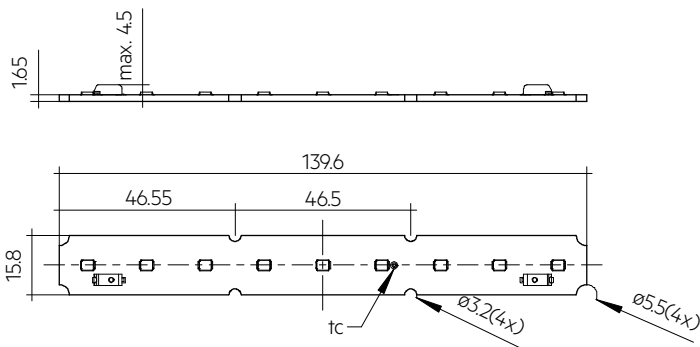
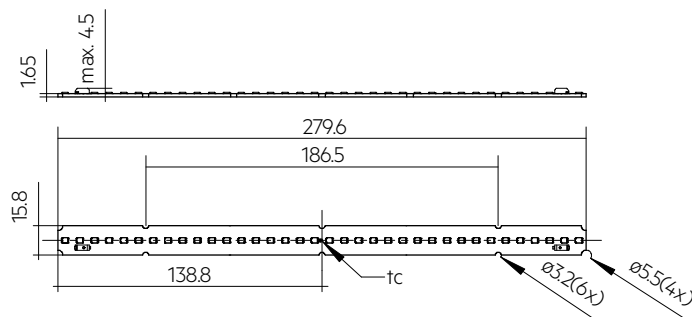
**LLE 16x70mm 325lm HV ADV6****LLE 16x140mm 650lm HV ADV6****LLE 16x280mm 1250lm HV ADV6**

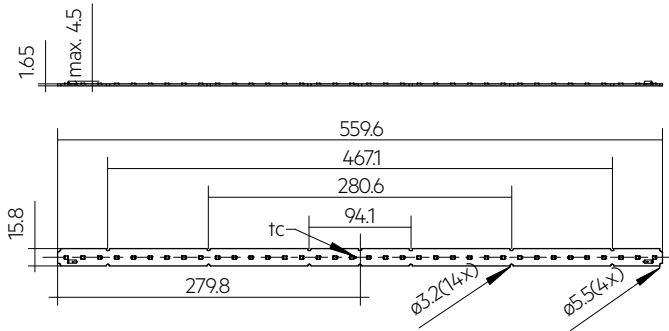

LLE 16x560mm 2400lm HV ADV6

Ordering data

Type	Article number	Colour temperature	Packaging, carton	Weight per pc.
LLE 16x70mm 325lm 830 HV ADV6 QTY4	28004980	3,000 K	144 pc(s).	0.017 kg
LLE 16x70mm 325lm 840 HV ADV6 QTY4	28004981	4,000 K	144 pc(s).	0.017 kg
LLE 16x140mm 650lm 827 HV ADV6	28004984	2,700 K	144 pc(s).	0.007 kg
LLE 16x140mm 650lm 830 HV ADV6	28004989	3,000 K	144 pc(s).	0.007 kg
LLE 16x140mm 650lm 835 HV ADV6	28004990	3,500 K	144 pc(s).	0.007 kg
LLE 16x140mm 650lm 840 HV ADV6	28004991	4,000 K	144 pc(s).	0.007 kg
LLE 16x140mm 650lm 850 HV ADV6	28004992	5,000 K	144 pc(s).	0.007 kg
LLE 16x140mm 650lm 865 HV ADV6	28004993	6,500 K	144 pc(s).	0.007 kg
LLE 16x280mm 1250lm 827 HV ADV6	28004998	2,700 K	144 pc(s).	0.014 kg
LLE 16x280mm 1250lm 830 HV ADV6	28004999	3,000 K	144 pc(s).	0.014 kg
LLE 16x280mm 1250lm 835 HV ADV6	28005002	3,500 K	144 pc(s).	0.014 kg
LLE 16x280mm 1250lm 840 HV ADV6	28005003	4,000 K	144 pc(s).	0.014 kg
LLE 16x280mm 1250lm 850 HV ADV6	28005004	5,000 K	144 pc(s).	0.014 kg
LLE 16x280mm 1250lm 865 HV ADV6	28005005	6,500 K	144 pc(s).	0.014 kg
LLE 16x560mm 2400lm 827 HV ADV6	28005010	2,700 K	144 pc(s).	0.028 kg
LLE 16x560mm 2400lm 830 HV ADV6	28005011	3,000 K	144 pc(s).	0.028 kg
LLE 16x560mm 2400lm 835 HV ADV6	28005012	3,500 K	144 pc(s).	0.028 kg
LLE 16x560mm 2400lm 840 HV ADV6	28005013	4,000 K	144 pc(s).	0.028 kg
LLE 16x560mm 2400lm 850 HV ADV6	28005014	5,000 K	144 pc(s).	0.028 kg
LLE 16x560mm 2400lm 865 HV ADV6	28005015	6,500 K	144 pc(s).	0.028 kg

Technical data

Beam characteristic	360°
Ambient temperature t_a	-40 ... +65 °C
t_p rated	50 °C
t_c	85 °C
I_{rated}	275 mA
I_{max}	700 mA
Max. permissible LF current ripple	800 mA
Max. permissible peak current	1,350 mA / max. 10 ms
Max. working voltage for insulation [®]	440 V
Insulation test voltage	1.88 kV
Colour tolerance	3 SDCM
ESD classification	Severity level 2
Risk group (IEC 62471)	RG1 (> 280 – 700 mA (I_{max})), RGO (\leq 280 mA)
Classification acc. to IEC 62031	Built-in
Type of protection	IP00
Lumen maintenance L70B50	102,000 h
Guarantee (conditions at www.tridonic.com)	5 Year(s)

Approval marks**Standards**

IEC 62031, IEC 62471, IEC 61000-4-2, IEC 62778, IEC 61547

Specific technical data

Type	Article number	Photometric code	Useful luminous flux at tp = 25 °C	Expected luminous flux at tp rated	Typ. forward current	Min. forward voltage at tp rated	Max. forward voltage at tp = 25 °C	Power consumption Pon at tp = 25 °C	Efficacy of the module at tp = 25 °C	Expected efficacy of the module at tp rated	Colour rendering index CRI
Operating mode HE											
LLE 16x70mm 325lm 830 HV ADV6 QTY4	28004980	830/359	-	104 lm	100 mA	5.0 V	5.5 V	-	-	197 lm/W	>80
LLE 16x70mm 325lm 840 HV ADV6 QTY4	28004981	840/359	-	110 lm	100 mA	5.0 V	5.5 V	-	-	209 lm/W	>80
LLE 16x140mm 650lm 827 HV ADV6	28004984	827/359	-	203 lm	100 mA	10.1 V	11.0 V	-	-	193 lm/W	>80
LLE 16x140mm 650lm 830 HV ADV6	28004989	830/359	-	208 lm	100 mA	10.1 V	11.0 V	-	-	197 lm/W	>80
LLE 16x140mm 650lm 835 HV ADV6	28004990	835/359	-	215 lm	100 mA	10.1 V	11.0 V	-	-	204 lm/W	>80
LLE 16x140mm 650lm 840 HV ADV6	28004991	840/359	-	221 lm	100 mA	10.1 V	11.0 V	-	-	209 lm/W	>80
LLE 16x140mm 650lm 850 HV ADV6	28004992	850/359	-	219 lm	100 mA	10.1 V	11.0 V	-	-	208 lm/W	>80
LLE 16x140mm 650lm 865 HV ADV6	28004993	865/359	-	216 lm	100 mA	10.1 V	11.0 V	-	-	205 lm/W	>80
LLE 16x280mm 1250lm 827 HV ADV6	28004998	827/359	-	407 lm	100 mA	20.2 V	22.0 V	-	-	193 lm/W	>80
LLE 16x280mm 1250lm 830 HV ADV6	28004999	830/359	-	416 lm	100 mA	20.2 V	22.0 V	-	-	197 lm/W	>80
LLE 16x280mm 1250lm 835 HV ADV6	28005002	835/359	-	430 lm	100 mA	20.2 V	22.0 V	-	-	204 lm/W	>80
LLE 16x280mm 1250lm 840 HV ADV6	28005003	840/359	-	442 lm	100 mA	20.2 V	22.0 V	-	-	209 lm/W	>80
LLE 16x280mm 1250lm 850 HV ADV6	28005004	850/359	-	439 lm	100 mA	20.2 V	22.0 V	-	-	208 lm/W	>80
LLE 16x280mm 1250lm 865 HV ADV6	28005005	865/359	-	433 lm	100 mA	20.2 V	22.0 V	-	-	205 lm/W	>80
LLE 16x560mm 2400lm 827 HV ADV6	28005010	827/359	-	814 lm	100 mA	40.3 V	43.9 V	-	-	193 lm/W	>80
LLE 16x560mm 2400lm 830 HV ADV6	28005011	830/359	-	832 lm	100 mA	40.3 V	43.9 V	-	-	197 lm/W	>80
LLE 16x560mm 2400lm 835 HV ADV6	28005012	835/359	-	861 lm	100 mA	40.3 V	43.9 V	-	-	204 lm/W	>80
LLE 16x560mm 2400lm 840 HV ADV6	28005013	840/359	-	883 lm	100 mA	40.3 V	43.9 V	-	-	209 lm/W	>80
LLE 16x560mm 2400lm 850 HV ADV6	28005014	850/359	-	877 lm	100 mA	40.3 V	43.9 V	-	-	208 lm/W	>80
LLE 16x560mm 2400lm 865 HV ADV6	28005015	865/359	-	866 lm	100 mA	40.3 V	43.9 V	-	-	205 lm/W	>80
Operating mode NM											
LLE 16x70mm 325lm 830 HV ADV6 QTY4	28004980	830/359	293 lm	281 lm	275 mA	5.2 V	5.7 V	1.5 W	193 lm/W	187 lm/W	>80
LLE 16x70mm 325lm 840 HV ADV6 QTY4	28004981	840/359	310 lm	298 lm	275 mA	5.2 V	5.7 V	1.5 W	205 lm/W	198 lm/W	>80
LLE 16x140mm 650lm 827 HV ADV6	28004984	827/359	572 lm	549 lm	275 mA	10.4 V	11.4 V	3.0 W	188 lm/W	183 lm/W	>80
LLE 16x140mm 650lm 830 HV ADV6	28004989	830/359	585 lm	562 lm	275 mA	10.4 V	11.4 V	3.0 W	193 lm/W	187 lm/W	>80
LLE 16x140mm 650lm 835 HV ADV6	28004990	835/359	605 lm	581 lm	275 mA	10.4 V	11.4 V	3.0 W	199 lm/W	193 lm/W	>80
LLE 16x140mm 650lm 840 HV ADV6	28004991	840/359	621 lm	596 lm	275 mA	10.4 V	11.4 V	3.0 W	205 lm/W	198 lm/W	>80
LLE 16x140mm 650lm 850 HV ADV6	28004992	850/359	617 lm	592 lm	275 mA	10.4 V	11.4 V	3.0 W	203 lm/W	197 lm/W	>80
LLE 16x140mm 650lm 865 HV ADV6	28004993	865/359	608 lm	584 lm	275 mA	10.4 V	11.4 V	3.0 W	201 lm/W	194 lm/W	>80
LLE 16x280mm 1250lm 827 HV ADV6	28004998	827/359	1,144 lm	1,098 lm	275 mA	20.9 V	22.7 V	6.1 W	188 lm/W	183 lm/W	>80
LLE 16x280mm 1250lm 830 HV ADV6	28004999	830/359	1,170 lm	1,123 lm	275 mA	20.9 V	22.7 V	6.1 W	193 lm/W	187 lm/W	>80
LLE 16x280mm 1250lm 835 HV ADV6	28005002	835/359	1,210 lm	1,161 lm	275 mA	20.9 V	22.7 V	6.1 W	199 lm/W	193 lm/W	>80
LLE 16x280mm 1250lm 840 HV ADV6	28005003	840/359	1,241 lm	1,191 lm	275 mA	20.9 V	22.7 V	6.1 W	205 lm/W	198 lm/W	>80
LLE 16x280mm 1250lm 850 HV ADV6	28005004	850/359	1,233 lm	1,183 lm	275 mA	20.9 V	22.7 V	6.1 W	203 lm/W	197 lm/W	>80
LLE 16x280mm 1250lm 865 HV ADV6	28005005	865/359	1,219 lm	1,168 lm	275 mA	20.9 V	22.7 V	6.1 W	201 lm/W	194 lm/W	>80
LLE 16x560mm 2400lm 827 HV ADV6	28005010	827/359	2,287 lm	2,195 lm	275 mA	41.8 V	45.4 V	12.1 W	189 lm/W	183 lm/W	>80
LLE 16x560mm 2400lm 830 HV ADV6	28005011	830/359	2,340 lm	2,246 lm	275 mA	41.8 V	45.4 V	12.1 W	193 lm/W	187 lm/W	>80
LLE 16x560mm 2400lm 835 HV ADV6	28005012	835/359	2,420 lm	2,322 lm	275 mA	41.8 V	45.4 V	12.1 W	199 lm/W	193 lm/W	>80
LLE 16x560mm 2400lm 840 HV ADV6	28005013	840/359	2,482 lm	2,382 lm	275 mA	41.8 V	45.4 V	12.1 W	205 lm/W	198 lm/W	>80
LLE 16x560mm 2400lm 850 HV ADV6	28005014	850/359	2,466 lm	2,367 lm	275 mA	41.8 V	45.4 V	12.1 W	203 lm/W	197 lm/W	>80
LLE 16x560mm 2400lm 865 HV ADV6	28005015	865/359	2,433 lm	2,335 lm	275 mA	41.8 V	45.4 V	12.1 W	201 lm/W	194 lm/W	>80
Operating mode HO											
LLE 16x70mm 325lm 830 HV ADV6 QTY4	28004980	830/359	-	583 lm	600 mA	5.5 V	5.9 V	-	-	170 lm/W	>80
LLE 16x70mm 325lm 840 HV ADV6 QTY4	28004981	840/359	-	619 lm	600 mA	5.5 V	5.9 V	-	-	180 lm/W	>80
LLE 16x140mm 650lm 827 HV ADV6	28004984	827/359	-	1,140 lm	600 mA	11.0 V	11.9 V	-	-	166 lm/W	>80
LLE 16x140mm 650lm 830 HV ADV6	28004989	830/359	-	1,166 lm	600 mA	11.0 V	11.9 V	-	-	170 lm/W	>80
LLE 16x140mm 650lm 835 HV ADV6	28004990	835/359	-	1,206 lm	600 mA	11.0 V	11.9 V	-	-	176 lm/W	>80
LLE 16x140mm 650lm 840 HV ADV6	28004991	840/359	-	1,237 lm	600 mA	11.0 V	11.9 V	-	-	180 lm/W	>80
LLE 16x140mm 650lm 850 HV ADV6	28004992	850/359	-	1,229 lm	600 mA	11.0 V	11.9 V	-	-	179 lm/W	>80
LLE 16x140mm 650lm 865 HV ADV6	28004993	865/359	-	1,213 lm	600 mA	11.0 V	11.9 V	-	-	177 lm/W	>80
LLE 16x280mm 1250lm 827 HV ADV6	28004998	827/359	-	2,280 lm	600 mA	21.9 V	23.8 V	-	-	166 lm/W	>80
LLE 16x280mm 1250lm 830 HV ADV6	28004999	830/359	-	2,333 lm	600 mA	21.9 V	23.8 V	-	-	170 lm/W	>80
LLE 16x280mm 1250lm 835 HV ADV6	28005002	835/359	-	2,412 lm	600 mA	21.9 V	23.8 V	-	-	176 lm/W	>80
LLE 16x280mm 1250lm 840 HV ADV6	28005003	840/359	-	2,474 lm	600 mA	21.9 V	23.8 V	-	-	180 lm/W	>80
LLE 16x280mm 1250lm 850 HV ADV6	28005004	850/359	-	2,458 lm	600 mA	21.9 V	23.8 V	-	-	179 lm/W	>80
LLE 16x280mm 1250lm 865 HV ADV6	28005005	865/359	-	2,425 lm	600 mA	21.9 V	23.8 V	-	-	177 lm/W	>80
LLE 16x560mm 2400lm 827 HV ADV6	28005010	827/359	-	4,560 lm	600 mA	43.9 V	47.5 V	-	-	166 lm/W	>80
LLE 16x560mm 2400lm 830 HV ADV6	28005011	830/359	-	4,666 lm	600 mA	43.9 V	47.5 V	-	-	170 lm/W	>80
LLE 16x560mm 2400lm 835 HV ADV6	28005012	835/359	-	4,824 lm	600 mA	43.9 V	47.5 V	-	-	176 lm/W	>80
LLE 16x560mm 2400lm 840 HV ADV6	28005013	840/359	-	4,948 lm	600 mA	43.9 V	47.5 V	-	-	180 lm/W	>80
LLE 16x560mm 2400lm 850 HV ADV6	28005014	850/359	-	4,917 lm	600 mA	43.9 V	47.5 V	-	-	179 lm/W	>80
LLE 16x560mm 2400lm 865 HV ADV6	28005015	865/359	-	4,851 lm	600 mA	43.9 V	47.5 V	-	-	177 lm/W	>80

② If mounted with M3 screws with 6 mm head diameter and plastic washer.

③ The detailed explanation, see data sheet section 1.1.

④ Tolerance of useful light flux - 0 % / + 15 %. Measurement uncertainty ± 10 %.

⑤ Measurement uncertainty ± 10 %. Based on calculation.

⑥ Tolerance of power consumption Pon ± 10 %. Measurement uncertainty ± 5 %.

ACL BRIDGE LLE16

Accessory

**Product description**

- _ Clip for fixation for LLE16
- _ Fast snap on mounting (for sheet thickness 0.5 – 1.0 mm)
- _ For drilling hole 3 mm
- _ Clip made of polycarbonate
- _ Minimum sales quantity 200 pcs.

Website

<http://www.tridonic.com/28001035>

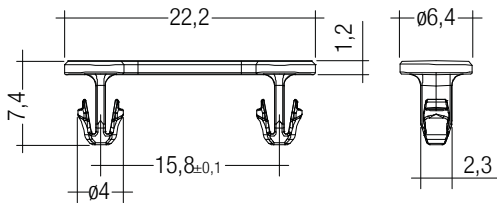
**Ordering data**

Type	Article number	Colour	Packaging, bag	Weight per pc.
ACL BRIDGE LLE16 PUSH-FIX	28001035	White	200 pc(s).	0.001 kg

ACL LINEAR COVER 16mm

Accessory

**Product description**

- _ LINEAR COVER for LLE 16
- _ Protection against direct touch for non-SELV applications (recommendation: use all fixing points) ^①
- _ Fast snap on mounting on to LLE 16 with clips or plastic washers
- _ High transmission: transparent, semi-transparent and diffuse
- _ Linear lense made of PMMA
- _ Tolerances LINEAR COVER: + 10 mm for 1,600 / 1,200 mm length (ends raw)

① Ends must be covered by the luminaire construction.

Website

<http://www.tridonic.com/28000950>

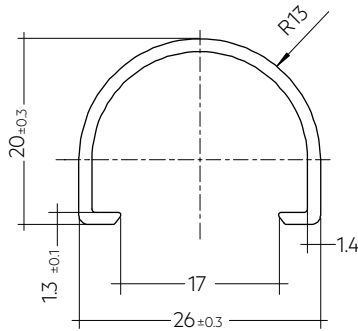
**Ordering data**

Type	Article number	Colour	Length L	Packaging, carton	Weight per pc.
ACL LINEAR COVER 16x1600mm FROSTED	28000950	Semi-transparent	1,600 mm	24 pc(s).	0.147 kg
ACL LINEAR COVER 16x1200mm FROSTED	28002827	Semi-transparent	1,200 mm	24 pc(s).	0.100 kg
ACL LINEAR COVER 16x1600mm DIFFUSE	28000951	Diffuse	1,600 mm	24 pc(s).	0.147 kg
ACL LINEAR COVER 16x1200mm DIFFUSE	28002828	Diffuse	1,200 mm	24 pc(s).	0.100 kg

1. Standards

IEC 62031
IEC 62471
IEC 61000-4-2
IEC 62778
IEC 61547

1.1 Photometric code

Key for photometric code, e. g. 830 / 349

1 st digit	2 nd + 3 rd digit	4 th digit	5 th digit	6 th digit
Code CRI	Colour temperature in Kelvin x 100	MacAdam initial	MacAdam after 25% of the lifetime (max.6000h)	Luminous flux after 25% of the lifetime (max.6000h)
7 70 – 79				Code Luminous flux
8 80 – 89				7 ≥ 70 %
9 ≥90				8 ≥ 80 % 9 ≥ 90 %

1.2 Risk group

Forward current	Risk group (IEC 62471)
≤ 280 mA	RG0
> 280 – 700 mA (Imax)	RG1

1.3 Energy classification

Type	Colour temperature	Forward current	Energy classification	Energy consumption
LLE 16x70mm 325lm 830 HV ADV6 QTY4	3,000 K	275 mA	C	2 kWh / 1,000 h
LLE 16x70mm 325lm 840 HV ADV6 QTY4	4,000 K	275 mA	B	2 kWh / 1,000 h
LLE 16x140mm 650lm 827 HV ADV6	2,700 K	275 mA	C	4 kWh / 1,000 h
LLE 16x140mm 650lm 830 HV ADV6	3,000 K	275 mA	C	4 kWh / 1,000 h
LLE 16x140mm 650lm 835 HV ADV6	3,500 K	275 mA	B	4 kWh / 1,000 h
LLE 16x140mm 650lm 840 HV ADV6	4,000 K	275 mA	B	4 kWh / 1,000 h
LLE 16x140mm 650lm 850 HV ADV6	5,000 K	275 mA	B	4 kWh / 1,000 h
LLE 16x140mm 650lm 865 HV ADV6	6,500 K	275 mA	B	4 kWh / 1,000 h
LLE 16x280mm 1250lm 827 HV ADV6	2,700 K	275 mA	C	7 kWh / 1,000 h
LLE 16x280mm 1250lm 830 HV ADV6	3,000 K	275 mA	C	7 kWh / 1,000 h
LLE 16x280mm 1250lm 835 HV ADV6	3,500 K	275 mA	C	7 kWh / 1,000 h
LLE 16x280mm 1250lm 840 HV ADV6	4,000 K	275 mA	B	7 kWh / 1,000 h
LLE 16x280mm 1250lm 850 HV ADV6	5,000 K	275 mA	B	7 kWh / 1,000 h
LLE 16x280mm 1250lm 865 HV ADV6	6,500 K	275 mA	C	7 kWh / 1,000 h
LLE 16x560mm 2400lm 827 HV ADV6	2,700 K	275 mA	C	13 kWh / 1,000 h
LLE 16x560mm 2400lm 830 HV ADV6	3,000 K	275 mA	C	13 kWh / 1,000 h
LLE 16x560mm 2400lm 835 HV ADV6	3,500 K	275 mA	B	13 kWh / 1,000 h
LLE 16x560mm 2400lm 840 HV ADV6	4,000 K	275 mA	B	13 kWh / 1,000 h
LLE 16x560mm 2400lm 850 HV ADV6	5,000 K	275 mA	B	13 kWh / 1,000 h
LLE 16x560mm 2400lm 865 HV ADV6	6,500 K	275 mA	B	13 kWh / 1,000 h

Energy label and further information at www.tridonic.com in the certificates tab of the corresponding product page and at the EPREL data base <https://eprel.ec.europa.eu/>

2. Thermal details

2.1 tc point, ambient temperature and lifetime

The temperature at tp reference point is crucial for the light output and lifetime of a LED product.

For LLE a tp temperature of 50 °C has to be complied in order to achieve an optimum between heat sink requirements, light output and lifetime.

Compliance with the maximum permissible reference temperature at the tc point must be checked under operating conditions in a thermally stable state. The maximum value must be determined under worst-case conditions for the relevant application.

The tc and tp temperature of LED modules from Tridonic are measured at the same reference point.

2.2 Storage and humidity

Storage temperature	-40... +85 °C
---------------------	---------------

Operation only in non condensing environment.

Humidity during processing of the module should be between 30 to 70 %.

2.3 Heat sink values

LLE 16x70mm 325lm ADV6

ta	tp	Forward current	R _{th, hs-a}	Cooling area
25 °C	50 °C	275 mA	3.775 K/W	18 cm ²
25 °C	50 °C	600 mA	9.59 K/W	70 cm ²
35 °C	50 °C	275 mA	20.94 K/W	32 cm ²
35 °C	50 °C	600 mA	4.04 K/W	165 cm ²
40 °C	50 °C	275 mA	12.53 K/W	53 cm ²
40 °C	50 °C	600 mA	1.26 K/W	528 cm ²
45 °C	50 °C	275 mA	4.12 K/W	162 cm ²

LLE 16x140mm 650lm ADV6

ta	tp	Forward current	R _{th, hs-a}	Cooling area
25 °C	50 °C	275 mA	18.88 K/W	35 cm ²
25 °C	50 °C	600 mA	4.79 K/W	139 cm ²
35 °C	50 °C	275 mA	10.47 K/W	64 cm ²
35 °C	50 °C	600 mA	2.02 K/W	330 cm ²
40 °C	50 °C	275 mA	6.26 K/W	106 cm ²
40 °C	50 °C	600 mA	0.63 K/W	1056 cm ²
45 °C	50 °C	275 mA	2.06 K/W	324 cm ²

LLE 16x280mm 1250lm ADV6

ta	tp	Forward current	R _{th, hs-a}	Cooling area
25 °C	50 °C	275 mA	9.44 K/W	71 cm ²
25 °C	50 °C	600 mA	2.40 K/W	278 cm ²
35 °C	50 °C	275 mA	5.23 K/W	127 cm ²
35 °C	50 °C	600 mA	1.01 K/W	661 cm ²
40 °C	50 °C	275 mA	3.13 K/W	213 cm ²
40 °C	50 °C	600 mA	0.32 K/W	2,111 cm ²
45 °C	50 °C	275 mA	1.03 K/W	647 cm ²

LLE 16x560mm 2400lm ADV6

ta	tp	Forward current	R _{th, hs-a}	Cooling area
25°C	50°C	275 mA	4.72 K/W	141 cm ²
25°C	50°C	600 mA	1.20 K/W	556 cm ²
35°C	50°C	275 mA	2.62 K/W	255 cm ²
35°C	50°C	600 mA	0.50 K/W	1,321 cm ²
40°C	50°C	275 mA	1.57 K/W	426 cm ²
40°C	50°C	600 mA	0.16 K/W	4,223 cm ²
45°C	50°C	275 mA	0.52 K/W	1,294 cm ²

Notes

The actual cooling surface can differ because of the material, the structural shape, outside influences and the installation situation. Depending on the heat sink a heat conducting paste or heat conducting film might be necessary to keep the specified tp temperature.

For applications with a small distance between LED module and lens or operating currents higher than 500 mA, screw mounting is recommended to ensure a reliable thermal connection between LED module and cooling surface.

3. Installation / wiring**3.1 Electrical supply/choice of LED driver**

LLE modules from Tridonic are not protected against overvoltages, overcurrents, overloads or short-circuit currents. Safe and reliable operation can only be guaranteed in conjunction with a LED driver which complies with the relevant standards. The use of LED driver from Tridonic in combination with LLE modules guarantees the necessary protection for safe and reliable operation.

If a LED driver other than Tridonic is used, it must provide the following protection:

- Short-circuit protection
- Overload protection
- Overtemperature protection



LLE modules must be supplied by a constant current LED driver. Operation with a constant voltage LED driver will lead to an irreversible damage of the module.

Wrong polarity can damage the LLE.

The LLE module is designed for serial wiring.

LLE can be operated either from SELV LED drivers or from LED drivers with LV output voltage.



LLE are basic insulated up to 440 V (if mounted with M3 screws with head diameter 6 mm in combination with plastic washers) against ground and can be mounted directly on earthed metal parts of the luminaire. If the max. output voltage of the LED driver (also against earth) is above 440 V, an additional insulation between LED module and heat sink is required (for example by insulated thermal pads) or by a suitable luminaire construction.

At voltages > 60 V an additional protection against direct touch (test finger) to the light emitting side of the module has to be guaranteed.

This is typically achieved by means of a non removable light distributor over the module.

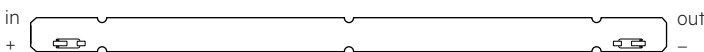
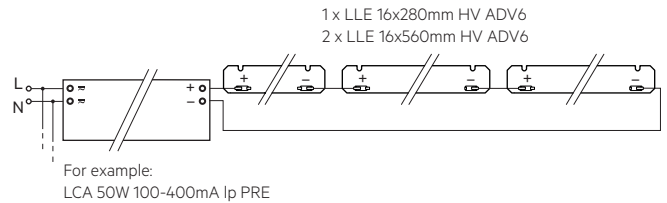
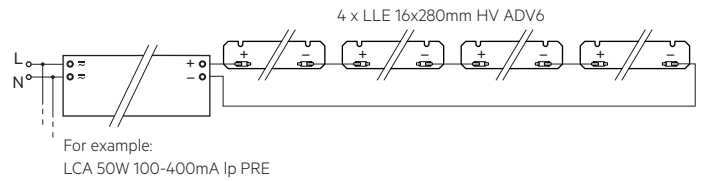
3.2 Wiring**Wiring examples for serial wiring****3.3 Wiring type and cross section**

For wiring use solid wire from 0.14 to 0.5 mm².

No reconnection with smaller diameters possible if used with >0.34 mm².

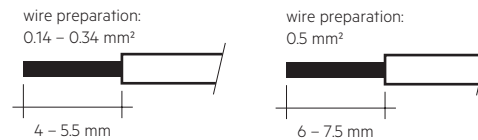

To remove the wires use a suitable tool (Wago 206-859) or through twist and pull.

3.4 Mounting instruction



None of the components of the LLE (substrate, LED, electronic components etc.) may be exposed to tensile or compressive stresses.

Max. torque for fixing: 0.5 Nm.

The LED modules are mounted onto a heat sink with M3 screws with plastic washers or ACL BRIDGE LLE16 PUSH-FIX.

All fastening point must be used for mounting.

The cut-outs on the end faces must not be used for fastening.

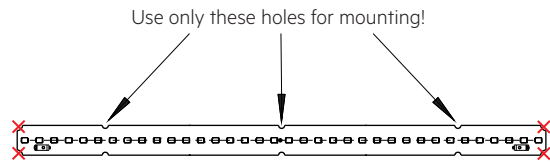

Only touch the module at the edge to separate the modules (see marking below).



Chemical substance may harm the LED module. Chemical reactions could lead to colour shift, reduced luminous flux or a total failure of the module caused by corrosion of electrical connections.

Materials which are used in LED applications (e.g. sealings, adhesives) must not produce dissolver gas. They must not be condensation curing based, acetate curing based or contain sulfur, chlorine or phthalate.

Avoid corrosive atmosphere during usage and storage.

3.5 EOS/ESD safety guidelines



The device / module contains components that are sensitive to electrostatic discharge and may only be installed in the factory and on site if appropriate EOS/ESD protection measures have been taken. No special measures need be taken for devices/modules with enclosed casings (contact with the pc board not possible), just normal installation practice. Please note the requirements set out in the document EOS / ESD guidelines (Guideline_EOS_ESD.pdf) at: <http://www.tridonic.com/esd-protection>

4. Lifetime

4.1 Lifetime, lumen maintenance and failure rate

The light output of an LED module decreases over the lifetime, this is characterized with the L value.

L70 means that the LED module will give 70 % of its initial luminous flux. This value is always related to the number of operation hours and therefore defines the lifetime of an LED module.

As the L value is a statistical value and the lumen maintenance may vary over the delivered LED modules.

The B value defines the amount of modules which are below the specific L value, e.g. L70B10 means 10 % of the LED modules are below 70 % of the initial luminous flux, respectively 90 % will be above 70 % of the initial value.

In addition the percentage of failed modules (fatal failure) is characterized by the C value.

The F value is the combination of the B and C value. That means for F degradation and complete failures are considered, e.g. L70F10 means 10 % of the LED modules may fail or be below 70 % of the initial luminous flux.

4.2 Lumen maintenance for LLE 16mm HV ADV6

Forward current	tp	L90 / B10	L90 / B50	L80 / B10	L80 / B50	L70 / B10	L70 / B50
	tempera- ture						
700 mA	55 °C	52k h	52k h	> 102k h	> 102k h	> 102k h	> 102k h
	85 °C	52k h	52k h	> 102k h	> 102k h	> 102k h	> 102k h

L00C03 >102k h. At tp rated and I rated, based on 10 switching cycles per day.

4.3 Switching capability

100,000 cycles

Tridonic test according to IEC 62717 Cl 10.3.3

30 s on / 30 s off at I_{max}

5. Electrical values

5.1 Declaration of electrical parameters

I_{rated} ... Nominal operating current the module is designed for.

I_{max} ... Max. permissible continuous operating current incl. The tolerances of the LED driver.

Max. permissible LF current ripple ... Max. output current of the LED driver incl. Tolerances and LF current ripple must not exceed this value.

Max. permissible peak current ... The max. output peak current of the LED driver must not exceed this value.

5.2 Typ. forward voltage vs. forward current

LLE 16x70mm 325lm 8xx HV ADV6

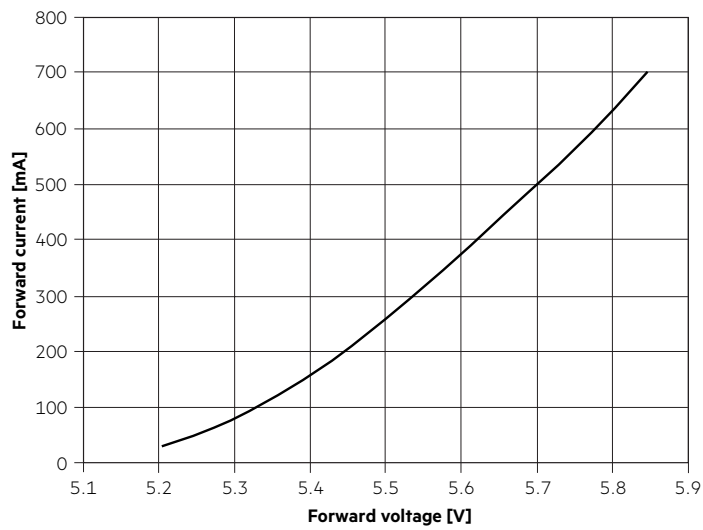

LLE 16x140mm 650lm 8xx HV ADV6

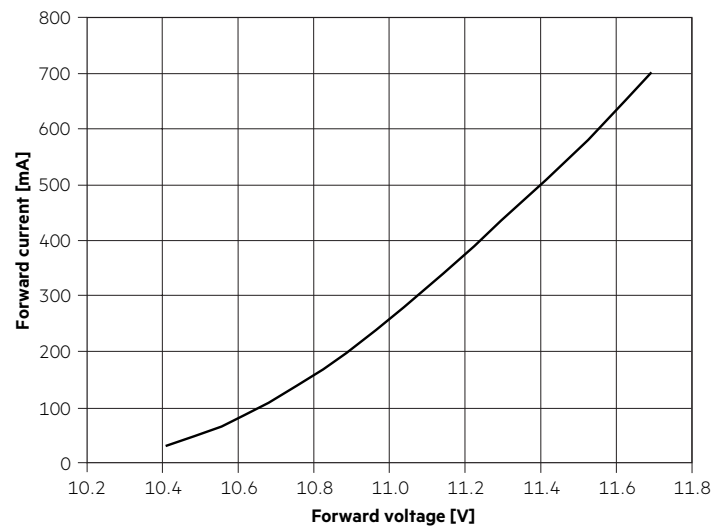

LLE 16x280mm 1250lm 8xx HV ADV6

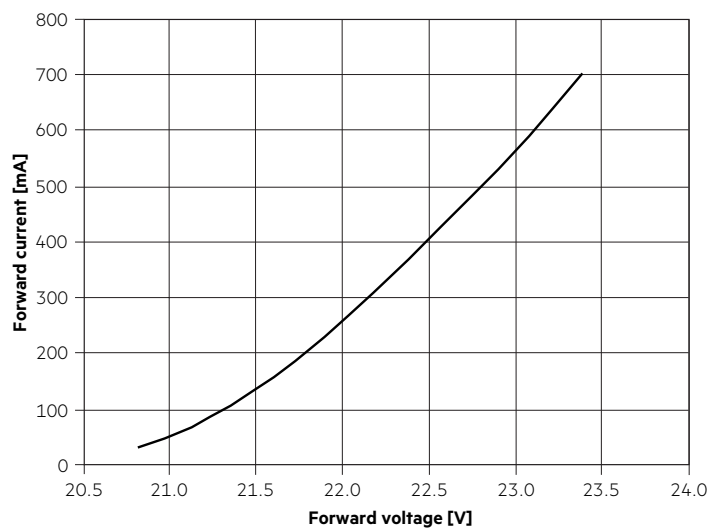

LLE 16x560mm 2400lm 8xx HV ADV6

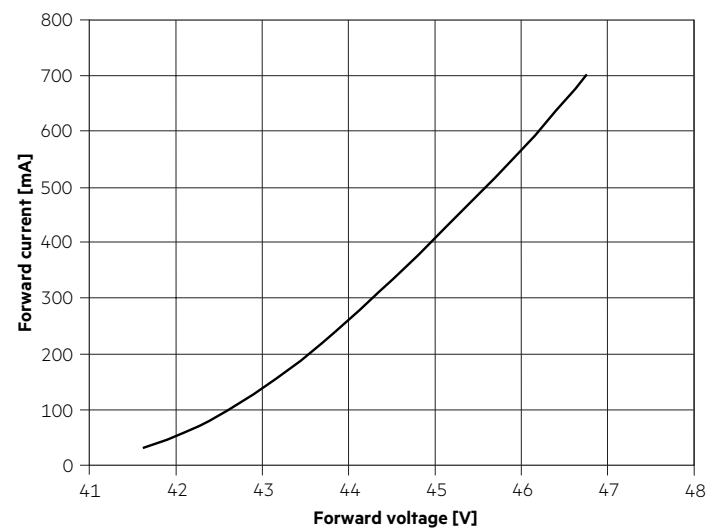

The diagrams are based on statistic values.
The real values can be different.

5.3 Forward voltage vs. tc temperature

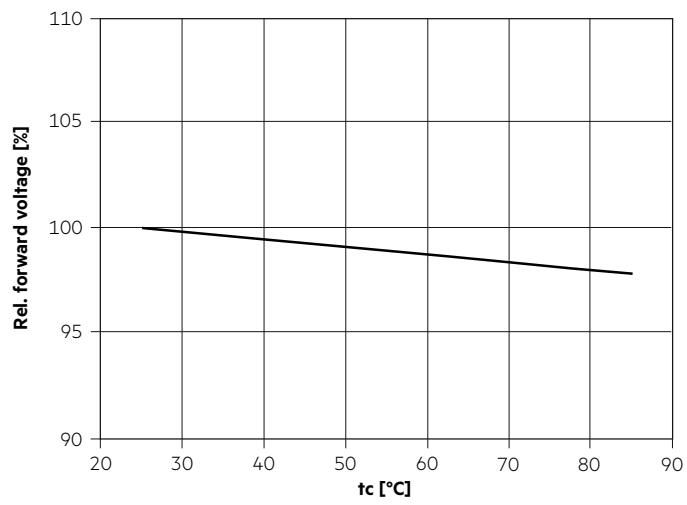

The diagrams are based on statistic values.
The real values can be different.

6. Photometric characteristics

6.1 Coordinates and tolerances according to CIE 1931

The specified colour coordinates are integral measured by current impulse of 195 mA and a duration of 100 ms.

The ambient temperature of the measurement is $t_a = 25^\circ\text{C}$.

The measurement tolerance of the colour coordinates are ± 0.01 .

2,700 K

	x0	y0
Centre	0.4578	0.4101

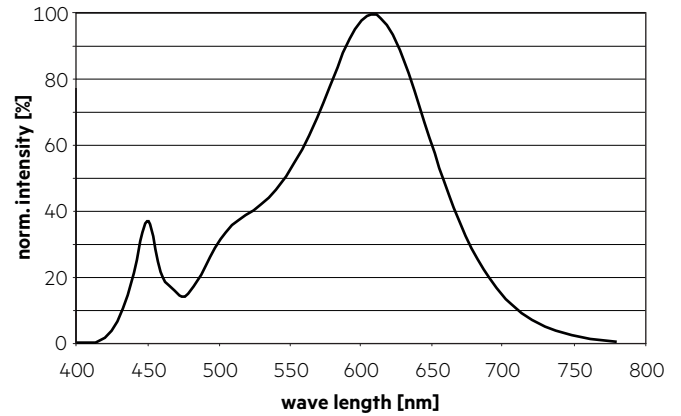
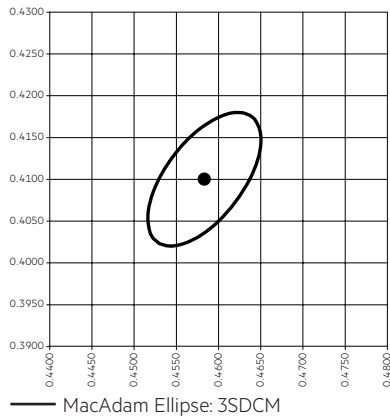

3,000 K

	x0	y0
Centre	0.4338	0.4030

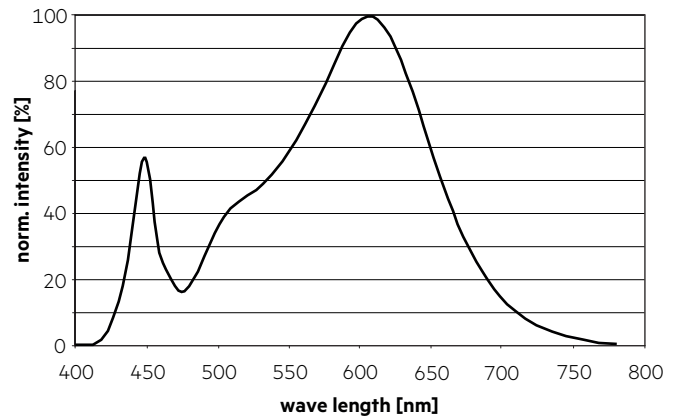
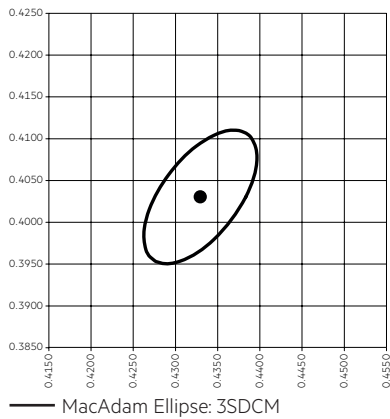

3,500 K

	x0	y0
Centre	0.4073	0.3917

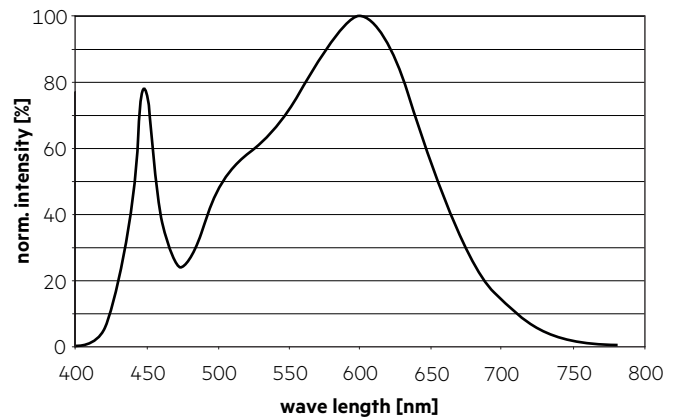
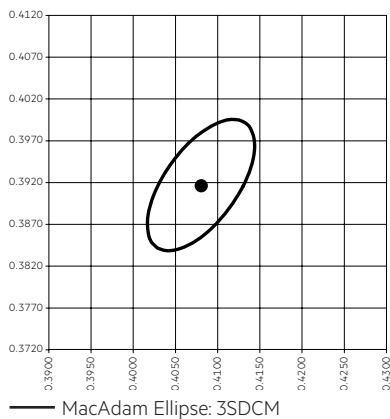

4,000 K

	x0	y0
Center	0.3818	0.3797

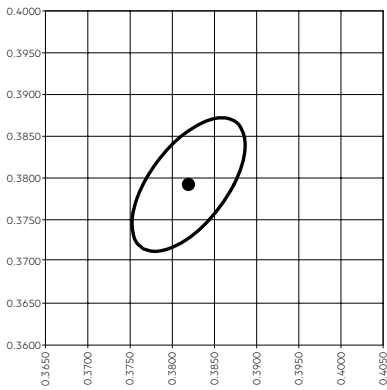

— MacAdam Ellipse: 3SDCM

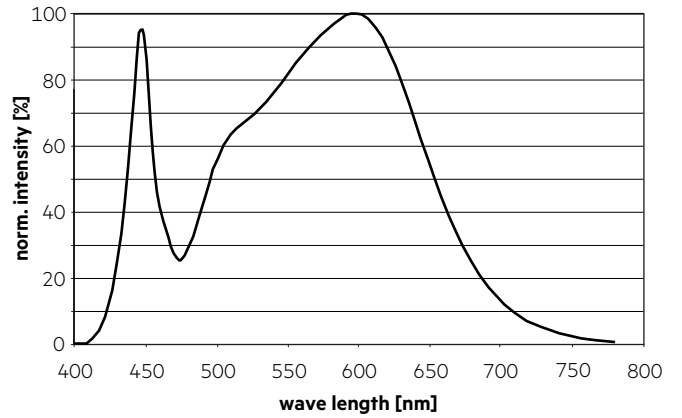

5,000 K

	x0	y0
Center	0.3447	0.3553

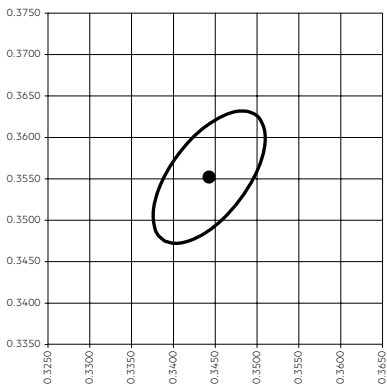

— MacAdam Ellipse: 3SDCM

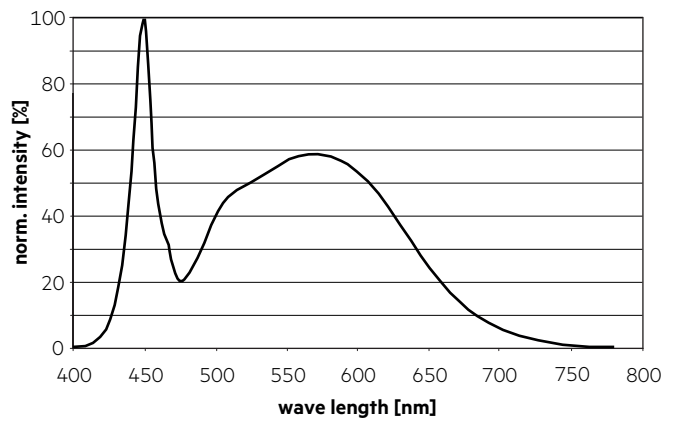

6,500 K

	x0	y0
Center	0.3123	0.3282

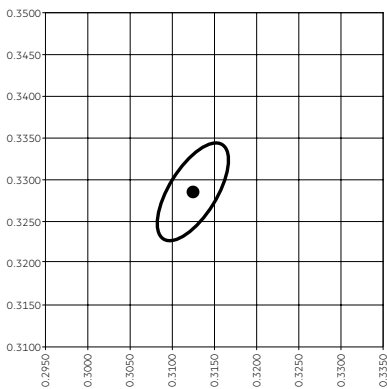

— MacAdam Ellipse: 3SDCM

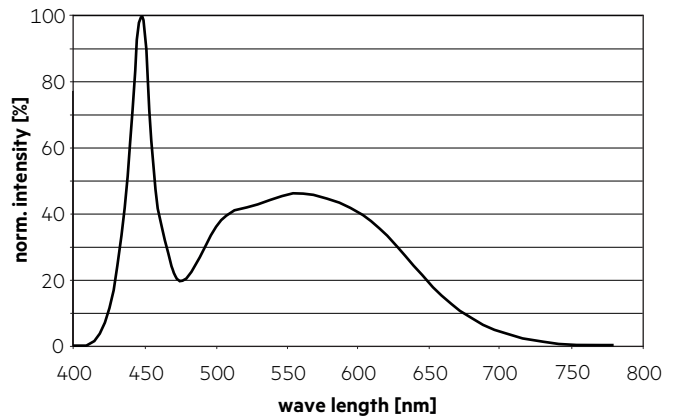

6.2 Light distribution

The optical design of the LLE product line ensures optimum homogeneity for the light distribution.

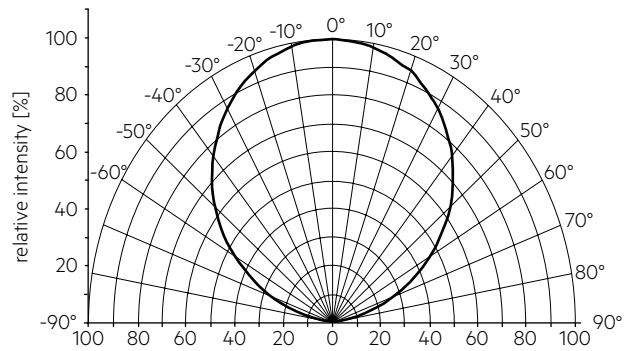

The colour temperature is measured integral over the complete module. The single LED light points can have deviations in the colour coordinates within MacAdam 5.

To ensure an ideal mixture of colours and a homogeneous light distribution a suitable optic (e. g. PMMA diffuser) and a sufficient spacing between module and optic (typ. 4 cm) should be used.

6.3 Relative luminous flux vs. tc temperature

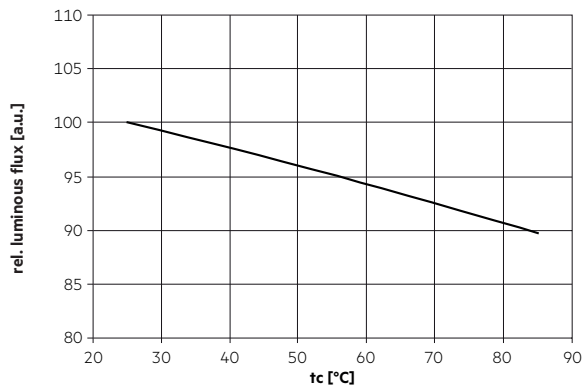

6.4 Relative luminous flux vs. operating current

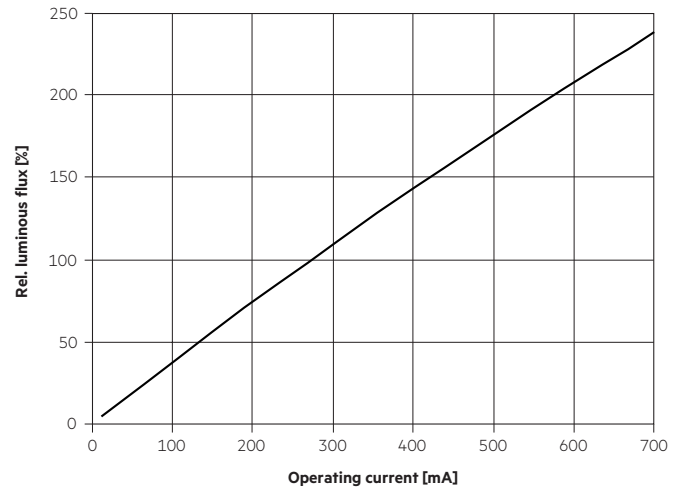

The diagrams are based on statistic values.
The real values can be different.

7. Miscellaneous

7.1 Additional information

Additional technical information at www.tridonic.com → Technical Data

Guarantee conditions at www.tridonic.com → Services

Lifetime declarations are informative and represent no warranty claim.