

Module SLE 13/17mm 927-965 PRE2

Modules SLE premium

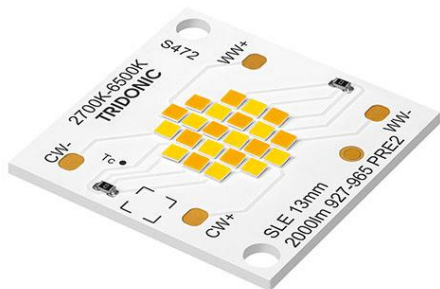

LES13

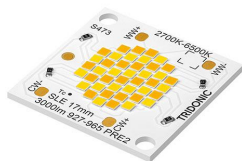

LES17

Product description

- _ For spotlights and downlights
- _ For operating with DT8 TW driver
- _ Uniform radiation with SMD technology
- _ Built-in LED module
- _ Cooling required
- _ Flexible operating mode
- _ Long lifetime: 60,000 hours
- _ 5 years guarantee (conditions at

<https://www.tridonic.com/en/int/services/manufacturer-guarantee-conditions>)

Optical properties

- _ Tunable White system for Downlights with adjustable colour temperature from 2,700 to 6,500 K at constant luminous flux
- _ Useful luminous flux 3,004 lm at Irated and tp = 25 °C
- _ Efficacy of the LED module 105 lm/W at Irated and tp = 25 °C
- _ High colour rendering index CRI > 90
- _ High colour consistency (MacAdam 3) ^①

Mechanical properties

- _ Module dimension LES13 and LES17
- _ Fixing holes for M3 screws

^① Integral measurement over the complete module.

Website

<http://www.tridonic.com/28003940>

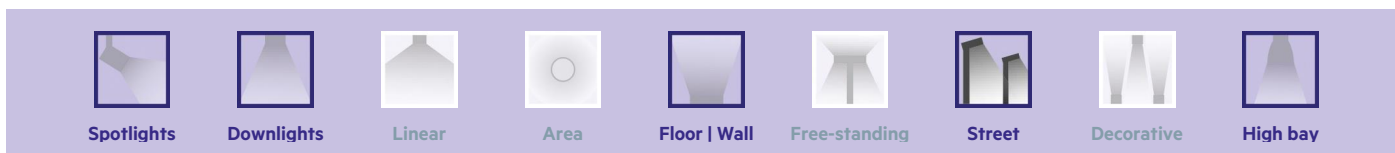
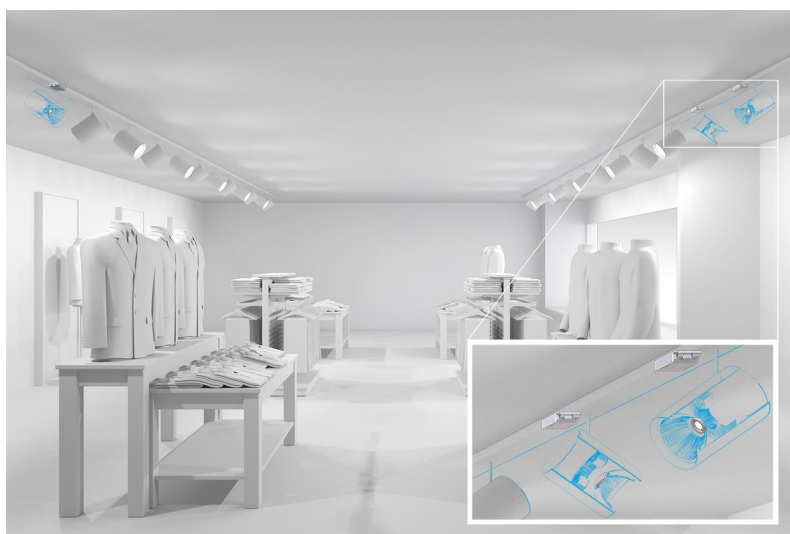

Technical data

Beam angle	120°
Ambient temperature t_a	-25 ... +55 °C
t_p rated	65 °C
t_c	100 °C
Rated for LES13	575 mA
Rated for LES17	865 mA
I_{max} for LES13 ^②	600 mA
I_{max} for LES17 ^②	950 mA
Max. permissible LF current ripple for LES13	660 mA
Max. permissible LF current ripple for LES17	1,050 mA
Max. permissible peak current for LES13	1,000 mA / max. 8 ms
Max. permissible peak current for LES17	1,400 mA / max. 8 ms
Max. working voltage for insulation SELV	< 60 V
Insulation test voltage	0.5 kV
CTI of the printed circuit board	≥ 600
Colour tolerance	3 SDCM
ESD classification	Severity level 2
Risk group (EN 62471:2008) for LES13	RG2 (Eth _r = 819 lx, RG1 at d ≥ 289 mm)
Risk group (IEC 62471) for LES17	RG2 (Eth _r = 845 lx, RG1 at d ≥ 289 mm)
Type of protection	IP00
Lumen maintenance L70B50	60,000 h
Guarantee (conditions at www.tridonic.com)	5 Year(s)

Approval marks**Standards**

EN 62031, EN 62471, IEC 62717, IEC 61000-4-2

Specific technical data

Type	Channel	Photometric code	Useful luminous flux at $t_p = 25\text{ °C}$ ^③	Expected luminous flux at t_p rated ^④	Typ. forward current	Min. forward voltage at t_p rated	Max. forward voltage at $t_p = 25\text{ °C}$	Power consumption P_{on} at $t_p = 25\text{ °C}$ ^⑤	Efficacy of the module at $t_p = 25\text{ °C}$	Expected efficacy of the module at t_p rated	Colour rendering index: CRI
SLE 13mm 2000lm 927-965 PRE2	WW	927/349	1,948 lm	1,852 lm	575 mA	30.6 V	36.0 V	19.5 W	100 lm/W	98 lm/W	>90
SLE 13mm 2000lm 927-965 PRE2	CW	965/349	-	2,006 lm	575 mA	30.6 V	36.0 V	-	-	106 lm/W	>90
SLE 17mm 3000lm 927-965 PRE2	WW	927/349	3,004 lm	2,862 lm	865 mA	30.2 V	34.9 V	28.7 W	105 lm/W	102 lm/W	>90
SLE 17mm 3000lm 927-965 PRE2	CW	965/349	-	2,825 lm	865 mA	27.5 V	31.8 V	-	-	101 lm/W	>90

② Total current over both channels.

③ Tolerance of useful light flux - 0 % / + 15 %. Measurement uncertainty ± 10 %.

④ Tolerance of expected light flux - 0 % / + 15 %. Measurement uncertainty ± 10 %. Based on calculation.

⑤ Tolerance of power consumption P_{on} ± 10 %. Measurement uncertainty ± 5 %.

Housing for SLE TW

**Product description**

- _ Housing for SLE TW
- _ Housing with Snap-On feature for easy reflector mounting
- _ Push terminals for quick and simple wiring
- _ The wiring can be solid wire 0.5 mm² or stranded wire with soldered ends 0.25 mm² to 0.5 mm², stripping length 6 – 7 mm
- _ Diameter: 50 mm
- _ Material: PBT-GF FR (17)
- _ M3 screws (max. head diameter of 6 mm) in combination with locking washers, max. torque for fixing is 0.5 Nm
- _ Glow wire test with 650 °C according to EN 60838-1



Housing with LES13



Housing with LES17

Website

<http://www.tridonic.com/28003868>

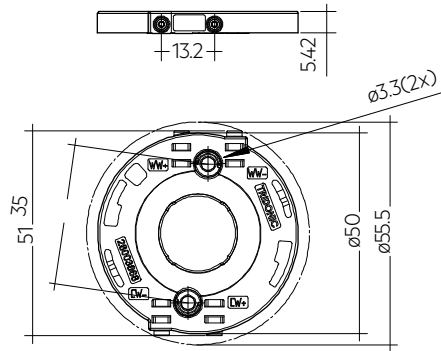

**Ordering data**

Type	Article number	Packaging, carton	Weight per pc.
SLE TW HOUSING D50 4T	28003868	42 pc(s).	0.007 kg

1. Standards

EN 62031
EN 62471
IEC 62717
IEC 61000-4-2

1.1 Photometric code

Key for photometric code, e. g. 830 / 359

1 st digit	2 nd + 3 rd digit	4 th digit	5 th digit	6 th digit	
Code	CRI	Colour temperature in Kelvin x 100	MacAdam initial	MacAdam after 25% of the lifetime (max.6000h)	
7	70 – 79			Luminous flux after 25% of the lifetime (max.6000h)	
8	80 – 89			Code	Luminous flux
9	≥90			7	≥ 70 %
				8	≥ 80 %
				9	≥ 90 %

1.2 Energy classification

Type	Colour temperature	Forward current	Energy classification	Energy consumption
SLE 13mm 2000lm 927-965 PRE2	2,700 K	575 mA	F	20 kWh / 1,000 h
SLE 17mm 3000lm 927-965 PRE2	2,700 K	865 mA	F	29 kWh / 1,000 h

Energy label and further information at www.tridonic.com in the certificates tab of the corresponding product page and at the EPREL data base <https://eprel.ec.europa.eu/>

2. Thermal details

2.1 tp point, ambient temperature and lifetime

The temperature at tp reference point is crucial for the light output and lifetime of a LED product.

For SLE PRE2 a tp temperature of 65 °C has to be complied in order to achieve an optimum between heat sink requirements, light output and lifetime.

Compliance with the maximum permissible reference temperature at the tp point must be checked under operating conditions in a thermally stable state. The maximum value must be determined under worst-case conditions for the relevant application.

The tc and tp temperature of LED modules from Tridonic are measured at the same reference point.

2.2 Storage and humidity

storage temperature	-40...+80 °C
---------------------	--------------

Operation only in non condensing environment.

Humidity during processing of the module should be between 0 to 85 %.

2.3 Derating curves

SLE G7 13mm 2000lm 927-965 PRE2

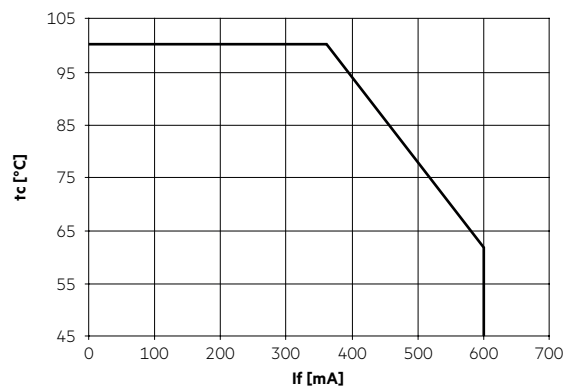

SLE G7 17mm 3000lm 927-965 PRE2

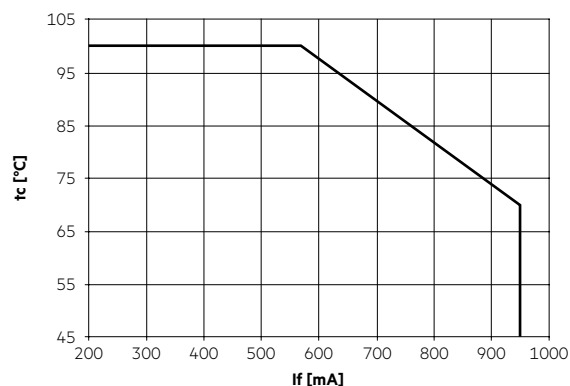

2.4 Thermal design and heat sink

The rated life of LED products depends to a large extent on the temperature. If the permissible temperature limits are exceeded, the life of the SLE PRE2 will be greatly reduced or the SLE PRE2 may be destroyed.

2.5 Heat sink values

SLE 13mm 2000lm 927-965 PRE2

ta	tp	Forward current	R _{th, hs-a}	Cooling area
25°C	65°C	575 mA	2,83 K/W	236 cm ²
35°C	65°C	575 mA	2,11 K/W	317 cm ²
40°C	65°C	575 mA	1,75 K/W	382 cm ²
45°C	65°C	575 mA	1,39 K/W	481 cm ²
50°C	65°C	575 mA	1,03 K/W	649 cm ²
55°C	65°C	575 mA	0,67 K/W	999 cm ²
60°C	65°C	575 mA	0,31 K/W	2,168 cm ²

SLE 17mm 3000lm 927-965 PRE2

ta	tp	Forward current	R _{th, hs-a}	Cooling area
25°C	65°C	865 mA	1,92 K/W	347 cm ²
35°C	65°C	865 mA	1,43 K/W	467 cm ²
40°C	65°C	865 mA	1,18 K/W	565 cm ²
45°C	65°C	865 mA	0,93 K/W	714 cm ²
50°C	65°C	865 mA	0,69 K/W	970 cm ²
55°C	65°C	865 mA	0,44 K/W	1,513 cm ²
60°C	65°C	865 mA	0,19 K/W	3,434 cm ²

Notes

The actual cooling can differ because of the material, the structural shape, outside influences and the installation situation. A thermal connection between SLE PRE2 and heat sink with heat-conducting paste or heat conducting adhesive film is absolutely necessary.

Additionally the SLE PRE2 has to be fixed on the heat sink with M3 screws to optimise the thermal connection.

Use of thermal interface material with thermal conductivity of $\lambda > 1 \text{ W/mK}$ and layer thickness of interface material with max. 50 μm or a similar interface material where the quotient of layer thickness and thermal conductivity $b < 50 \mu\text{mmK/W}$.

3. Installation / wiring

3.1 Electrical supply/choice of LED driver

SLE PRE2 from Tridonic are not protected against overvoltages, overcurrents, overloads or short-circuit currents. Safe and reliable operation can only be guaranteed in conjunction with a LED driver which complies with the relevant standards. The use of LED drivers from Tridonic in combination with SLE PRE2 guarantees the necessary protection for safe and reliable operation.

If a LED driver other than Tridonic is used, it must provide the following protection:

- Short-circuit protection
- Overload protection
- Overtemperature protection



SLE PRE2 modules must be operated with SELV LED drivers. SLE PRE2 modules are not designed for parallel or serial wiring. A separate driver or output channel (for multi-channel LED drivers) must be used for each SLE PRE2 module.



SLE PRE2 are basic insulated up to 60 V SELV against ground and can be mounted directly on earthed metal parts of the luminaire. If the max. output voltage of the LED driver (also against earth) is above 60 V SELV, an additional insulation between LED module and heat sink is required (for example by insulated thermal pads) or by a suitable luminaire construction.

At voltages > 60 V an additional protection against direct touch (test finger) to the light emitting side of the module has to be guaranteed. This is typically achieved by means of a non removable light distributor over the module.

3.2 Wiring

Module:

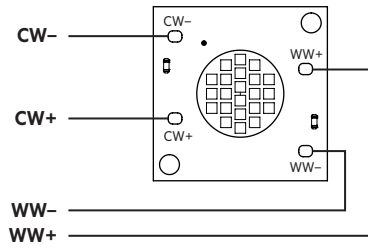

Accessory: SLE TW HOUSING D50 4T

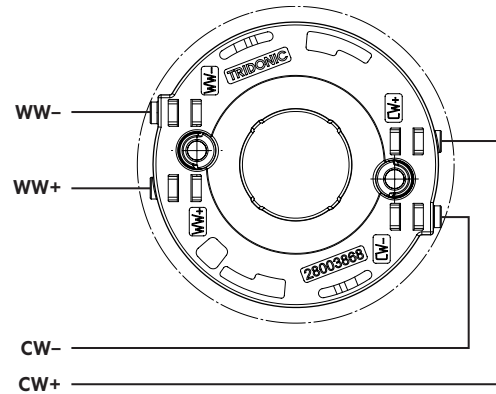

SLE PRE is connected by using SLE TW HOUSING D50 4T (accessory) or by soldering.

 The modules are suitable only for manual soldering (max. 260 °C, 2 seconds).

Wiring diagram for switchDIM and colourSWITCH for SLE premium

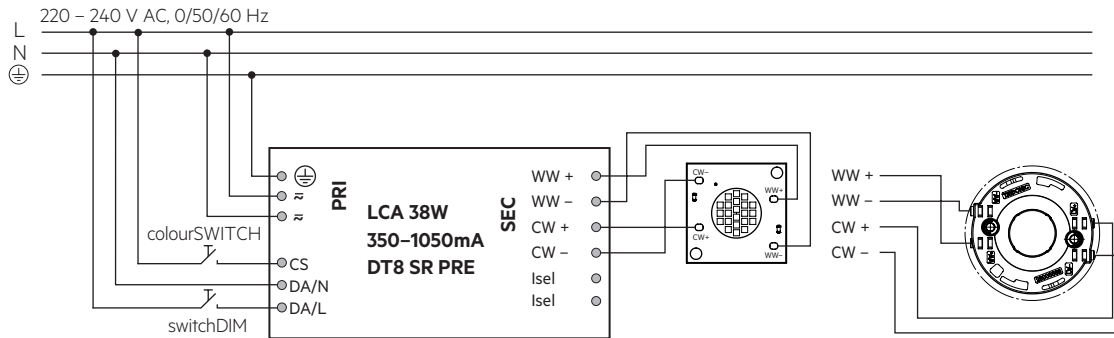

Wiring diagram for DALI for SLE premium

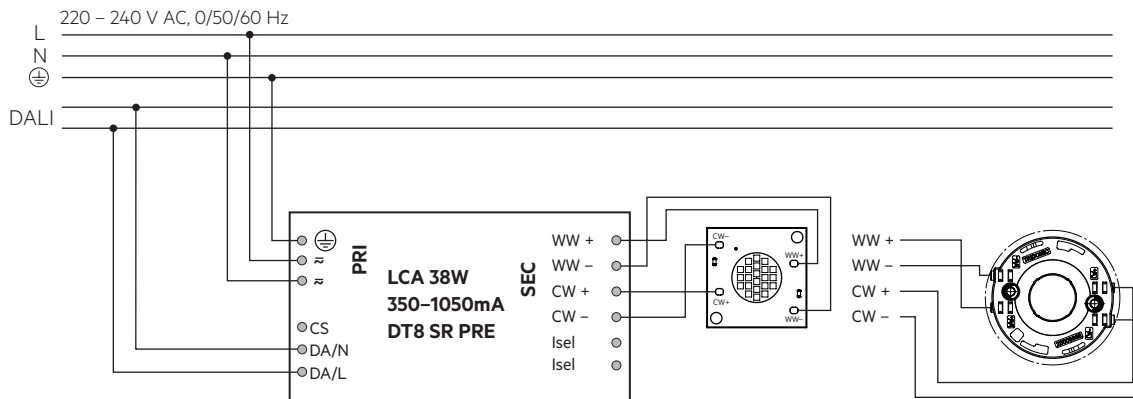

3.3 Mounting instruction



SLE PRE2 from Tridonic which have to be installed on a heat sink have to be connected with heat-conducting paste or heat conducting adhesive film and fixed with M3 screws.

The fixing/cooling surface must be cleaned by removing all dirt, dust and grease before installing the LED modules.

None of the components of the SLE PRE2 (substrate, LED, electronic components etc.) may be exposed to tensile or compressive stresses.



Max. torque for fixing: 0.5 Nm

The LED modules are mounted with 2 screws per module. In order not to damage the modules only rounded head screws and an additional plastic flat washer (notice working temperature) or rounded head screw with collar (ISO 7380-2) with head diameter ≤ 6.9 mm must be used.



Chemical substance may harm the LED module. Chemical reactions could lead to colour shift, reduced luminous flux or a total failure of the module caused by corrosion of electrical connections.

Materials which are used in LED applications (e.g. sealings, adhesives) must not produce dissolver gas. They must not be condensation curing based, acetate curing based or contain sulfur, chlorine or phthalate.

Avoid corrosive atmosphere during usage and storage.

3.4 EOS/ESD safety guidelines



The device / module contains components that are sensitive to electrostatic discharge and may only be installed in the factory and on site if appropriate EOS/ESD protection measures have been taken. No special measures need be taken for devices/modules with enclosed casings (contact with the pc board not possible), just normal installation practice.

For further information for EOS/ESD safety guidelines and the ESD classification please refer to the brochure entitled <http://www.tridonic.com/esd-protection>.

4. Lifetime

4.1 Lifetime, lumen maintenance and failure rate

The light output of an LED module decreases over the lifetime, this is characterized with the L value. L70 means that the LED module will give 70 % of its initial luminous flux. This value is always related to the number of operation hours and therefore defines the lifetime of an LED module.

As the L value is a statistical value and the lumen maintenance may vary over the delivered LED modules. The B value defines the amount of modules which are below the specific L value, e.g. L70B10 means 10 % of the LED modules are below 70 % of the initial luminous flux, respectively 90 % will be above 70 % of the initial value.

In addition the percentage of failed modules (fatal failure) is characterized by the C value.

The F value is the combination of the B and C value. That means for F degradation and complete failures are considered, e.g. L70F10 means 10 % of the LED modules may fail or be below 70 % of the initial luminous flux.

4.2 Lumen maintenance

SLE G7 13mm 2000lm 927-965 PRE2

Operating current	tp temperature	L90 / B10	L90 / B50	L80 / B10	L80 / B50	L70 / B10	L70 / B50
575 mA	45 °C	> 60k h	> 60k h	> 60k h	> 60k h	> 60k h	> 60k h
	50 °C	> 60k h	> 60k h	> 60k h	> 60k h	> 60k h	> 60k h
	55 °C	> 60k h	> 60k h	> 60k h	> 60k h	> 60k h	> 60k h
	60 °C	> 60k h	> 60k h	> 60k h	> 60k h	> 60k h	> 60k h
	65 °C	> 60k h	> 60k h	> 60k h	> 60k h	> 60k h	> 60k h

SLE G7 17mm 3000lm 927-965 PRE2

Operating current	tp temperature	L90 / B10	L90 / B50	L80 / B10	L80 / B50	L70 / B10	L70 / B50
865 mA	45 °C	> 60k h	> 60k h	> 60k h	> 60k h	> 60k h	> 60k h
	50 °C	> 60k h	> 60k h	> 60k h	> 60k h	> 60k h	> 60k h
	55 °C	> 60k h	> 60k h	> 60k h	> 60k h	> 60k h	> 60k h
	60 °C	> 60k h	> 60k h	> 60k h	> 60k h	> 60k h	> 60k h
	65 °C	> 60k h	> 60k h	> 60k h	> 60k h	> 60k h	> 60k h
	70 °C	> 60k h	> 60k h	> 60k h	> 60k h	> 60k h	> 60k h
	75 °C	> 60k h	> 60k h	> 60k h	> 60k h	> 60k h	> 60k h

L00C03 >60k h. At tp rated and I rated, based on 10 swichting cycles per day.

5. Electrical values

5.1 Declaration of electrical parameters

I_{rated} ... Nominal operating current the module is designed for.

I_{max} ... Max. permissible continuous operating current incl. The tolerances of the LED driver.

Max. permissible LF current ripple ... Max. output current of the LED driver incl. Tolerances and LF current ripple must not exceed this value.

Max. permissible peak current ... The max. output peak current of the LED driver must not exceed this value.

5.2 Typ. forward voltage vs. forward current

SLE 13mm 2000lm 927-965 PRE2

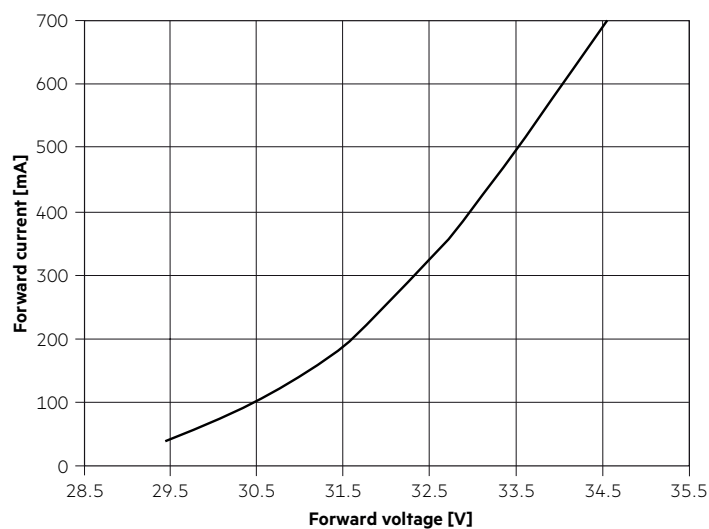

SLE 17mm 3000lm 927-965 PRE2 WW

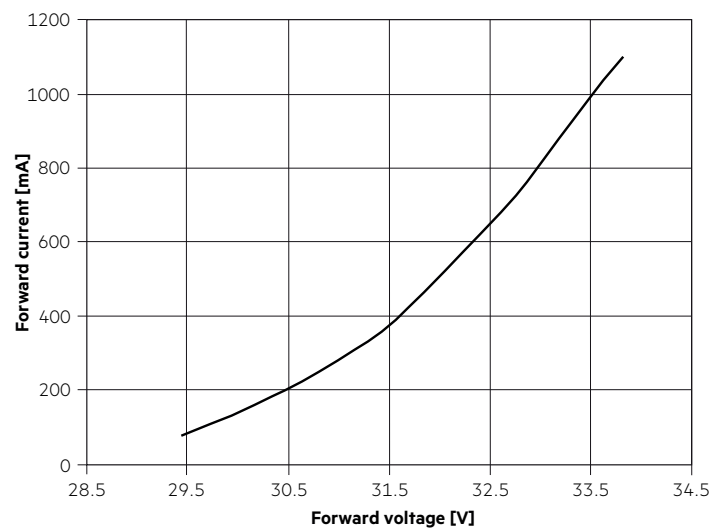

SLE 17mm 3000lm 927-965 PRE2 CW

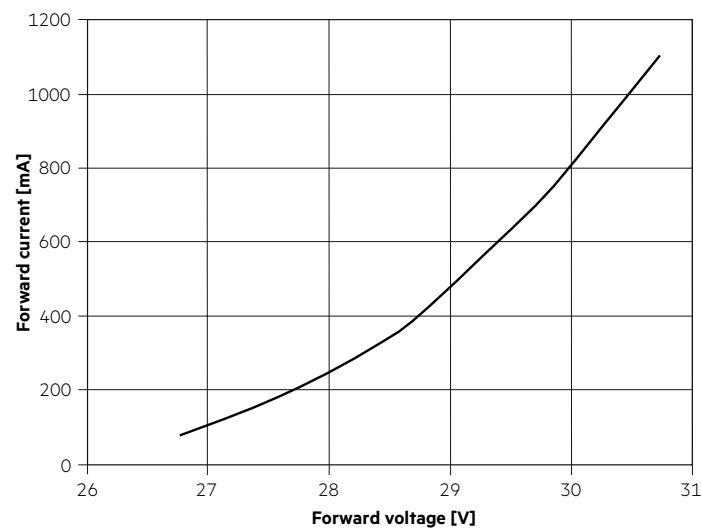

5.3 Forward voltage vs. tp temperature

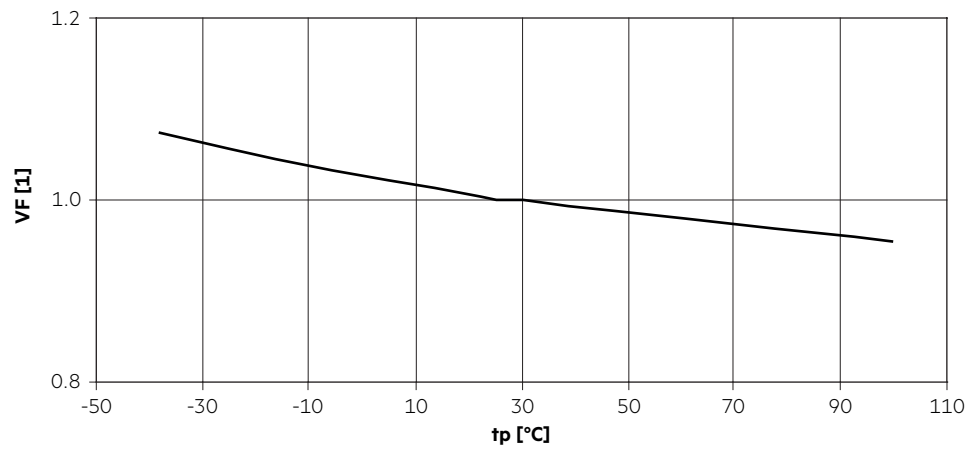

The diagrams based on statistic values.
The real values can be different.

6. Photometric characteristics

6.1 Coordinates and tolerances according to CIE 1931 and colour rendering

The specified colour coordinates are measured integral after a settling time of 100 ms. The current impuls depends on the module type. The ambient temperature of the measurement is $t_a = 25^\circ\text{C}$. The measurement tolerance of the colour coordinates are ± 0.01 .

Module type	Current impulse
SLE 13mm 2000lm 927-965 PRE2	350 mA
SLE 17mm 3000lm 927-965 PRE2	700 mA

2,700 K

	x0	y0
Centre	0.4558	0.4074

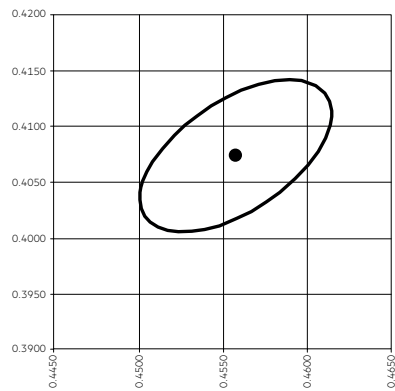

MacAdam ellipse: 3SDCM

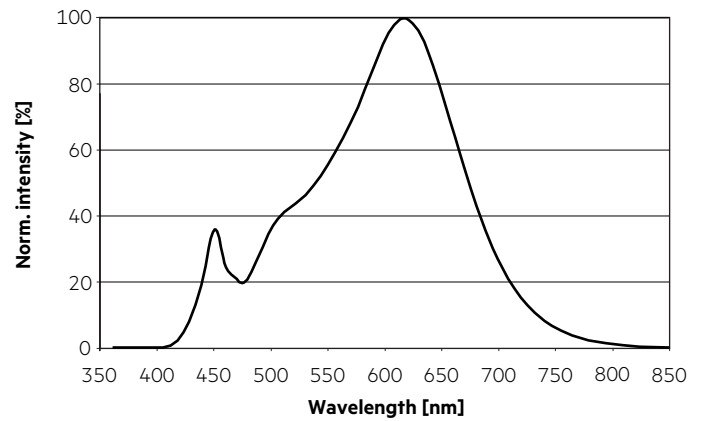

6,500 K

	x0	y0
Centre	0.3113	0.3242

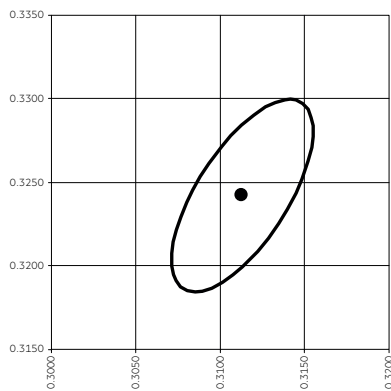

MacAdam ellipse: 3SDCM

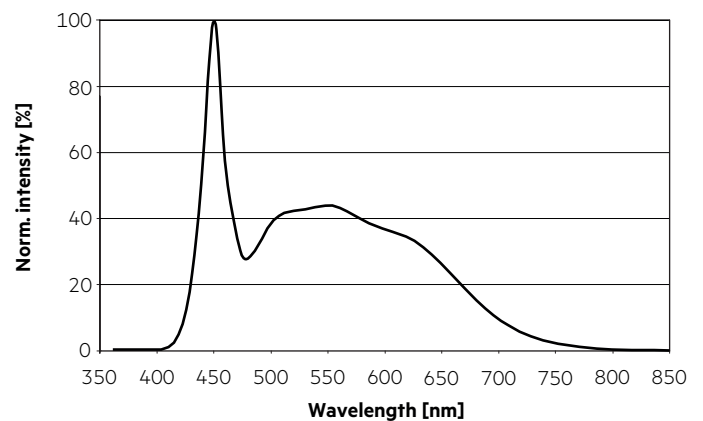

6.2 Light distribution

The optical design of the SLE product line ensures optimum homogeneity for the light distribution.

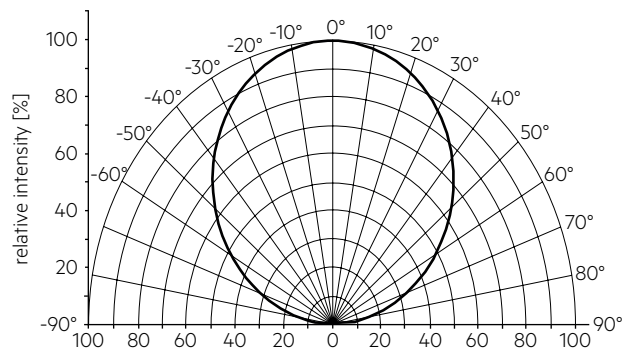

6.3 Relative luminous flux vs. tp temperature

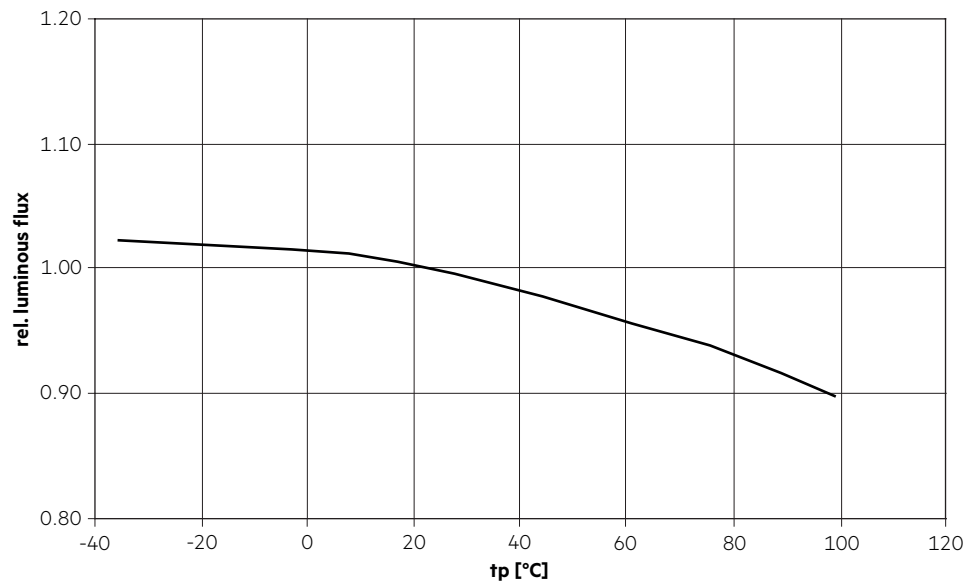

6.4 Relative luminous flux vs. operating current

SLE 13mm 2000lm 927-965 PRE2

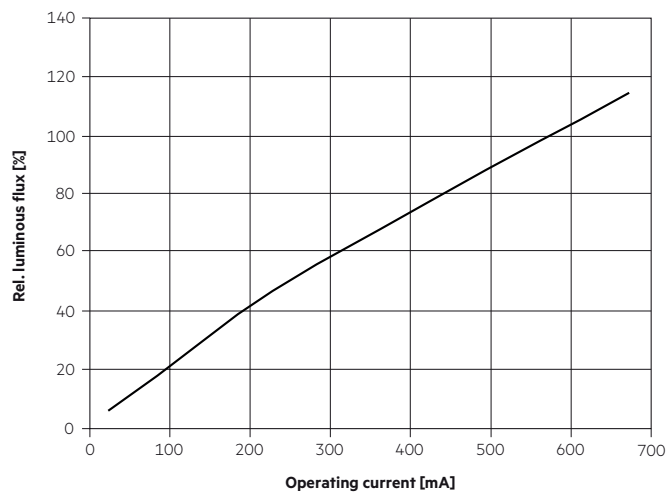

SLE 17mm 3000lm 927-965 PRE2

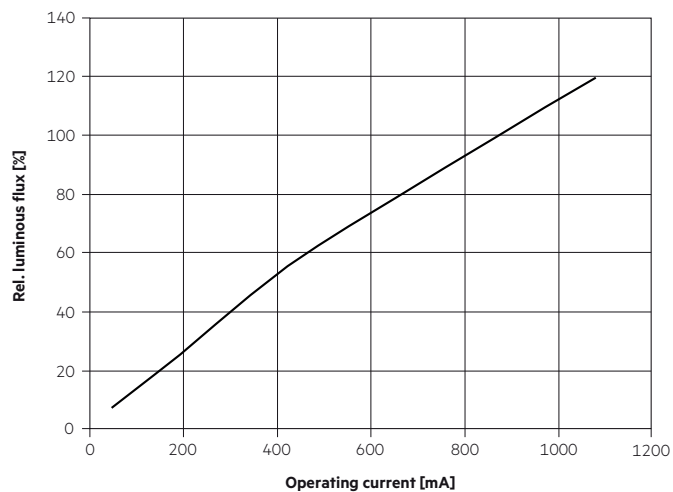

7. Miscellaneous

7.1 Additional information

Additional technical information at www.tridonic.com → Technical Data

Guarantee conditions at www.tridonic.com → Services

Lifetime declarations are informative and represent no warranty claim.

Colour rendering information are typical values and represent no warranty claim.