

Driver LC 55W 350–1050mA 54V bDW NF h16 PRE4

16 mm premium NFC series

**Product description**

- _ Can be integrated in Casambi systems (Casambi Ready)
- _ NEW: lumDATA (Luminaire data, Energy reporting and Diagnostics & Maintenance)
- _ Dimmable built-in constant current LED driver
- _ Forms automatically a wireless communication network with up to 250 nodes
- _ Dimming range 1 to 100 %
- _ For luminaires of protection class I and protection class II
- _ Output current adjustable between 350 – 1,050 mA
- _ Max. output power 55 W
- _ Up to 91.6 % efficiency
- _ Power input on stand-by < 0.26 W
- _ Nominal lifetime up to 100,000 h
- _ 5 years guarantee (conditions at <https://www.tridonic.com/en/int/services/manufacturer-guarantee-conditions>)
- _ We will provide security updates for the next five years after the date of purchase of this product
- _ The driver is a safety isolating device with SELV output

Housing properties

- _ Low profile metal casing with white cover
- _ Only 16 mm housing height
- _ Type of protection IP20

Interfaces

- _ basicDIM Wireless
- _ Near field communication (NFC)
- _ switchDIM interface for local dimming
- _ Terminal blocks: 0° push terminals

Functions

- _ Adjustable output current in 1-mA-steps (NFC)
- _ lumDATA (Luminaire data, Energy reporting and Diagnostics & Maintenance)
- _ Constant light output function (eCLO)
- _ Power-up fading at AC
- _ Switch off the driver with fade2zero
- _ Protective features (overtemperature, short-circuit, overload, no-load)
- _ Suitable for emergency escape lighting systems acc. to EN 50172

Benefits

- _ Support NFC multiple programming (full carton box)
- _ Application-oriented operating window for maximum compatibility
- _ Best energy savings due to low stand-by losses and high efficiency
- _ Reliability proven by lifetime up to 100,000 h and 5 years guarantee (conditions at <https://www.tridonic.com/en/int/services/manufacturer-guarantee-conditions>)

Typical applications

- _ For linear/area lighting in office applications

Website

<http://www.tridonic.com/28006280>



Spotlights



Downlights



Linear



Area



Floor | Wall



Free-standing



Street



Decorative



High bay

Driver LC 55W 350–1050mA 54V bDW NF h16 PRE4

16 mm premium NFC series

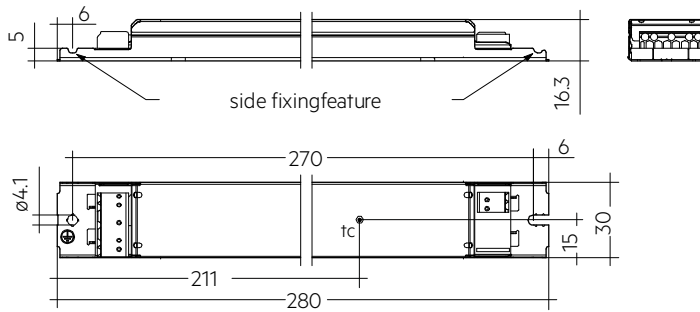
**Ordering data**

Type	Article number	Packaging, carton	Packaging, pallet	Weight per pc.
LC 55/350-1050/54 bDW NF h16 PRE4	28006280	10 pc(s).	920 pc(s).	0.166 kg

Technical data

Rated supply voltage	220 – 240 V
AC voltage range	198 – 264 V
DC voltage range	176 – 280 V
Mains frequency	0 / 50 / 60 Hz
Overvoltage protection	320 V AC, 48 h
Typ. rated current (at 230 V, 50 Hz, full load) ^{①②}	265 mA
Typ. current (220 V, 0 Hz, full load, 15 % dimming level) ^②	54 mA
Leakage current (PE)	< 300 µA
Max. input power	60.1 W
Output power range (P _{rated})	5.3 – 55 W
Typ. efficiency (at 230 V, 50 Hz, full load) ^②	91.6 %
λ (at 230 V, 50 Hz, full load) ^①	0.98
λ over full operating range (max.) ^①	0.98
λ over full operating range (min.)	0.55C
Typ. power consumption on stand-by	< 0.26 W
Typ. input current in no-load operation	24 mA
Typ. input power in no-load operation	0.41 W
In-rush current (peak / duration)	31 A / 200 µs
THD (at 230 V, 50 Hz, full load) ^①	< 6.2 %
Starting time (AC mode)	< 0.7 s
Starting time (DC mode)	< 0.3 s
Switchover time (AC/DC) ^③	< 0.1 s
Turn off time (at 230 V, 50 Hz, full load)	< 10 ms
Output current tolerance ^①	± 3 %
Max. non-repetitive output peak current	≤ output current + 40 %
Output LF current ripple (< 120 Hz)	± 0.85 %
Output P _{ST_LM} (at full load)	≤ 1
Output SVM (at full load)	≤ 0.4
Max. output voltage (U-OUT)	60 V
Dimming range	1 – 100 %
Mains surge capability (between L - N)	1 kV
Mains surge capability (between L/N - PE)	2 kV
Surge voltage at output side (against PE)	< 500 V
Type of protection	IP20
Radio transceiver operating frequencies	2.4 – 2.483 GHz
Max. output power radio transceiver (E.I. R.P.) ^④	< + 20 dBm
Radio protocol	Bluetooth 4.0 or 5.0 Low Energy (BLE)
Capable for mesh network	Up to 250 nodes / Standard networks and Long Range
Lifetime	up to 100,000 h
Guarantee (conditions at www.tridonic.com)	5 Year(s)
Dimensions L x W x H	280 x 30 x 16 mm

Approval marks



Specific technical data

Type	Output ^① current	Min. output voltage	Max. output voltage	Max. output power	Typ. power consumption (at 230 V, 50 Hz, full load)	Typ. current consumption (at 230 V, 50 Hz, full load)	t _c point max.	Ambient temperature t _a
LC 55/350-1050/54 bDW NF h16 PRE4	350 mA	15 V	54.0 V	18.9 W	22.3 W	104 mA	85 °C	-20 ... +65 °C
LC 55/350-1050/54 bDW NF h16 PRE4	400 mA	15 V	54.0 V	21.6 W	25.0 W	115 mA	86 °C	-20 ... +65 °C
LC 55/350-1050/54 bDW NF h16 PRE4	450 mA	15 V	54.0 V	24.3 W	27.8 W	127 mA	86 °C	-20 ... +65 °C
LC 55/350-1050/54 bDW NF h16 PRE4	500 mA	15 V	54.0 V	27.0 W	30.6 W	138 mA	86 °C	-20 ... +65 °C
LC 55/350-1050/54 bDW NF h16 PRE4	550 mA	15 V	54.0 V	29.7 W	33.4 W	150 mA	86 °C	-20 ... +60 °C
LC 55/350-1050/54 bDW NF h16 PRE4	600 mA	15 V	54.0 V	32.4 W	36.2 W	163 mA	86 °C	-20 ... +60 °C
LC 55/350-1050/54 bDW NF h16 PRE4	650 mA	15 V	54.0 V	35.1 W	39.0 W	175 mA	86 °C	-20 ... +60 °C
LC 55/350-1050/54 bDW NF h16 PRE4	700 mA	15 V	54.0 V	37.8 W	41.9 W	187 mA	86 °C	-20 ... +60 °C
LC 55/350-1050/54 bDW NF h16 PRE4	750 mA	15 V	54.0 V	40.5 W	44.7 W	199 mA	86 °C	-20 ... +60 °C
LC 55/350-1050/54 bDW NF h16 PRE4	800 mA	15 V	54.0 V	43.2 W	47.6 W	211 mA	86 °C	-20 ... +60 °C
LC 55/350-1050/54 bDW NF h16 PRE4	850 mA	15 V	54.0 V	45.9 W	50.4 W	224 mA	86 °C	-20 ... +55 °C
LC 55/350-1050/54 bDW NF h16 PRE4	900 mA	15 V	54.0 V	48.6 W	53.3 W	236 mA	86 °C	-20 ... +55 °C
LC 55/350-1050/54 bDW NF h16 PRE4	950 mA	15 V	54.0 V	51.3 W	56.2 W	248 mA	86 °C	-20 ... +55 °C
LC 55/350-1050/54 bDW NF h16 PRE4	1,000 mA	15 V	54.0 V	54.0 W	59.1 W	260 mA	86 °C	-20 ... +55 °C
LC 55/350-1050/54 bDW NF h16 PRE4	1,018 mA	15 V	54.0 V	55.0 W	60.1 W	265 mA	86 °C	-20 ... +55 °C
LC 55/350-1050/54 bDW NF h16 PRE4	1,050 mA	15 V	52.4 V	55.0 W	60.1 W	265 mA	86 °C	-20 ... +55 °C

① Valid at 100 % dimming level. Output current is mean value.

② Depending on the selected output current.

③ Valid for immediate change of power supply type otherwise the starting time is valid.

④ E.I.R.P.: Equivalent Isotropically Radiated Power.

⑤ The table only lists a number of possible operating points but does not cover each single point. The output current can be set within the total value range in 1-mA-steps. Output current is mean value.

1. Standards

EN 55015
 EN 61000-3-2
 EN 61000-3-3
 EN 61000-4-4
 EN 61000-4-5
 EN 61347-1
 EN 61347-2-13
 EN 62384
 EN 61547
 EN 300 330
 EN 301 489-1
 EN 300 328
 EN 301 489-17

According to EN 50172 for use in central battery systems

According to EN 60598-2-22 suitable for emergency lighting installations

2. Thermal details and lifetime

2.1 Expected lifetime

Expected lifetime							
Type	Output current	ta	45 °C	50 °C	55 °C	60 °C	65 °C
LC 55/350-1050/54 bDW NF h16 PRE4	< 350 mA	tc	67 °C	71 °C	75 °C	80 °C	85 °C
		Lifetime	> 100,000 h	> 100,000 h	> 100,000 h	86,493 h	62,879 h
	351 – 500 mA	tc	68 °C	73 °C	77 °C	82 °C	86 °C
		Lifetime	> 100,000 h	> 100,000 h	> 100,000 h	79,045 h	57,068 h
	501 – 800 mA	tc	73 °C	77 °C	82 °C	86 °C	–
		Lifetime	> 100,000 h	> 100,000 h	81,832 h	59,080 h	–
	801 – 1050 mA	tc	77 °C	82 °C	86 °C	–	–
		Lifetime	> 100,000 h	78,200 h	57,644 h	–	–

The LED driver is designed for a lifetime stated above under reference conditions and with a failure probability of less than 10 %.

The relation of tc to ta temperature depends also on the luminaire design.

If the measured tc temperature is approx. 5 K below tc max., ta temperature should be checked and eventually critical components (e.g. ELCAP) measured. Detailed information on request.

3. Installation / wiring

3.1 Circuit diagram

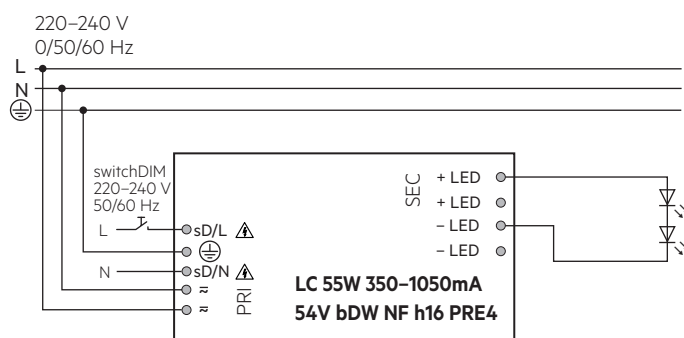

3.2 Wiring type and cross section

For wiring use solid wire from 0.5 – 1.5 mm².

Strip 8 – 9 mm of insulation from the cables to ensure perfect operation of terminals.

LED module/LED driver/supply

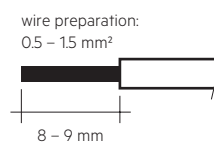

3.3 Loose wiring

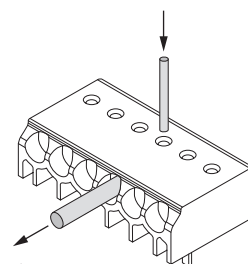

Loosen wire through twisting and pulling or using a Ø 1 mm release tool

3.4 Wiring guidelines

- Run the secondary lines separately from the mains connections and lines to achieve good EMC performance.
- The max. secondary cable length is 2 m (4 m circuit).
- For good EMC performance, keep the LED wiring as short as possible.
- Secondary switching is not permitted.
- The LED driver has no inverse-polarity protection on the secondary side. Wrong polarity can damage LED modules with no inverse-polarity protection.
- Wrong wiring of the LED driver can lead to malfunction or irreparable damage.
- To avoid damage of the Driver, the wiring must be protected against short circuits to earth (sharp edged metal parts, metal cable clips, louver, etc.).

3.5 Hot plug-in



Hot plug-in is not supported due to residual output voltage of > 0 V. When connecting an LED load, restart the device to activate the LED output. This can be done via mains reset.

3.6 Earth connection

The earth connection is conducted as protection earth (PE). The LED driver can be earthed via earth terminal or metal housing. If the LED driver will be earthed, protection earth (PE) has to be used. There is no earth connection required for the functionality of the LED driver. Earth connection is recommended to improve following behaviour.

- Electromagnetic interferences (EMI)
- LED glowing at stand-by
- Transmission of mains transients to the LED output
- Leakage current over LED module to earth on low dimming level

In general it is recommended to earth the LED driver if the LED module is mounted on earthed luminaire parts respectively heat sinks and thereby representing a high capacity against earth.

4. Electrical values

4.1 Operating window

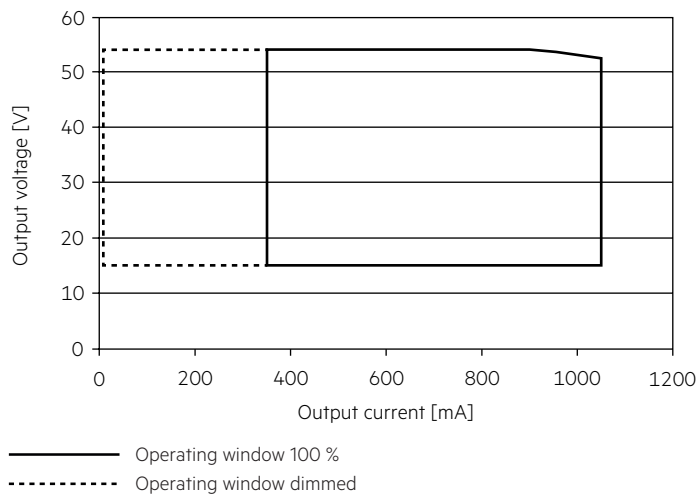

Make sure that the LED driver is operated within the given window under all operating conditions. Special attention needs to be paid at dimming and DC emergency operation as the forward voltage of the connected LED modules varies with the dimming level, due to the implemented amplitude dimming technology. Coming below the specified minimum output voltage of the LED driver may cause the device to shut-down. See chapter “6.9 DC operation” for more information.

4.2 Efficiency vs load

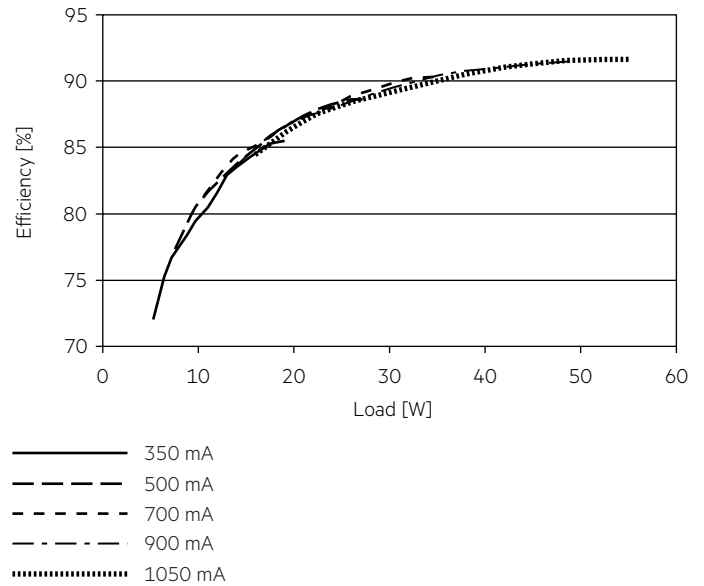

4.3 Power factor vs load

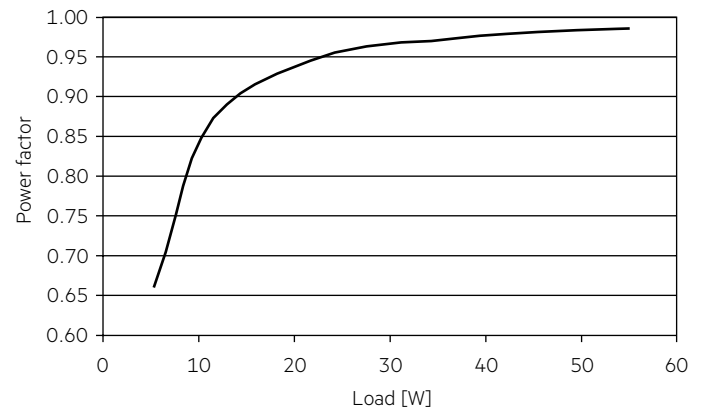

4.4 THD vs load

THD without harmonic < 5 mA (0.6 %) of the input current:

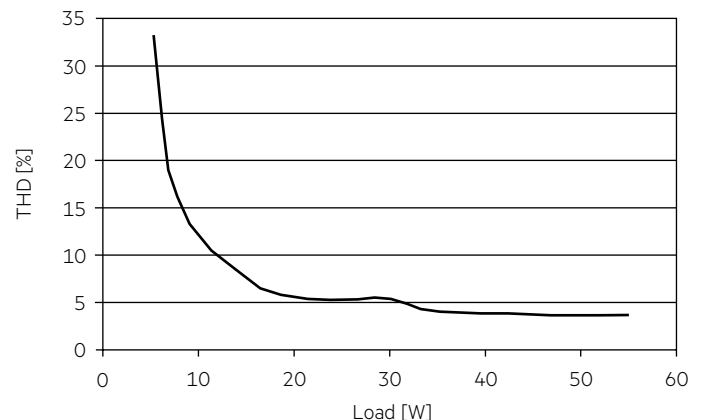

100 % load corresponds to the max. output power (full load) according to the table on page 2.

4.5 Maximum loading of automatic circuit breakers in relation to inrush current

Automatic circuit breaker type	C10	C13	C16	C20	B10	B13	B16	B20	Inrush current	
Installation \emptyset	1.5 mm ²	1.5 mm ²	2.5 mm ²	2.5 mm ²	1.5 mm ²	1.5 mm ²	2.5 mm ²	2.5 mm ²	I_{max}	time
LC 55/350-1050/54 bDW NF h16 PRE4	21	28	35	45	13	17	21	27	31 A	200 μ s

These are max. values calculated out of inrush current! Please consider not to exceed the maximum rated continuous current of the circuit breaker.

Calculation uses typical values from ABB series S200 as a reference.

Actual values may differ due to used circuit breaker types and installation environment.

4.6 Harmonic distortion in the mains supply (at 230 V / 50 Hz and full load) in %

	THD	3.	5.	7.	9.	11.
LC 55/350-1050/54 bDW NF h16 PRE4	< 6	< 4	< 1	< 1	< 2	< 1

4.7 Dimming

Dimming range 1% to 100 %

Digital control with:

- basicDIM Wireless

4.8 Dimming characteristics

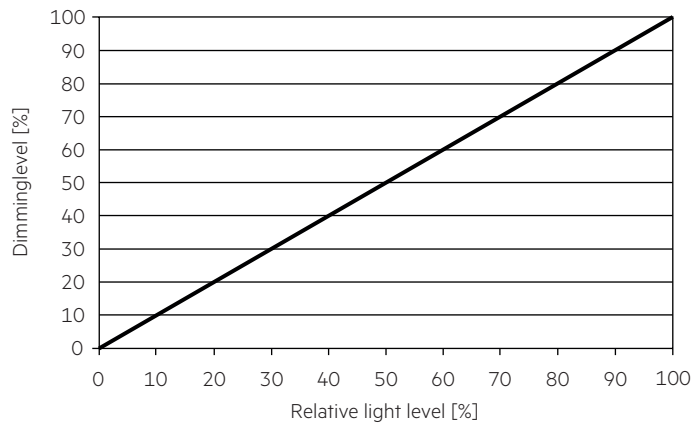

5. Software / Programming / Interfaces

5.1 Software / programming

With appropriate software and interface different functions can be activated and various parameters can be configured in the LED driver. The Driver supports the following software and interfaces:

Software for configuration:

- companionSUITE (deviceGENERATOR, deviceCONFIGURATOR, deviceANALYSER, 4service NFC app)

Interfaces for data transfer:

- NFC

5.2 Nearfield communication (NFC)

The NFC Interface allows wireless communication with the LED driver. This interface offers the option to write configuration and to read configuration, errors and events with the companionSUITE. A correct communication between the LED driver and the NFC antenna can only be guaranteed if the antenna is placed directly on the Driver. Any material placed between the LED driver and the NFC antenna can cause a deterioration of the communication quality. After programming the device via NFC power up the device one time for one second till the deviceANALYSER can read out the parameters. We recommend the use of following NFC antenna:
www.tridonic.com/nfc-readers

With a suitable NFC antenna several devices can be programmed at the same time (NFC multiprogramming).

NFC is complied with ISO/IEC 15963 standard.

Changing parameters via NFC shall be done by qualified engineers only.

5.3 Control input

switchDIM function can be connected on terminal sD/L and sD/N. This function have to be activated before using.

The control signal is not SELV. Control cable has to be installed in accordance to the requirements of low voltage installations. Different functions depending on each module. Profile change see handbook https://www.tridonic.com/com/en/download/technical/Documentation_Tridonic_4remote_BT_EN.pdf

6. Functions

6.1 Function: adjustable current

The output current of the LED driver can be adjusted in a certain range. The programming can be done by following program:

- NFC via 4-Service APP
- companionSUITE

6.2 Short-circuit behaviour

In case of a short-circuit at the LED output the LED output is switched off. After restart of the LED driver the output will be activated again. The restart can either be done via mains reset or via software or pushBUTTON.

6.3 No-load operation

The LED driver will not be damaged in no-load operation. The output will be deactivated and is therefore free of voltage. If a LED load is connected the device has to be restarted before the output will be activated again.

6.4 Overload protection

If the maximum load is exceeded by a defined internal limit, the LED driver turns off the LED output. After the restart of the LED driver, the output will be activated again. The restart can either be done via mains reset or via software or pushBUTTON.

6.5 Overtemperature protection

The LED driver is protected against temporary thermal overheating. If the temperature limit is exceeded the output current of the LED module(s) is reduced. The temperature protection is activated above $t_{c\ max}$. The activation temperature differs depending on the LED load. On DC operation this function is deactivated to fulfill emergency requirements.

6.6 OEM Identification

The OEM (Original Equipment Manufacturer) can set his own identification number.

6.7 OEM GTIN

The Original Equipment Manufacturer (OEM) can set his own Global Trade Item Number (GTIN).

6.8 Luminaire data

This function provides the asset management with accurate data about the luminaire.

6.9 Constant light output (CLO)

The luminous flux of a LED decreases constantly over the lifetime. The CLO function ensures that the emitted luminous flux remains stable. For that purpose the LED current will increase continuously over the LED lifetime. The LED driver adjusts the current afterwards automatically.

6.10 Power-up/-down fading

The power-up/-down function offers the opportunity to modify the on-/off behavior. The time for fading on or off can be adjusted in a range of 0.2 to 16 seconds. According to this value, the device dims either from 0 % up to the power-on level or from the current set dim level down to 0 %. This feature applies while operating via 4remoteBT and when switching the mains voltage on or off. By factory default no fading time is set (=0s).

6.11 fade2zero

When the Driver is switched off, fade2zero allows a smooth dimming down to almost zero.

fade2zero only works if the minimum dimming level of the Driver is the default value.

The device then dims to far below the limit of its working window (dimming range).

This function is deactivated by default.

6.12 Light level in DC operation

The LED driver is designed to operate on DC voltage and pulsed DC voltage. For a reliable operation, make sure that also in DC emergency operation the LED driver is run within the specified conditions as stated in chapter "4.1 operating window".

Light output level in DC operation: programmable 1 – 100 % (EOF_i = 0.13).

The voltage-dependent input current of Driver incl. LED module is depending on the used load.

The voltage-dependent no-load current of Driver (without or defect LED module) is for:

AC: < 12.4 mA

DC: < 4.5 mA

6.13 Software / programming

With appropriate software and an interface different functions can be activated and various parameters can be configured in the LED driver. To do so, the utilityAPP is required.

7. Miscellaneous

7.1 Insulation and electric strength testing of luminaires

Electronic devices can be damaged by high voltage. This has to be considered during the routine testing of the luminaires in production.

According to IEC 60598-1 Annex Q (informative only!) or ENEC 303-Annex A, each luminaire should be submitted to an insulation test with 500 V_{DC} for 1 second. This test voltage should be connected between the interconnected phase and neutral terminals and the earth terminal. The insulation resistance must be at least 2 MΩ.

As an alternative, IEC 60598-1 Annex Q describes a test of the electrical strength with 1500 V_{AC} (or 1.414 x 1500 V_{DC}). To avoid damage to the electronic devices this test must not be conducted.

7.2 Conditions of use and storage

Humidity: 5% up to max. 85%,
not condensed
(max. 56 days/year at 85%)

Storage temperature: -40 °C up to max. +80 °C

The devices have to be acclimatised to the specified temperature range (t_a) before they can be operated.

The LED driver is declared as inbuilt LED controlgear, meaning it is intended to be used within a luminaire enclosure.

If the product is used outside a luminaire, the installation must provide suitable protection for people and environment (e.g. in illuminated ceilings).

7.3 Placement

basicDIM Wireless has an integrated antenna for easy integration. In order to maximize the range in every direction some design guidelines should be taken into consideration when mounting the device.

The antenna is located on the corner of the enclosure. It is on the top side of the internal PCB (Printed Circuit Board).

When the device is mounted on a metal plate (e.g. frame of a luminaire), it may efficiently block the radio frequency signal. In this case, a cut-out underneath the antenna may be needed for the RF signal to exit the structure. The cut-out area should be as large as possible. Also the device should be placed as far away from any vertical metal structures as possible.

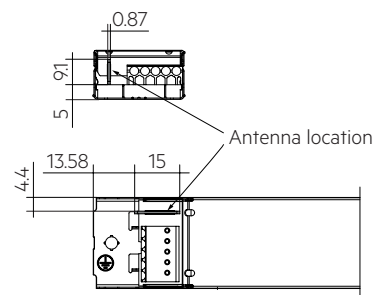

The range of the communication signal is depending on the environment e.g. luminaire, construction of the building, furnitures or humans and needs to be tested and approved in the installation.

7.4 Network compatibility

This Driver is fully compatible with networks which support up to 250 nodes (Evolution networks). If the Driver is used with different types of basicDIM Wireless devices in an Evolution network, their compatibility has to be checked before. If a device is not compatible with Evolution networks, it can be only used in networks which support up to max. of 127 devices (Classic networks).

7.5 Maximum number of switching cycles

All LED driver are tested with 50,000 switching cycles. The actually achieved number of switching cycles is significantly higher.

7.6 Additional information

Additional technical information at www.tridonic.com → Technical Data

Lifetime declarations are informative and represent no warranty claim. No warranty if device was opened.