

Module SLE ADV8 CRI90

Modules SLE advanced



LES17 with housing



LES21 with housing

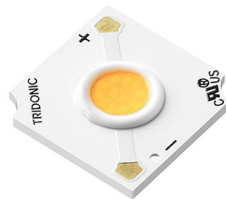

LES04

Product description

- _ For spotlights and downlights
- _ TIM variants for easy and fast assembly
- _ For operating with SELV Driver suitable
- _ Excellent thermal management by COB technology
- _ Uniform radiation with Dam&Fill technology
- _ Integrated LED module
- _ Cooling required
- _ Flexible operating mode
- _ 4,000 K CRI90 module COI approved acc. to AS/NZS1680.2.5:1997
- _ Long lifetime: 60,000 hours
- _ 5 years guarantee (conditions at <https://www.tridonic.com/en/int/services/manufacturer-guarantee-conditions>)

Optical properties

- _ Colour temperatures 2,700, 3,000, 3,500 and 4,000 K
- _ Useful luminous flux 4,816 lm at Irated and tp = 25 °C
- _ Efficacy of the LED module 159 lm/W at Irated and tp = 25 °C
- _ High colour rendering index CRI > 90
- _ Small colour tolerance (MacAdam 3) ①

Mechanical properties

- _ Module dimension LES04, LES06, LES09, LES13, LES15, LES17 and LES21
- _ Housing with Snap-On feature for easy reflector mounting
- _ 50 mm housing with 35 mm mounting hole distance acc. to Zhaga
- _ Fixing holes for M3 screws

System solution

- _ Integrate compatible partner products into your final system solution: <https://www.tridonic.com/en/int/products/accessories#partner>
- _ Combine Tridonic's LED modules and dimmable drivers to achieve an outstanding system efficacy (configuration possible via <https://setbuilder.tridonic.com/>)

① Integral measurement over the complete module.

Website

<http://www.tridonic.com/28004539>



Spotlights



Downlights



Linear



Area



Floor | Wall



Free-standing



Street



Decorative



High bay

Module SLE ADV8 CRI90

Modules SLE advanced

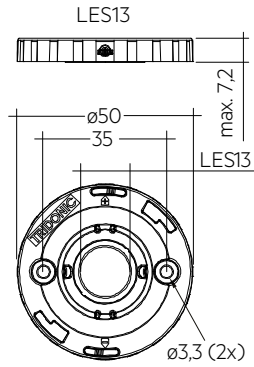

Dimensions in mm, *optical LES

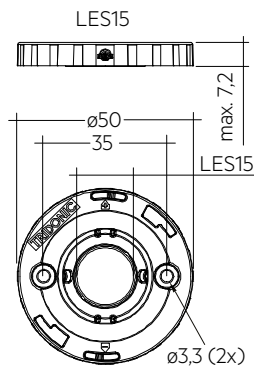

Dimensions in mm, *optical LES

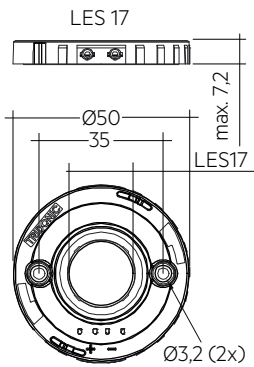

Dimensions in mm, *optical LES

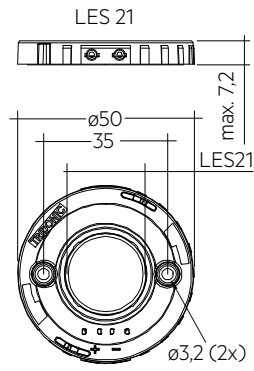

Dimensions in mm, *optical LES

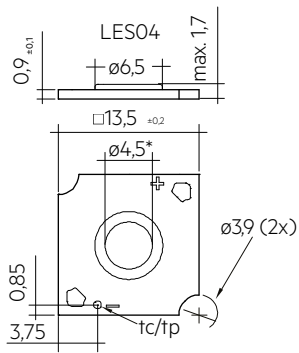

Dimensions in mm, *optical LES

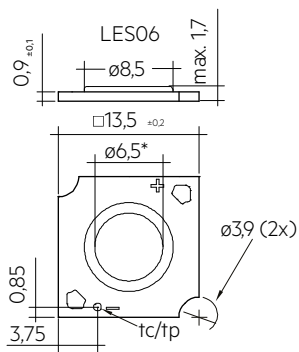

Dimensions in mm, *optical LES

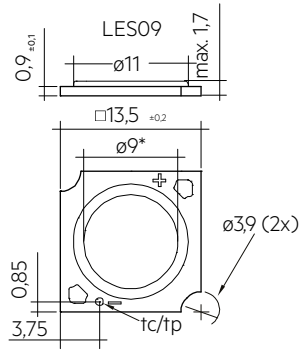

Dimensions in mm, *optical LES

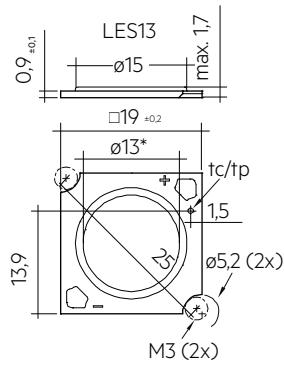

Dimensions in mm, *optical LES

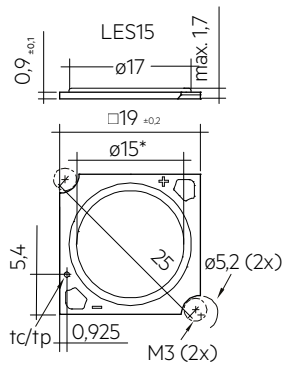

Dimensions in mm, *optical LES

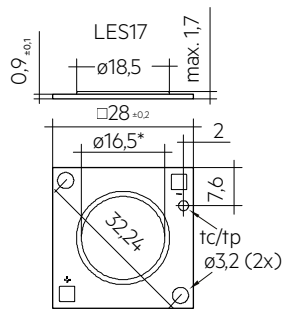

Dimensions in mm, *optical LES

Ordering data

Type	Article number	Colour temperature	Colour rendering index CRI	Packaging, carton	Weight per pc.
SLE 04mm 800lm 930 R ADV8	28004539	3,000 K	>90	20 pc(s).	0.001 kg
SLE 04mm 800lm 940 R ADV8	28004540	4,000 K	>90	20 pc(s).	0.001 kg
SLE 06mm 1600lm 930 R ADV8	28004541	3,000 K	>90	20 pc(s).	0.001 kg
SLE 06mm 1600lm 940 R ADV8	28004542	4,000 K	>90	20 pc(s).	0.001 kg
SLE 09mm 800lm 930 R ADV8	28004545	3,000 K	>90	20 pc(s).	0.001 kg
SLE 09mm 800lm 935 R ADV8	28004546	3,500 K	>90	20 pc(s).	0.001 kg
SLE 09mm 800lm 940 R ADV8	28004547	4,000 K	>90	20 pc(s).	0.001 kg
SLE 09mm 1200lm 927 R ADV8	28004551	2,700 K	>90	20 pc(s).	0.001 kg
SLE 09mm 1200lm 930 R ADV8	28004552	3,000 K	>90	20 pc(s).	0.001 kg
SLE 09mm 1200lm 940 R ADV8	28004553	4,000 K	>90	20 pc(s).	0.001 kg
SLE 09mm 2600lm 927 R ADV8	28004558	2,700 K	>90	20 pc(s).	0.001 kg
SLE 09mm 2600lm 930 R ADV8	28004559	3,000 K	>90	20 pc(s).	0.001 kg
SLE 09mm 2600lm 935 R ADV8	28004560	3,500 K	>90	20 pc(s).	0.001 kg
SLE 09mm 2600lm 940 R ADV8	28004561	4,000 K	>90	20 pc(s).	0.001 kg
SLE 13mm 3000lm 927 R ADV8	28004566	2,700 K	>90	20 pc(s).	0.001 kg
SLE 13mm 3000lm 930 R ADV8	28004567	3,000 K	>90	20 pc(s).	0.001 kg
SLE 13mm 3000lm 935 R ADV8	28004568	3,500 K	>90	20 pc(s).	0.001 kg
SLE 13mm 3000lm 940 R ADV8	28004569	4,000 K	>90	20 pc(s).	0.001 kg
SLE 13mm 3000lm 927 H ADV8	28004626	2,700 K	>90	5 pc(s).	0.001 kg
SLE 13mm 3000lm 930 H ADV8	28004572	3,000 K	>90	5 pc(s).	0.001 kg
SLE 13mm 3000lm 935 H ADV8	28004627	3,500 K	>90	5 pc(s).	0.001 kg
SLE 13mm 3000lm 940 H ADV8	28004573	4,000 K	>90	5 pc(s).	0.001 kg
SLE 15mm 4000lm 927 R ADV8	28004531	2,700 K	>90	20 pc(s).	0.001 kg
SLE 15mm 4000lm 930 R ADV8	28004532	3,000 K	>90	20 pc(s).	0.001 kg
SLE 15mm 4000lm 935 R ADV8	28004533	3,500 K	>90	20 pc(s).	0.001 kg
SLE 15mm 4000lm 940 R ADV8	28004534	4,000 K	>90	20 pc(s).	0.001 kg
SLE 15mm 4000lm 930 H ADV8	28004521	3,000 K	>90	5 pc(s).	0.001 kg
SLE 15mm 4000lm 940 H ADV8	28004522	4,000 K	>90	5 pc(s).	0.001 kg
SLE 15mm 4000lm 930 H ADV8 T	28004525	3,000 K	>90	5 pc(s).	0.001 kg
SLE 15mm 4000lm 940 H ADV8 T	28004526	4,000 K	>90	5 pc(s).	0.001 kg
SLE 17mm 5000lm 927 R ADV8	28004591	2,700 K	>90	10 pc(s).	0.002 kg
SLE 17mm 5000lm 930 R ADV8	28004592	3,000 K	>90	10 pc(s).	0.002 kg
SLE 17mm 5000lm 935 R ADV8	28004593	3,500 K	>90	10 pc(s).	0.002 kg
SLE 17mm 5000lm 940 R ADV8	28004594	4,000 K	>90	10 pc(s).	0.002 kg
SLE 17mm 5000lm 927 H ADV8	28004578	2,700 K	>90	5 pc(s).	0.002 kg
SLE 17mm 5000lm 930 H ADV8	28004579	3,000 K	>90	5 pc(s).	0.002 kg
SLE 17mm 5000lm 935 H ADV8	28004580	3,500 K	>90	5 pc(s).	0.002 kg
SLE 17mm 5000lm 940 H ADV8	28004581	4,000 K	>90	5 pc(s).	0.002 kg
SLE 17mm 5000lm 930 H ADV8 T	28004584	3,000 K	>90	5 pc(s).	0.003 kg
SLE 17mm 5000lm 935 H ADV8 T	28004585	3,500 K	>90	5 pc(s).	0.003 kg
SLE 17mm 5000lm 940 H ADV8 T	28004586	4,000 K	>90	5 pc(s).	0.003 kg
SLE 21mm 6000lm 927 R ADV8	28004612	2,700 K	>90	10 pc(s).	0.002 kg
SLE 21mm 6000lm 930 R ADV8	28004613	3,000 K	>90	10 pc(s).	0.002 kg
SLE 21mm 6000lm 935 R ADV8	28004614	3,500 K	>90	10 pc(s).	0.002 kg
SLE 21mm 6000lm 940 R ADV8	28004615	4,000 K	>90	10 pc(s).	0.002 kg
SLE 21mm 6000lm 927 H ADV8	28004598	2,700 K	>90	5 pc(s).	0.002 kg
SLE 21mm 6000lm 930 H ADV8	28004599	3,000 K	>90	5 pc(s).	0.002 kg
SLE 21mm 6000lm 935 H ADV8	28004600	3,500 K	>90	5 pc(s).	0.002 kg
SLE 21mm 6000lm 940 H ADV8	28004601	4,000 K	>90	5 pc(s).	0.002 kg
SLE 21mm 6000lm 930 H ADV8 T	28004604	3,000 K	>90	5 pc(s).	0.003 kg
SLE 21mm 6000lm 940 H ADV8 T	28004605	4,000 K	>90	5 pc(s).	0.003 kg

Technical data

Beam characteristic with housing	117°
Beam characteristic without housing	360°
Ambient temperature t_a	-30 ... +80 °C
t_p rated	65 °C
t_c	105 °C
I _{rated} for LES04	180 mA
I _{rated} for LES06	300 mA
I _{rated} for LES09 800 lm	350 mA
I _{rated} for LES09 1,200 lm	350 mA
I _{rated} for LES09 2,600 lm	600 mA
I _{rated} for LES13	500 mA
I _{rated} for LES15	800 mA
I _{rated} for LES17	900 mA
I _{rated} for LES21	1,200 mA
I _{max} for LES04	220 mA
I _{max} for LES06	440 mA
I _{max} for LES09 800 lm	500 mA
I _{max} for LES09 1,200 lm	540 mA
I _{max} for LES09 2,600 lm	880 mA
I _{max} for LES13	1,000 mA
I _{max} for LES15	1,120 mA
I _{max} for LES17	1,300 mA
I _{max} for LES21	1,960 mA
Max. perm. LF current ripple for LES04	242 mA
Max. perm. LF current ripple for LES06	484 mA
Max. perm. LF current ripple for LES09 800 lm	550 mA
Max. perm. LF current ripple for LES09 1,200 lm	594 mA
Max. perm. LF current ripple for LES09 2,600 lm	968 mA
Max. permissible LF current ripple for LES13	1,100 mA
Max. permissible LF current ripple for LES15	1,232 mA
Max. permissible LF current ripple for LES17	1,430 mA
Max. permissible LF current ripple for LES21	2,156 mA
Max. perm. peak current for LES04	260 mA / max. 8 ms
Max. perm. peak current for LES06	520 mA / max. 8 ms
Max. perm. peak current for LES09 800 lm	600 mA / max. 8 ms
Max. perm. peak current for LES09 1,200lm	640 mA / max. 8 ms
Max. perm. peak current for LES09 2,600 lm	1,050 mA / max. 8 ms
Max. permissible peak current for LES13	1,200 mA / max. 8 ms
Max. permissible peak current for LES15	1,340 mA / max. 8 ms
Max. permissible peak current for LES17	1,560 mA / max. 8 ms
Max. permissible peak current for LES21	2,350 mA / max. 8 ms
Max. working voltage for insulation SELV [®]	60 V
Insulation test voltage	0.5 kV
Colour tolerance	3 SDCM
ESD classification	Severity level 4
Risk group (IEC 62471) for LES04	RG2 (E _{thr} = 1808 lx, RG1 at d ≥ 1bd mm)
Risk group (IEC 62471) for LES06 (at I _{max})	RG2 (E _{thr} = 1808 lx, RG1 at d ≥ 610 mm)
Risk group (IEC 62471) for LES06 (at I ≤ 300 mA)	RG1
Risk group (IEC 62471) for LES09 800 lm	RG1
Risk group (IEC 62471) for LES09 1,200lm 3000K	RG1
Risk group (IEC 62471) for LES09 1,200lm 4000K (at I _{max})	RG2 (E _{thr} = 1808 lx, RG1 at d ≥ 770 mm)
Risk group (IEC 62471) for LES09 1,200lm 4000K (at I ≤ 350mA)	RG2 (E _{thr} = 1808 lx, RG1 at d ≥ 620 mm)
Risk group (IEC 62471) for LES09 2600lm 2700K (at I _{max})	RG2 (E _{thr} = 1808 lx, RG1 at d ≥ 830 mm)
Risk group (IEC 62471) for LES09 2600lm 2700K (at I ≤ 600 mA)	RG1
Risk group (IEC 62471) for LES09 2600lm 3000K (at I _{max})	RG2 (E _{thr} = 1808 lx, RG1 at d ≥ 850 mm)
Risk group (IEC 62471) for LES09 2600lm 3000K (at I ≤ 600 mA)	RG1
Risk group (IEC 62471) for LES09 2600lm 3500K (at I _{max})	RG2 (E _{thr} = 1808 lx, RG1 at d ≥ 870 mm)
Risk group (IEC 62471) for LES09 2600lm 3500K (at I ≤ 600 mA)	RG2 (E _{thr} = 1808 lx, RG1 at d ≥ 710 mm)
Risk group (IEC 62471) for LES09 2600lm 4000K (at I _{max})	RG2 (E _{thr} = 1808 lx, RG1 at d ≥ 870 mm)
Risk group (IEC 62471) for LES09 2600lm 4000K (at I ≤ 600 mA)	RG2 (E _{thr} = 1808 lx, RG1 at d ≥ 720 mm)
Risk group (EN 62471:2008) for LES13	RG1
Risk group (IEC 62471) for LES15	RG1
Risk group (IEC 62471) for LES17	RG1
Risk group (IEC 62471) for LES21	RG1
Classification acc. to IEC 62031	Built-in
Type of protection	IPO0
Lumen maintenance L70B50	60,000 h
Guarantee (conditions at www.tridonic.com)	5 Year(s)

Approval marks



Standards

EN 62031, EN 62471, IEC 62717, IEC 61000-4-2, UL 8750

Specific technical data

Type [®]	Article number	Photometric code [®]	Useful luminous flux at tp = 25 °C [®]	Expected luminous flux at tp rated [®]	Typ. forward current	Min. forward voltage at tp rated	Max. forward voltage at tp = 25 °C	Power consumption Pon at tp = 25 °C	Efficacy of the module at tp = 25 °C	Expected efficacy of the module at tp rated	Colour rendering index CRI
SLE 04mm 800lm – Operating mode HE at 150 mA											
SLE 04mm 800lm 930 R ADV8	28004539	930/359	-	642 lm	150 mA	31.5 V	37.6 V	-	-	125 lm/W	>90
SLE 04mm 800lm 940 R ADV8	28004540	940/359	-	696 lm	150 mA	31.5 V	37.6 V	-	-	136 lm/W	>90
SLE 04mm 800lm – Operating mode NM at 180 mA											
SLE 04mm 800lm 930 R ADV8	28004539	930/359	795 lm	736 lm	180 mA	32.2 V	38.5 V	6.4 W	124 lm/W	117 lm/W	>90
SLE 04mm 800lm 940 R ADV8	28004540	940/359	862 lm	799 lm	180 mA	32.2 V	38.5 V	6.4 W	135 lm/W	127 lm/W	>90
SLE 04mm 800lm – Operating mode HO at 200 mA											
SLE 04mm 800lm 930 R ADV8	28004539	930/359	-	832 lm	200 mA	32.5 V	38.7 V	-	-	118 lm/W	>90
SLE 04mm 800lm 940 R ADV8	28004540	940/359	-	894 lm	200 mA	32.5 V	38.7 V	-	-	127 lm/W	>90
SLE 06mm 1600lm – Operating mode HE at 180 mA											
SLE 06mm 1600lm 930 R ADV8	28004541	930/359	-	812 lm	180 mA	30.4 V	36.2 V	-	-	137 lm/W	>90
SLE 06mm 1600lm 940 R ADV8	28004542	940/359	-	863 lm	180 mA	30.4 V	36.2 V	-	-	145 lm/W	>90
SLE 06mm 1600lm – Operating mode NM at 300 mA											
SLE 06mm 1600lm 930 R ADV8	28004541	930/359	1,418 lm	1,320 lm	300 mA	31.7 V	37.8 V	10.5 W	136 lm/W	128 lm/W	>90
SLE 06mm 1600lm 940 R ADV8	28004542	940/359	1,464 lm	1,357 lm	300 mA	31.7 V	37.8 V	10.5 W	139 lm/W	131 lm/W	>90
SLE 06mm 1600lm – Operating mode HO at 400 mA											
SLE 06mm 1600lm 930 R ADV8	28004541	930/359	-	1,677 lm	400 mA	32.4 V	38.6 V	-	-	119 lm/W	>90
SLE 06mm 1600lm 940 R ADV8	28004542	940/359	-	1,787 lm	400 mA	32.4 V	38.6 V	-	-	127 lm/W	>90
SLE 09mm 800lm – Operating mode HE at 250 mA											
SLE 09mm 800lm 930 R ADV8	28004545	930/359	-	1,122 lm	250 mA	31.1 V	37.1 V	-	-	133 lm/W	>90
SLE 09mm 800lm 935 R ADV8	28004546	935/359	-	1,177 lm	250 mA	31.1 V	37.1 V	-	-	139 lm/W	>90
SLE 09mm 800lm 940 R ADV8	28004547	940/359	-	1,218 lm	250 mA	31.1 V	37.1 V	-	-	144 lm/W	>90
SLE 09mm 800lm – Operating mode NM at 350 mA											
SLE 09mm 800lm 930 R ADV8	28004545	930/359	1,658 lm	1,525 lm	350 mA	32.2 V	38.5 V	12.5 W	133 lm/W	124 lm/W	>90
SLE 09mm 800lm 935 R ADV8	28004546	935/359	1,688 lm	1,553 lm	350 mA	32.2 V	38.5 V	12.5 W	135 lm/W	127 lm/W	>90
SLE 09mm 800lm 940 R ADV8	28004547	940/359	1,703 lm	1,567 lm	350 mA	32.2 V	38.5 V	12.5 W	137 lm/W	128 lm/W	>90
SLE 09mm 800lm – Operating mode HO at 450 mA											
SLE 09mm 800lm 930 R ADV8	28004545	930/359	-	1,927 lm	450 mA	33.0 V	39.2 V	-	-	119 lm/W	>90
SLE 09mm 800lm 935 R ADV8	28004546	935/359	-	2,020 lm	450 mA	33.0 V	39.2 V	-	-	125 lm/W	>90
SLE 09mm 800lm 940 R ADV8	28004547	940/359	-	2,083 lm	450 mA	33.0 V	39.2 V	-	-	129 lm/W	>90
SLE 09mm 1200lm – Operating mode HE at 250 mA											
SLE 09mm 1200lm 927 R ADV8	28004551	927/359	-	1,101 lm	250 mA	30.3 V	36.0 V	-	-	134 lm/W	>90
SLE 09mm 1200lm 930 R ADV8	28004552	930/359	-	1,151 lm	250 mA	30.3 V	36.0 V	-	-	140 lm/W	>90
SLE 09mm 1200lm 940 R ADV8	28004553	940/359	-	1,219 lm	250 mA	30.3 V	36.0 V	-	-	148 lm/W	>90
SLE 09mm 1200lm – Operating mode NM at 350 mA											
SLE 09mm 1200lm 927 R ADV8	28004551	927/359	1,605 lm	1,486 lm	350 mA	30.9 V	36.8 V	11.9 W	135 lm/W	126 lm/W	>90
SLE 09mm 1200lm 930 R ADV8	28004552	930/359	1,660 lm	1,536 lm	350 mA	30.9 V	36.8 V	11.9 W	139 lm/W	131 lm/W	>90
SLE 09mm 1200lm 940 R ADV8	28004553	940/359	1,776 lm	1,644 lm	350 mA	30.9 V	36.8 V	11.9 W	149 lm/W	140 lm/W	>90
SLE 09mm 1200lm – Operating mode HO at 500 mA											
SLE 09mm 1200lm 927 R ADV8	28004551	927/359	-	2,091 lm	500 mA	31.9 V	37.9 V	-	-	121 lm/W	>90
SLE 09mm 1200lm 930 R ADV8	28004552	930/359	-	2,167 lm	500 mA	31.9 V	37.9 V	-	-	125 lm/W	>90
SLE 09mm 1200lm 940 R ADV8	28004553	940/359	-	2,304 lm	500 mA	31.9 V	37.9 V	-	-	133 lm/W	>90
SLE 09mm 2600lm – Operating mode HE at 450 mA											
SLE 09mm 2600lm 927 R ADV8	28004558	927/359	-	1,894 lm	450 mA	30.9 V	36.8 V	-	-	125 lm/W	>90
SLE 09mm 2600lm 930 R ADV8	28004559	930/359	-	2,005 lm	450 mA	30.9 V	36.8 V	-	-	133 lm/W	>90
SLE 09mm 2600lm 935 R ADV8	28004560	935/359	-	2,058 lm	450 mA	30.9 V	36.8 V	-	-	136 lm/W	>90
SLE 09mm 2600lm 940 R ADV8	28004561	940/359	-	2,114 lm	450 mA	30.9 V	36.8 V	-	-	140 lm/W	>90
SLE 09mm 2600lm – Operating mode NM at 600 mA											
SLE 09mm 2600lm 927 R ADV8	28004558	927/359	2,646 lm	2,439 lm	600 mA	31.7 V	37.8 V	21.0 W	126 lm/W	118 lm/W	>90
SLE 09mm 2600lm 930 R ADV8	28004559	930/359	2,744 lm	2,524 lm	600 mA	31.7 V	37.8 V	21.0 W	131 lm/W	122 lm/W	>90
SLE 09mm 2600lm 935 R ADV8	28004560	935/359	2,872 lm	2,642 lm	600 mA	31.7 V	37.8 V	21.0 W	137 lm/W	128 lm/W	>90
SLE 09mm 2600lm 940 R ADV8	28004561	940/359	2,899 lm	2,667 lm	600 mA	31.7 V	37.8 V	21.0 W	138 lm/W	129 lm/W	>90
SLE 09mm 2600lm – Operating mode HO at 800 mA											
SLE 09mm 2600lm 927 R ADV8	28004558	927/359	-	3,207 lm	800 mA	32.5 V	38.7 V	-	-	113 lm/W	>90
SLE 09mm 2600lm 930 R ADV8	28004559	930/359	-	3,413 lm	800 mA	32.5 V	38.7 V	-	-	121 lm/W	>90
SLE 09mm 2600lm 935 R ADV8	28004560	935/359	-	3,500 lm	800 mA	32.5 V	38.7 V	-	-	124 lm/W	>90
SLE 09mm 2600lm 940 R ADV8	28004561	940/359	-	3,598 lm	800 mA	32.5 V	38.7 V	-	-	127 lm/W	>90
SLE 13mm 3000lm – Operating mode HE at 350 mA											
SLE 13mm 3000lm 927 R ADV8	28004566	927/359	-	1,600 lm	350 mA	30.0 V	35.8 V	-	-	140 lm/W	>90
SLE 13mm 3000lm 930 R ADV8	28004567	930/359	-	1,651 lm	350 mA	30.0 V	35.8 V	-	-	144 lm/W	>90
SLE 13mm 3000lm 935 R ADV8	28004568	935/359	-	1,718 lm	350 mA	30.0 V	35.8 V	-	-	150 lm/W	>90
SLE 13mm 3000lm 940 R ADV8	28004569	940/359	-	1,767 lm	350 mA	30.0 V	35.8 V	-	-	155 lm/W	>90
SLE 13mm 3000lm 927 H ADV8	28004626	927/359	-	1,600 lm	350 mA	30.0 V	35.8 V	-	-	140 lm/W	>90
SLE 13mm 3000lm 930 H ADV8	28004572	930/359	-	1,651 lm	350 mA	30.0 V	35.8 V	-	-	144 lm/W	>90
SLE 13mm 3000lm 935 H ADV8	28004627	935/359	-	1,718 lm	350 mA	30.0 V	35.8 V	-	-	150 lm/W	>90
SLE 13mm 3000lm 940 H ADV8	28004573	940/359	-	1,767 lm	350 mA	30.0 V	35.8 V	-	-	155 lm/W	>90
SLE 13mm 3000lm – Operating mode NM at 500 mA											
SLE 13mm 3000lm 927 R ADV8	28004566	927/359	2,374 lm	2,203 lm	500 mA	30.4 V	36.2 V	16.8 W	142 lm/W	133 lm/W	>90

Type	Article number	Photometric code	Useful luminous flux at tp = 25 °C	Expected luminous flux at tp rated	Typ. forward current	Min. forward voltage at tp rated	Max. forward voltage at tp = 25 °C	Power consumption P _{on} at tp = 25 °C	Efficacy of the module at tp = 25 °C	Expected efficacy of the module at tp rated	Colour rendering index CRI
SLE 13mm 3000lm 930 R ADV8	28004567	930/359	2,471 lm	2,293 lm	500 mA	30.4 V	36.2 V	16.8 W	147 lm/W	139 lm/W	>90
SLE 13mm 3000lm 935 R ADV8	28004568	935/359	2,578 lm	2,392 lm	500 mA	30.4 V	36.2 V	16.8 W	154 lm/W	145 lm/W	>90
SLE 13mm 3000lm 940 R ADV8	28004569	940/359	2,658 lm	2,502 lm	500 mA	30.4 V	36.2 V	16.8 W	161 lm/W	151 lm/W	>90
SLE 13mm 3000lm 927 H ADV8	28004626	927/359	1,978 lm	2,203 lm	500 mA	30.4 V	36.2 V	16.8 W	142 lm/W	133 lm/W	>90
SLE 13mm 3000lm 930 H ADV8	28004572	930/359	2,058 lm	2,293 lm	500 mA	30.4 V	36.2 V	16.8 W	147 lm/W	139 lm/W	>90
SLE 13mm 3000lm 935 H ADV8	28004627	935/359	2,147 lm	2,392 lm	500 mA	30.4 V	36.2 V	16.8 W	154 lm/W	145 lm/W	>90
SLE 13mm 3000lm 940 H ADV8	28004573	940/359	2,214 lm	2,502 lm	500 mA	30.4 V	36.2 V	16.8 W	161 lm/W	151 lm/W	>90
SLE 13mm 3000lm – Operating mode HO at 900 mA											
SLE 13mm 3000lm 927 R ADV8	28004566	927/359	–	3,832 lm	900 mA	32.2 V	38.3 V	–	–	122 lm/W	>90
SLE 13mm 3000lm 930 R ADV8	28004567	930/359	–	3,944 lm	900 mA	32.2 V	38.3 V	–	–	125 lm/W	>90
SLE 13mm 3000lm 935 R ADV8	28004568	935/359	–	4,109 lm	900 mA	32.2 V	38.3 V	–	–	130 lm/W	>90
SLE 13mm 3000lm 940 R ADV8	28004569	940/359	–	4,203 lm	900 mA	32.2 V	38.3 V	–	–	133 lm/W	>90
SLE 13mm 3000lm 927 H ADV8	28004626	927/359	–	3,832 lm	900 mA	32.2 V	38.3 V	–	–	122 lm/W	>90
SLE 13mm 3000lm 930 H ADV8	28004572	930/359	–	3,944 lm	900 mA	32.2 V	38.3 V	–	–	125 lm/W	>90
SLE 13mm 3000lm 935 H ADV8	28004627	935/359	–	4,109 lm	900 mA	32.2 V	38.3 V	–	–	130 lm/W	>90
SLE 13mm 3000lm 940 H ADV8	28004573	940/359	–	4,203 lm	900 mA	32.2 V	38.3 V	–	–	133 lm/W	>90
SLE 15mm 4000lm – Operating mode HE at 400 mA											
SLE 15mm 4000lm 927 R ADV8	28004531	927/359	–	1,841 lm	400 mA	29.6 V	35.2 V	–	–	143 lm/W	>90
SLE 15mm 4000lm 930 R ADV8	28004532	930/359	–	1,888 lm	400 mA	29.6 V	35.2 V	–	–	147 lm/W	>90
SLE 15mm 4000lm 935 R ADV8	28004533	935/359	–	1,975 lm	400 mA	29.6 V	35.2 V	–	–	154 lm/W	>90
SLE 15mm 4000lm 940 R ADV8	28004534	940/359	–	2,030 lm	400 mA	29.6 V	35.2 V	–	–	158 lm/W	>90
SLE 15mm 4000lm 930 H ADV8	28004521	930/359	–	1,888 lm	400 mA	29.6 V	35.2 V	–	–	147 lm/W	>90
SLE 15mm 4000lm 940 H ADV8	28004522	940/359	–	2,030 lm	400 mA	29.6 V	35.2 V	–	–	158 lm/W	>90
SLE 15mm 4000lm 930 H ADV8 T	28004525	930/359	–	1,888 lm	400 mA	29.6 V	35.2 V	–	–	147 lm/W	>90
SLE 15mm 4000lm 940 H ADV8 T	28004526	940/359	–	2,030 lm	400 mA	29.6 V	35.2 V	–	–	158 lm/W	>90
SLE 15mm 4000lm – Operating mode NM at 800 mA											
SLE 15mm 4000lm 927 R ADV8	28004531	927/359	3,651 lm	3,378 lm	800 mA	30.8 V	36.6 V	27.1 W	135 lm/W	126 lm/W	>90
SLE 15mm 4000lm 930 R ADV8	28004532	930/359	3,784 lm	3,501 lm	800 mA	30.8 V	36.6 V	27.1 W	139 lm/W	131 lm/W	>90
SLE 15mm 4000lm 935 R ADV8	28004533	935/359	3,946 lm	3,652 lm	800 mA	30.8 V	36.6 V	27.1 W	145 lm/W	137 lm/W	>90
SLE 15mm 4000lm 940 R ADV8	28004534	940/359	4,151 lm	3,842 lm	800 mA	30.8 V	36.6 V	27.1 W	153 lm/W	144 lm/W	>90
SLE 15mm 4000lm 930 H ADV8	28004521	930/359	3,152 lm	3,501 lm	800 mA	30.8 V	36.6 V	27.1 W	139 lm/W	131 lm/W	>90
SLE 15mm 4000lm 940 H ADV8	28004522	940/359	3,458 lm	3,842 lm	800 mA	30.8 V	36.6 V	27.1 W	153 lm/W	144 lm/W	>90
SLE 15mm 4000lm 930 H ADV8 T	28004525	930/359	3,152 lm	3,501 lm	800 mA	30.8 V	36.6 V	27.1 W	139 lm/W	131 lm/W	>90
SLE 15mm 4000lm 940 H ADV8 T	28004526	940/359	3,458 lm	3,842 lm	800 mA	30.8 V	36.6 V	27.1 W	153 lm/W	144 lm/W	>90
SLE 15mm 4000lm – Operating mode HO at 1,050 mA											
SLE 15mm 4000lm 927 R ADV8	28004531	927/359	–	4,531 lm	1,050 mA	31.3 V	37.3 V	–	–	127 lm/W	>90
SLE 15mm 4000lm 930 R ADV8	28004532	930/359	–	4,655 lm	1,050 mA	31.3 V	37.3 V	–	–	130 lm/W	>90
SLE 15mm 4000lm 935 R ADV8	28004533	935/359	–	4,872 lm	1,050 mA	31.3 V	37.3 V	–	–	136 lm/W	>90
SLE 15mm 4000lm 940 R ADV8	28004534	940/359	–	5,018 lm	1,050 mA	31.3 V	37.3 V	–	–	140 lm/W	>90
SLE 15mm 4000lm 930 H ADV8	28004521	930/359	–	4,655 lm	1,050 mA	31.3 V	37.3 V	–	–	130 lm/W	>90
SLE 15mm 4000lm 940 H ADV8	28004522	940/359	–	5,018 lm	1,050 mA	31.3 V	37.3 V	–	–	140 lm/W	>90
SLE 15mm 4000lm 930 H ADV8 T	28004525	930/359	–	4,655 lm	1,050 mA	31.3 V	37.3 V	–	–	130 lm/W	>90
SLE 15mm 4000lm 940 H ADV8 T	28004526	940/359	–	5,018 lm	1,050 mA	31.3 V	37.3 V	–	–	140 lm/W	>90
SLE 17mm 5000lm – Operating mode HE at 450 mA											
SLE 17mm 5000lm 927 R ADV8	28004591	927/359	–	2,107 lm	450 mA	29.2 V	35.0 V	–	–	147 lm/W	>90
SLE 17mm 5000lm 930 R ADV8	28004592	930/359	–	2,170 lm	450 mA	29.2 V	35.0 V	–	–	152 lm/W	>90
SLE 17mm 5000lm 935 R ADV8	28004593	935/359	–	2,266 lm	450 mA	29.2 V	35.0 V	–	–	159 lm/W	>90
SLE 17mm 5000lm 940 R ADV8	28004594	940/359	–	2,330 lm	450 mA	29.2 V	35.0 V	–	–	163 lm/W	>90
SLE 17mm 5000lm 927 H ADV8	28004578	927/359	–	2,107 lm	450 mA	29.2 V	35.0 V	–	–	147 lm/W	>90
SLE 17mm 5000lm 930 H ADV8	28004579	930/359	–	2,170 lm	450 mA	29.2 V	35.0 V	–	–	152 lm/W	>90
SLE 17mm 5000lm 935 H ADV8	28004580	935/359	–	2,266 lm	450 mA	29.2 V	35.0 V	–	–	159 lm/W	>90
SLE 17mm 5000lm 940 H ADV8	28004581	940/359	–	2,330 lm	450 mA	29.2 V	35.0 V	–	–	163 lm/W	>90
SLE 17mm 5000lm 930 H ADV8 T	28004584	930/359	–	2,170 lm	450 mA	29.2 V	35.0 V	–	–	152 lm/W	>90
SLE 17mm 5000lm 935 H ADV8 T	28004585	935/359	–	2,266 lm	450 mA	29.2 V	35.0 V	–	–	159 lm/W	>90
SLE 17mm 5000lm 940 H ADV8 T	28004586	940/359	–	2,330 lm	450 mA	29.2 V	35.0 V	–	–	163 lm/W	>90
SLE 17mm 5000lm – Operating mode NM at 900 mA											
SLE 17mm 5000lm 927 R ADV8	28004591	927/359	4,301 lm	4,000 lm	900 mA	30.4 V	36.4 V	30.3 W	142 lm/W	135 lm/W	>90
SLE 17mm 5000lm 930 R ADV8	28004592	930/359	4,583 lm	4,262 lm	900 mA	30.4 V	36.4 V	30.3 W	151 lm/W	143 lm/W	>90
SLE 17mm 5000lm 935 R ADV8	28004593	935/359	4,654 lm	4,328 lm	900 mA	30.4 V	36.4 V	30.3 W	154 lm/W	146 lm/W	>90
SLE 17mm 5000lm 940 R ADV8	28004594	940/359	4,816 lm	4,478 lm	900 mA	30.4 V	36.4 V	30.3 W	159 lm/W	151 lm/W	>90
SLE 17mm 5000lm 927 H ADV8	28004578	927/359	3,538 lm	4,000 lm	900 mA	30.4 V	36.4 V	30.3 W	142 lm/W	135 lm/W	>90
SLE 17mm 5000lm 930 H ADV8	28004579	930/359	3,818 lm	4,262 lm	900 mA	30.4 V	36.4 V	30.3 W	151 lm/W	143 lm/W	>90
SLE 17mm 5000lm 935 H ADV8	28004580	935/359	3,877 lm	4,328 lm	900 mA	30.4 V	36.4 V	30.3 W	154 lm/W	146 lm/W	>90
SLE 17mm 5000lm 940 H ADV8	28004581	940/359	4,012 lm	4,478 lm	900 mA	30.4 V	36.4 V	30.3 W	159 lm/W	151 lm/W	>90
SLE 17mm 5000lm 930 H ADV8 T	28004584	930/359	3,818 lm	4,262 lm	900 mA	30.4 V	36.4 V	30.3 W	151 lm/W	143 lm/W	>90
SLE 17mm 5000lm 935 H ADV8 T	28004585	935/359	3,877 lm	4,328 lm	900 mA	30.4 V	36.4 V	30.3 W	154 lm/W	146 lm/W	>90
SLE 17mm 5000lm 940 H ADV8 T	28004586	940/359	4,012 lm	4,478 lm	900 mA	30.4 V	36.4 V	30.3 W	159 lm/W	151 lm/W	>90
SLE 17mm 5000lm – Operating mode HO at 1,200 mA											
SLE 17mm 5000lm 927 R ADV8	28004591	927/359	–	5,288 lm	1,200 mA	30.9 V	37.0 V	–	–	131 lm/W	>90

Type [®]	Article number	Photometric code ^②	Useful luminous flux at tp = 25 °C ^③	Expected luminous flux at tp rated ^④	Typ. forward current	Min. forward voltage at tp rated	Max. forward voltage at tp = 25 °C	Power consumption Pon at tp = 25 °C	Efficacy of the module at tp = 25 °C	Expected efficacy of the module at tp rated	Colour rendering index CRI
SLE 17mm 5000lm 930 R ADV8	28004592	930/359	-	5,393 lm	1,200 mA	30.9 V	37.0 V	-	-	134 lm/W	>90
SLE 17mm 5000lm 935 R ADV8	28004593	935/359	-	5,701 lm	1,200 mA	30.9 V	37.0 V	-	-	141 lm/W	>90
SLE 17mm 5000lm 940 R ADV8	28004594	940/359	-	5,862 lm	1,200 mA	30.9 V	37.0 V	-	-	145 lm/W	>90
SLE 17mm 5000lm 927 H ADV8	28004578	927/359	-	5,288 lm	1,200 mA	30.9 V	37.0 V	-	-	131 lm/W	>90
SLE 17mm 5000lm 930 H ADV8	28004579	930/359	-	5,393 lm	1,200 mA	30.9 V	37.0 V	-	-	134 lm/W	>90
SLE 17mm 5000lm 935 H ADV8	28004580	935/359	-	5,701 lm	1,200 mA	30.9 V	37.0 V	-	-	141 lm/W	>90
SLE 17mm 5000lm 940 H ADV8	28004581	940/359	-	5,862 lm	1,200 mA	30.9 V	37.0 V	-	-	145 lm/W	>90
SLE 17mm 5000lm 930 H ADV8 T	28004584	930/359	-	5,393 lm	1,200 mA	30.9 V	37.0 V	-	-	134 lm/W	>90
SLE 17mm 5000lm 935 H ADV8 T	28004585	935/359	-	5,701 lm	1,200 mA	30.9 V	37.0 V	-	-	141 lm/W	>90
SLE 17mm 5000lm 940 H ADV8 T	28004586	940/359	-	5,862 lm	1,200 mA	30.9 V	37.0 V	-	-	145 lm/W	>90
SLE 21mm 6000lm – Operating mode HE at 700 mA											
SLE 21mm 6000lm 927 R ADV8	28004612	927/359	-	3,295 lm	700 mA	29.4 V	35.3 V	-	-	147 lm/W	>90
SLE 21mm 6000lm 930 R ADV8	28004613	930/359	-	3,410 lm	700 mA	29.4 V	35.3 V	-	-	152 lm/W	>90
SLE 21mm 6000lm 935 R ADV8	28004614	935/359	-	3,580 lm	700 mA	29.4 V	35.3 V	-	-	160 lm/W	>90
SLE 21mm 6000lm 940 R ADV8	28004615	940/359	-	3,655 lm	700 mA	29.4 V	35.3 V	-	-	163 lm/W	>90
SLE 21mm 6000lm 927 H ADV8	28004598	927/359	-	3,295 lm	700 mA	29.4 V	35.3 V	-	-	147 lm/W	>90
SLE 21mm 6000lm 930 H ADV8	28004599	930/359	-	3,410 lm	700 mA	29.4 V	35.3 V	-	-	152 lm/W	>90
SLE 21mm 6000lm 935 H ADV8	28004600	935/359	-	3,580 lm	700 mA	29.4 V	35.3 V	-	-	160 lm/W	>90
SLE 21mm 6000lm 940 H ADV8	28004601	940/359	-	3,655 lm	700 mA	29.4 V	35.3 V	-	-	163 lm/W	>90
SLE 21mm 6000lm 930 H ADV8 T	28004604	930/359	-	3,410 lm	700 mA	29.4 V	35.3 V	-	-	152 lm/W	>90
SLE 21mm 6000lm 940 H ADV8 T	28004605	940/359	-	3,655 lm	700 mA	29.4 V	35.3 V	-	-	163 lm/W	>90
SLE 21mm 6000lm – Operating mode NM at 1,200 mA											
SLE 21mm 6000lm 927 R ADV8	28004612	927/359	5,833 lm	5,424 lm	1,200 mA	30.3 V	36.2 V	40.3 W	145 lm/W	137 lm/W	>90
SLE 21mm 6000lm 930 R ADV8	28004613	930/359	6,214 lm	5,776 lm	1,200 mA	30.3 V	36.2 V	40.3 W	154 lm/W	146 lm/W	>90
SLE 21mm 6000lm 935 R ADV8	28004614	935/359	6,309 lm	5,867 lm	1,200 mA	30.3 V	36.2 V	40.3 W	157 lm/W	149 lm/W	>90
SLE 21mm 6000lm 940 R ADV8	28004615	940/359	6,528 lm	6,072 lm	1,200 mA	30.3 V	36.2 V	40.3 W	162 lm/W	154 lm/W	>90
SLE 21mm 6000lm 927 H ADV8	28004598	927/359	4,833 lm	5,424 lm	1,200 mA	30.3 V	36.2 V	40.3 W	145 lm/W	137 lm/W	>90
SLE 21mm 6000lm 930 H ADV8	28004599	930/359	5,176 lm	5,779 lm	1,200 mA	30.3 V	36.2 V	40.3 W	154 lm/W	146 lm/W	>90
SLE 21mm 6000lm 935 H ADV8	28004600	935/359	5,255 lm	5,867 lm	1,200 mA	30.3 V	36.2 V	40.3 W	157 lm/W	149 lm/W	>90
SLE 21mm 6000lm 940 H ADV8	28004601	940/359	5,438 lm	6,072 lm	1,200 mA	30.3 V	36.2 V	40.3 W	162 lm/W	154 lm/W	>90
SLE 21mm 6000lm 930 H ADV8 T	28004604	930/359	5,176 lm	5,779 lm	1,200 mA	30.3 V	36.2 V	40.3 W	154 lm/W	146 lm/W	>90
SLE 21mm 6000lm 940 H ADV8 T	28004605	940/359	5,438 lm	6,072 lm	1,200 mA	30.3 V	36.2 V	40.3 W	162 lm/W	154 lm/W	>90
SLE 21mm 6000lm – Operating mode HO at 1,800 mA											
SLE 21mm 6000lm 927 R ADV8	28004612	927/359	-	7,898 lm	1,800 mA	31.1 V	37.3 V	-	-	130 lm/W	>90
SLE 21mm 6000lm 930 R ADV8	28004613	930/359	-	8,192 lm	1,800 mA	31.1 V	37.3 V	-	-	135 lm/W	>90
SLE 21mm 6000lm 935 R ADV8	28004614	935/359	-	8,667 lm	1,800 mA	31.1 V	37.3 V	-	-	142 lm/W	>90
SLE 21mm 6000lm 940 R ADV8	28004615	940/359	-	8,856 lm	1,800 mA	31.1 V	37.3 V	-	-	145 lm/W	>90
SLE 21mm 6000lm 927 H ADV8	28004598	927/359	-	7,898 lm	1,800 mA	31.1 V	37.3 V	-	-	130 lm/W	>90
SLE 21mm 6000lm 930 H ADV8	28004599	930/359	-	8,192 lm	1,800 mA	31.1 V	37.3 V	-	-	135 lm/W	>90
SLE 21mm 6000lm 935 H ADV8	28004600	935/359	-	8,667 lm	1,800 mA	31.1 V	37.3 V	-	-	142 lm/W	>90
SLE 21mm 6000lm 940 H ADV8	28004601	940/359	-	8,856 lm	1,800 mA	31.1 V	37.3 V	-	-	145 lm/W	>90
SLE 21mm 6000lm 930 H ADV8 T	28004604	930/359	-	8,192 lm	1,800 mA	31.1 V	37.3 V	-	-	135 lm/W	>90
SLE 21mm 6000lm 940 H ADV8 T	28004605	940/359	-	8,856 lm	1,800 mA	31.1 V	37.3 V	-	-	145 lm/W	>90

② If mounted with M4 screws with 7 mm head diameter.

③ HE ... High Efficiency, NM ... Nominal Mode, HO ... High Output.

④ The detailed explanation, see data sheet section 1.1.

⑤ Tolerance of useful light flux - 0 % / + 15 %. Measurement uncertainty ± 10 %.

⑥ Measurement uncertainty ± 10 %. Based on calculation.

⑦ Tolerance of power consumption Pon ± 10 %. Measurement uncertainty ± 5 %.

Housing for SLE

Accessory

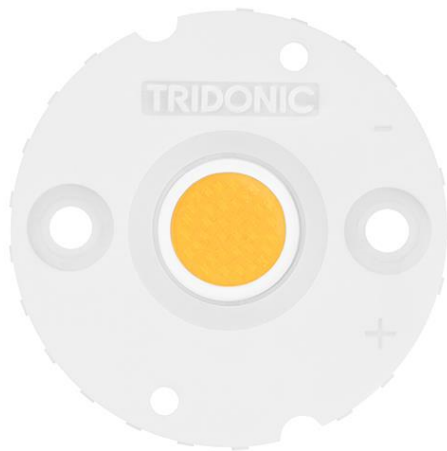

Product description

- _ Housing for SLE
- _ Diameter: 35 mm
- _ Material: Lexan Resin 943
- _ M3 screws with flat head, max. head diameter of 6 mm and max. torque for fixing is 0.5 Nm

Website

<http://www.tridonic.com/28003024>



LES09

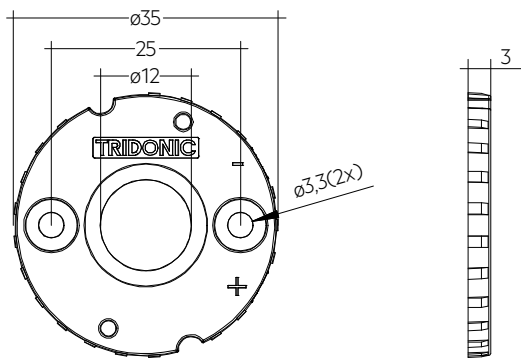

SLE G7 HOUSING LES09

Ordering data

Type	Article number	Packaging, bag	Weight per pc.
SLE G7 HOUSING LES 09	28003024	500 pc(s).	0.002 kg
SLE G7 HOUSING LES 13/15	28003026	500 pc(s).	0.002 kg

1. Standards

EN 62031
 EN 62471
 IEC 62717
 IEC 61000-4-2
 UL 8750 (for CLASS2 circuits and dry locations)

1.1 Glow wire test for housing variants

according to IEC 60695-2-11 with increased temperature of 850 °C passed.

1.2 Photometric code

Key for photometric code, e. g. 830 / 359

1 st digit	2 nd + 3 rd digit	4 th digit	5 th digit	6 th digit
Code CRI	Colour temperature in Kelvin x 100	MacAdam initial	MacAdam after 25% of the lifetime (max.6000h)	Luminous flux after 25% of the lifetime (max.6000h)
7 70 – 79				Code Luminous flux
8 80 – 89				7 ≥ 70 %
9 ≥90				8 ≥ 80 % 9 ≥ 90 %

1.3 Risk group

Type	Risk group (IEC 62471)
LES04	RG2 (E _{thr} = 1,808 lx, RG1 at d ≥ 1bd mm)
LES06 (at I _{max})	RG2 (E _{thr} = 1,808 lx, RG1 at d ≥ 610 mm)
LES06 (at I ≤ 300 mA)	RG1
LES09 800lm	RG1
LES09 1200lm 3000K	RG1
LES09 1200lm 4000K (at I _{max})	RG2 (E _{thr} = 1,808 lx, RG1 at d ≥ 770 mm)
LES09 1200lm 4000K (at I ≤ 350 mA)	RG2 (E _{thr} = 1,808 lx, RG1 at d ≥ 620 mm)
LES09 2600lm 2700K (at I _{max})	RG2 (E _{thr} = 1,808 lx, RG1 at d ≥ 830 mm)
LES09 2600lm 2700K (at I ≤ 600 mA)	RG1
LES09 2600lm 3000K (at I _{max})	RG2 (E _{thr} = 1,808 lx, RG1 at d ≥ 850 mm)
LES09 2600lm 3000K (at I ≤ 600 mA)	RG1
LES09 2600lm 3500K (at I _{max})	RG2 (E _{thr} = 1,808 lx, RG1 at d ≥ 870 mm)
LES09 2600lm 3500K (at I ≤ 600 mA)	RG2 (E _{thr} = 1,808 lx, RG1 at d ≥ 710 mm)
LES09 2600lm 4000K (at I _{max})	RG2 (E _{thr} = 1,808 lx, RG1 at d ≥ 870 mm)
LES09 2600lm 4000K (at I ≤ 600 mA)	RG2 (E _{thr} = 1,808 lx, RG1 at d ≥ 720 mm)
LES13	RG1
LES15	RG1
LES17	RG1
LES21	RG1

1.4 Energy classification

Type	Colour temperature	Forward current	Energy classification	Energy consumption
SLE 04mm – Without housing				
SLE 04mm 800lm 930 R ADV8	3,000 K	180 mA	E	7 kWh / 1,000 h
SLE 04mm 800lm 940 R ADV8	4,000 K	180 mA	E	7 kWh / 1,000 h
SLE 06mm – Without housing				
SLE 06mm 1600lm 930 R ADV8	3,000 K	300 mA	E	11 kWh / 1,000 h
SLE 06mm 1600lm 940 R ADV8	4,000 K	300 mA	E	11 kWh / 1,000 h

Type	Colour temperature	Forward current	Energy classification	Energy consumption
SLE 09mm – Without housing				
SLE 09mm 800lm 930 R ADV8	3,000 K	350 mA	E	13 kWh / 1,000 h
SLE 09mm 800lm 935 R ADV8	3,500 K	350 mA	E	13 kWh / 1,000 h
SLE 09mm 800lm 940 R ADV8	4,000 K	350 mA	E	13 kWh / 1,000 h
SLE 09mm 1200lm 927 R ADV8	2,700 K	350 mA	E	12 kWh / 1,000 h
SLE 09mm 1200lm 930 R ADV8	3,000 K	350 mA	E	12 kWh / 1,000 h
SLE 09mm 1200lm 940 R ADV8	4,000 K	350 mA	D	12 kWh / 1,000 h
SLE 09mm 2600lm 927 R ADV8	2,700 K	600 mA	E	21 kWh / 1,000 h
SLE 09mm 2600lm 930 R ADV8	3,000 K	600 mA	E	21 kWh / 1,000 h
SLE 09mm 2600lm 935 R ADV8	3,500 K	600 mA	E	21 kWh / 1,000 h
SLE 09mm 2600lm 940 R ADV8	4,000 K	600 mA	E	21 kWh / 1,000 h
SLE 13mm – Without housing				
SLE 13mm 3000lm 927 R ADV8	2,700 K	500 mA	E	17 kWh / 1,000 h
SLE 13mm 3000lm 930 R ADV8	3,000 K	500 mA	D	17 kWh / 1,000 h
SLE 13mm 3000lm 935 R ADV8	3,500 K	500 mA	D	17 kWh / 1,000 h
SLE 13mm 3000lm 940 R ADV8	4,000 K	500 mA	D	17 kWh / 1,000 h
SLE 15mm – Without housing				
SLE 15mm 4000lm 927 R ADV8	2,700 K	800 mA	E	28 kWh / 1,000 h
SLE 15mm 4000lm 930 R ADV8	3,000 K	800 mA	E	28 kWh / 1,000 h
SLE 15mm 4000lm 935 R ADV8	3,500 K	800 mA	E	28 kWh / 1,000 h
SLE 15mm 4000lm 940 R ADV8	4,000 K	800 mA	D	28 kWh / 1,000 h
SLE 17mm – Without housing				
SLE 17mm 5000lm 927 R ADV8	2,700 K	900 mA	E	31 kWh / 1,000 h
SLE 17mm 5000lm 930 R ADV8	3,000 K	900 mA	D	31 kWh / 1,000 h
SLE 17mm 5000lm 935 R ADV8	3,500 K	900 mA	D	31 kWh / 1,000 h
SLE 17mm 5000lm 940 R ADV8	4,000 K	900 mA	D	31 kWh / 1,000 h
SLE 21mm – Without housing				
SLE 21mm 6000lm 927 R ADV8	2,700 K	1,200 mA	E	41 kWh / 1,000 h
SLE 21mm 6000lm 930 R ADV8	3,000 K	1,200 mA	D	41 kWh / 1,000 h
SLE 21mm 6000lm 935 R ADV8	3,500 K	1,200 mA	D	41 kWh / 1,000 h
SLE 21mm 6000lm 940 R ADV8	4,000 K	1,200 mA	D	41 kWh / 1,000 h
SLE 13mm – With housing				
SLE 13mm 3000lm 927 H ADV8	2,700 K	500 mA	E	17 kWh / 1,000 h
SLE 13mm 3000lm 930 H ADV8	3,000 K	500 mA	E	17 kWh / 1,000 h
SLE 13mm 3000lm 935 H ADV8	3,500 K	500 mA	D	17 kWh / 1,000 h
SLE 13mm 3000lm 940 H ADV8	4,000 K	500 mA	D	17 kWh / 1,000 h
SLE 15mm – With housing				
SLE 15mm 4000lm 930 H ADV8	3,000 K	800 mA	E	28 kWh / 1,000 h
SLE 15mm 4000lm 940 H ADV8	4,000 K	800 mA	D	28 kWh / 1,000 h
SLE 15mm 4000lm 930 H ADV8 T	3,000 K	800 mA	E	28 kWh / 1,000 h
SLE 15mm 4000lm 940 H ADV8 T	4,000 K	800 mA	D	28 kWh / 1,000 h
SLE 17mm – With housing				
SLE 17mm 5000lm 927 H ADV8	2,700 K	900 mA	D	31 kWh / 1,000 h
SLE 17mm 5000lm 930 H ADV8	3,000 K	900 mA	D	31 kWh / 1,000 h
SLE 17mm 5000lm 935 H ADV8	3,500 K	900 mA	D	31 kWh / 1,000 h
SLE 17mm 5000lm 940 H ADV8	4,000 K	900 mA	D	31 kWh / 1,000 h
SLE 17mm 5000lm 930 H ADV8 T	3,000 K	900 mA	D	31 kWh / 1,000 h
SLE 17mm 5000lm 935 H ADV8 T	3,500 K	900 mA	D	31 kWh / 1,000 h
SLE 17mm 5000lm 940 H ADV8 T	4,000 K	900 mA	D	38 kWh / 1,000 h
SLE 21mm – With housing				
SLE 21mm 6000lm 927 H ADV8	2,700 K	1,200 mA	E	41 kWh / 1,000 h
SLE 21mm 6000lm 930 H ADV8	3,000 K	1,200 mA	D	41 kWh / 1,000 h
SLE 21mm 6000lm 935 H ADV8	3,500 K	1,200 mA	D	41 kWh / 1,000 h
SLE 21mm 6000lm 940 H ADV8	4,000 K	1,200 mA	D	41 kWh / 1,000 h
SLE 21mm 6000lm 930 H ADV8 T	3,000 K	1,200 mA	D	41 kWh / 1,000 h
SLE 21mm 6000lm 940 H ADV8 T	4,000 K	1,200 mA	D	41 kWh / 1,000 h

2. Thermal details

2.1 tp point, ambient temperature and lifetime

The temperature at tp reference point is crucial for the light output and lifetime of a LED product.

For SLE a tp temperature of 65 °C has to be complied in order to achieve an optimum between heat sink requirements, light output and lifetime.

Compliance with the maximum permissible reference temperature at the tp point must be checked under operating conditions in a thermally stable state. The maximum value must be determined under worst-case conditions for the relevant application.

The tc and tp temperature of LED modules from Tridonic are measured at the same reference point.

To check the tc / tp temperature, the temperature sensor has to be mounted on the PCB at the marked position as stated in the drawing.

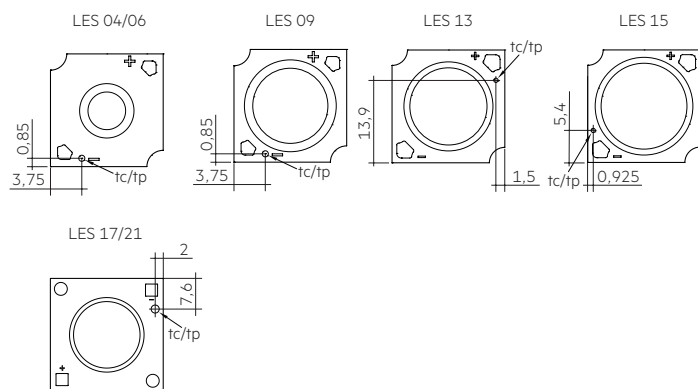

2.2 Storage and humidity

storage temperature	-30...+80 °C
---------------------	--------------

Operation only in non condensing environment.
Humidity during processing of the module should be between 0 to 85 %.

2.3 Thermal design and heat sink

The rated life of LED products depends to a large extent on the temperature. If the permissible temperature limits are exceeded, the life of the SLE will be greatly reduced or the SLE may be destroyed.

2.4 Heat sink values

SLE 04mm 800lm xxx ADV8

ta	tp	Operating current	R _{th, hs-a}
25 °C	65 °C	150 mA	2.2 K/W
35 °C	65 °C	150 mA	1.7 K/W
45 °C	65 °C	150 mA	1.1 K/W
25 °C	65 °C	180 mA	1.5 K/W
35 °C	65 °C	180 mA	1.1 K/W
45 °C	65 °C	180 mA	0.8 K/W
25 °C	65 °C	200 mA	1.1 K/W
35 °C	65 °C	200 mA	0.9 K/W
45 °C	65 °C	200 mA	0.6 K/W

SLE 06mm 1600lm xxx ADV8

ta	tp	Operating current	R _{th, hs-a}
25 °C	65 °C	150 mA	2.2 K/W
35 °C	65 °C	150 mA	1.7 K/W
45 °C	65 °C	150 mA	1.1 K/W
25 °C	65 °C	180 mA	1.5 K/W
35 °C	65 °C	180 mA	1.1 K/W
45 °C	65 °C	180 mA	0.8 K/W
25 °C	65 °C	200 mA	1.1 K/W
35 °C	65 °C	200 mA	0.9 K/W
45 °C	65 °C	200 mA	0.6 K/W

SLE 09mm 800lm xxx ADV8

ta	tp	Operating current	R _{th, hs-a}
25 °C	65 °C	250 mA	4.8 K/W
35 °C	65 °C	250 mA	3.6 K/W
45 °C	65 °C	250 mA	2.4 K/W
25 °C	65 °C	350 mA	3.1 K/W
35 °C	65 °C	350 mA	2.3 K/W
45 °C	65 °C	350 mA	1.5 K/W
25 °C	65 °C	450 mA	2.3 K/W
35 °C	65 °C	450 mA	1.7 K/W
45 °C	65 °C	450 mA	1.1 K/W

SLE 09mm 1200lm xxx ADV8

ta	tp	Operating current	R _{th, hs-a}
25 °C	65 °C	250 mA	4.6 K/W
35 °C	65 °C	250 mA	3.4 K/W
45 °C	65 °C	250 mA	2.2 K/W
25 °C	65 °C	350 mA	3.1 K/W
35 °C	65 °C	350 mA	2.3 K/W
45 °C	65 °C	350 mA	1.5 K/W
25 °C	65 °C	500 mA	2.1 K/W
35 °C	65 °C	500 mA	1.6 K/W
45 °C	65 °C	500 mA	1.0 K/W

SLE 09mm 2600lm xxx ADV8

ta	tp	Operating current	R _{th, hs-a}
25 °C	65 °C	450 mA	2.2 K/W
35 °C	65 °C	450 mA	1.7 K/W
45 °C	65 °C	450 mA	1.1 K/W
25 °C	65 °C	600 mA	1.5 K/W
35 °C	65 °C	600 mA	1.1 K/W
45 °C	65 °C	600 mA	0.8 K/W
25 °C	65 °C	800 mA	1.1 K/W
35 °C	65 °C	800 mA	0.9 K/W
45 °C	65 °C	800 mA	0.6 K/W

SLE 13mm 3000lm xxx ADV8

ta	tp	Operating current	R _{th, hs-a}
25 °C	65 °C	350 mA	3.4 K/W
35 °C	65 °C	350 mA	2.6 K/W
45 °C	65 °C	350 mA	1.7 K/W
25 °C	65 °C	500 mA	2.3 K/W
35 °C	65 °C	500 mA	1.7 K/W
45 °C	65 °C	500 mA	1.2 K/W
25 °C	65 °C	900 mA	1.2 K/W
35 °C	65 °C	900 mA	0.9 K/W
45 °C	65 °C	900 mA	0.6 K/W

SLE 15mm 4000lm xxx ADV8

ta	tp	Operating current	R _{th, hs-a}
25 °C	65 °C	400 mA	2.4 K/W
35 °C	65 °C	400 mA	1.8 K/W
45 °C	65 °C	400 mA	1.2 K/W
25 °C	65 °C	800 mA	1.3 K/W
35 °C	65 °C	800 mA	1.0 K/W
45 °C	65 °C	800 mA	0.6 K/W
25 °C	65 °C	1,050 mA	0.9 K/W
35 °C	65 °C	1,050 mA	0.7 K/W
45 °C	65 °C	1,050 mA	0.5 K/W

SLE 17mm 5000lm xxx ADV8

ta	tp	Operating current	R _{th, hs-a}
25 °C	65 °C	450 mA	2.3 K/W
35 °C	65 °C	450 mA	1.7 K/W
45 °C	65 °C	450 mA	1.1 K/W
25 °C	65 °C	900 mA	1.0 K/W
35 °C	65 °C	900 mA	0.7 K/W
45 °C	65 °C	900 mA	0.4 K/W
25 °C	65 °C	1,200 mA	0.7 K/W
35 °C	65 °C	1,200 mA	0.5 K/W
45 °C	65 °C	1,200 mA	0.3 K/W

SLE 21mm 6000lm xxx ADV8

ta	tp	Operating current	R _{th, hs-a}
25 °C	65 °C	700 mA	1.6 K/W
35 °C	65 °C	700 mA	1.2 K/W
45 °C	65 °C	700 mA	0.8 K/W
25 °C	65 °C	1,200 mA	0.7 K/W
35 °C	65 °C	1,200 mA	0.5 K/W
45 °C	65 °C	1,200 mA	0.3 K/W
25 °C	65 °C	1,800 mA	0.5 K/W
35 °C	65 °C	1,800 mA	0.3 K/W
45 °C	65 °C	1,800 mA	0.2 K/W

Notes

The actual cooling can differ because of the material, the structural shape, outside influences and the installation situation. A thermal connection between SLE and heat sink with heat-conducting paste or heat conducting adhesive film is absolutely necessary.

Additionally the SLE has to be fixed on the heat sink with M3 screws to optimise the thermal connection.

Use of thermal interface material with thermal conductivity of $\lambda > 1$ W/mK and layer thickness of interface material with max. 50 μ m or a similar interface material where the quotient of layer thickness and thermal conductivity $b < 50$ μ mK/W.

The SLE H ADV8 T modules will be delivered with thermal interface foil of type GRAFTECH HT-1205A.

The bottom side of the thermal pad is glued to the module, the upper side is not adhesive. This makes it easier to position the module when it is connected to the heat sink.



The thermal pad is an integral part of the LED module and must not be confused with a protective foil. The thermal pad must not be pulled off!

For further information about the thermal interface foil please refer to the data sheet of the product GRAFTECH HT-1205A.

3. Installation / wiring

3.1 Electrical supply/choice of LED driver

SLE from Tridonic are not protected against overvoltages, overcurrents, overloads or short-circuit currents. Safe and reliable operation can only be guaranteed in conjunction with a LED driver which complies with the relevant standards. The use of LED drivers from Tridonic in combination with SLE guarantees the necessary protection for safe and reliable operation.

If a LED driver other than Tridonic is used, it must provide the following protection:

- Short-circuit protection
- Overload protection
- Overtemperature protection



SLE must be supplied by a constant current LED driver. Operation with a constant voltage LED driver will lead to an irreversible damage of the module. Wrong polarity can damage the SLE.



SLE must not be operated with nonSELV LED driver.



SLE are basic insulated up to 60 V SELV against ground and can be mounted directly on earthed metal parts of the luminaire. If the max. output voltage of the LED driver (also against earth) is above 60 V SELV, an additional insulation between LED module and heat sink is required (for example by insulated thermal pads) or by a suitable luminaire construction.

At voltages > 60 V an additional protection against direct touch (test finger) to the light emitting side of the module has to be guaranteed. This is typically achieved by means of a non removable light distributor over the module.

3.2 Wiring

Wiring with housing (LES13 and LES15)

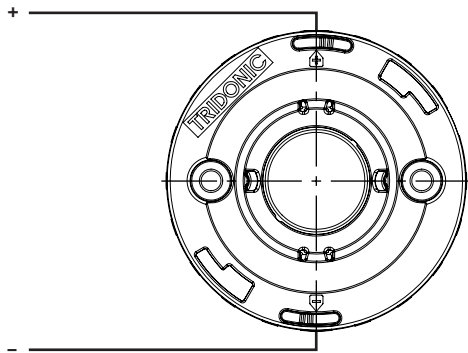

Wiring with housing (LES17 and LES21)

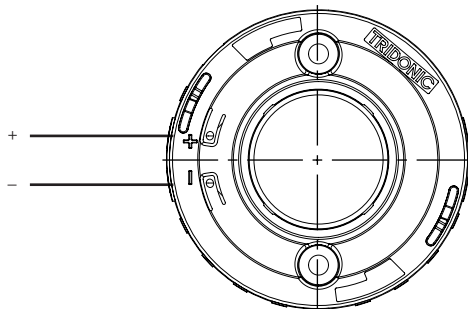

Wiring without housing

LES04 + LES06 + LES09 + LES13 + LES15

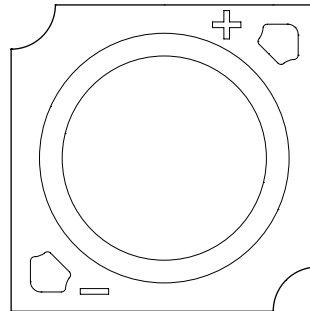

LES17 + LES21

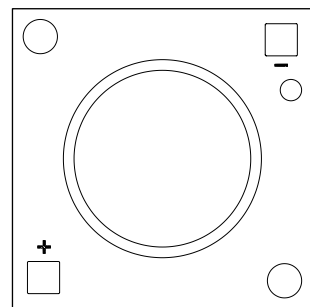

Wiring example

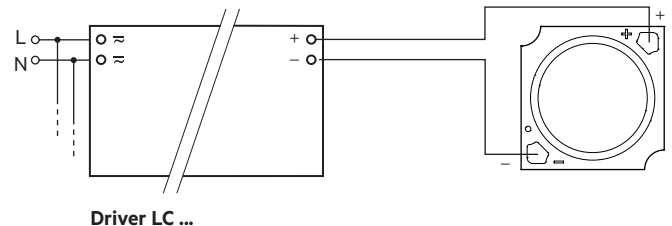

3.3 Wiring type and cross section for housing variants

For wiring use solid wire from 0.5 to 0.75 mm² or stranded wire with soldered ends of 0.5 mm².

For the push-wire connection you have to strip the insulation (6 – 7 mm).

Loosen wire through twisting and pulling.

wire preparation:

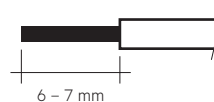

3.4 Mounting instruction



SLE from Tridonic which have to be installed on a heat sink have to be connected with heat-conducting paste or heat conducting adhesive film and fixed with M3 screws.

The fixing/cooling surface must be cleaned by removing all dirt, dust and grease before installing the LED modules.

None of the components of the SLE (substrate, LED, electronic components etc.) may be exposed to tensile or compressive stresses.



Max. torque for fixing: 0,3 Nm (LES9, LES13, LES15)
0,5 Nm (LES17, LES21)

The LED modules are mounted with 2 screws per module. In order not to damage the modules only rounded head screws and an additional plastic flat washer (notice working temperature) or rounded head screw with collar (ISO 7380-2) with head diameter \leq 6,9 mm must be used for LED modules without housing (for LES13, LES15).

Chemical substance may harm the LED module. Chemical reactions could lead to colour shift, reduced luminous flux or a total failure of the module caused by corrosion of electrical connections.



Materials which are used in LED applications (e.g. sealings, adhesives) must not produce dissolver gas. They must not be condensation curing based, acetate curing based or contain sulfur, chlorine or phthalate.

Avoid corrosive atmosphere during usage and storage.

3.5 EOS/ESD safety guidelines



The device / module contains components that are sensitive to electrostatic discharge and may only be installed in the factory and on site if appropriate EOS/ESD protection measures have been taken. No special measures need be taken for devices/modules with enclosed casings (contact with the pc board not possible), just normal installation practice.

For further information for EOS/ESD safety guidelines and the ESD classification please refer to the brochure entitled <http://www.tridonic.com/esd-protection>.

4. Lifetime

4.1 Lifetime, lumen maintenance and failure rate

The light output of an LED module decreases over the lifetime, this is characterized with the L value. L70 means that the LED module will give 70 % of its initial luminous flux. This value is always related to the number of operation hours and therefore defines the lifetime of an LED module.

As the L value is a statistical value and the lumen maintenance may vary over the delivered LED modules. The B value defines the amount of modules which are below the specific L value, e.g. L70B10 means 10 % of the LED modules are below 70 % of the initial luminous flux, respectively 90 % will be above 70 % of the initial value.

In addition the percentage of failed modules (fatal failure) is characterized by the C value.

The F value is the combination of the B and C value. That means for F degradation and complete failures are considered, e.g. L70F10 means 10 % of the LED modules may fail or be below 70 % of the initial luminous flux.

4.2 Lumen maintenance

Lifetime declarations are informative and represent no warranty claim. Preliminary calculated lifetime data until LM80 test reports are available

SLE 04mm 800lm ADV8

Operating current	tp temperature	L90 / F10	L90 / F50	L80 / F10	L80 / F50	L70 / F10	L70 / F50
150 mA	65 °C	57k h	>60k h	>60k h	>60k h	>60k h	>60k h
	85 °C	57k h	>60k h	>60k h	>60k h	>60k h	>60k h
	105 °C	9k h	14k h	20k h	31k h	33k h	50k h
180 mA	65 °C	>60k h	>60k h	>60k h	>60k h	>60k h	>60k h
	85 °C	36k h	38k h	>60k h	>60k h	>60k h	>60k h
200 mA	65 °C	>60k h	>60k h	>60k h	>60k h	>60k h	>60k h
	85 °C	36k h	38k h	>60k h	>60k h	>60k h	>60k h

SLE 06mm 1600lm ADV8

Operating current	tp temperature	L90 / F10	L90 / F50	L80 / F10	L80 / F50	L70 / F10	L70 / F50
180 mA	65 °C	>60k h	>60k h	>60k h	>60k h	>60k h	>60k h
	85 °C	57k h	>60k h	>60k h	>60k h	>60k h	>60k h
	105 °C	18k h	22k h	41k h	51k h	>60k h	>60k h
300 mA	65 °C	>57k h	>60k h	>60k h	>60k h	>60k h	>60k h
	85 °C	57k h	>60k h	>60k h	>60k h	>60k h	>60k h
	105 °C	9k h	14k h	>20k h	31k h	33k h	50k h
400 mA	65 °C	>60k h	>60k h	>60k h	>60k h	>60k h	>60k h
	85 °C	36k h	38k h	>60k h	>60k h	>60k h	>60k h

SLE 09mm 800lm ADV8

Operating current	tp temperature	L90 / F10	L90 / F50	L80 / F10	L80 / F50	L70 / F10	L70 / F50
250 mA	65 °C	57k h	>60k h	>60k h	>60k h	>60k h	>60k h
	85 °C	57k h	>60k h	>60k h	>60k h	>60k h	>60k h
	105 °C	9k h	14k h	20k h	31k h	20k h	33k h
350 mA	65 °C	>60k h	>60k h	>60k h	>60k h	>60k h	>60k h
	85 °C	36k h	>38k h	>60k h	>60k h	>60k h	>60k h
450 mA	65 °C	>60k h	>60k h	>60k h	>60k h	>60k h	>60k h
	85 °C	36k h	38k h	>60k h	>60k h	>60k h	>60k h

SLE 09mm 1200lm ADV8

Operating current	tp temperature	L90 / F10	L90 / F50	L80 / F10	L80 / F50	L70 / F10	L70 / F50
250 mA	65 °C	>60k h	>60k h	>60k h	>60k h	>60k h	>60k h
	85 °C	57k h	>60k h	>60k h	>60k h	>60k h	>60k h
	105 °C	18k h	22k h	10k h	51k h	>60k h	>60k h
350 mA	65 °C	>60k h	>60k h	>60k h	>60k h	>60k h	>60k h
	85 °C	57k h	>60k h	>60k h	>60k h	>60k h	>60k h
	105 °C	18k h	>22k h	41k h	51k h	>60k h	>60k h
500 mA	65 °C	57k h	>60k h	>60k h	>60k h	>60k h	>60k h
	85 °C	57k h	>60k h	>60k h	>60k h	>60k h	>60k h
	105 °C	9k h	14k h	20k h	31k h	33k h	50k h

SLE 09mm 2600lm ADV8

Operating current	tp temperature	L90 / F10	L90 / F50	L80 / F10	L80 / F50	L70 / F10	L70 / F50
450 mA	65 °C	>60k h	>60k h	>60k h	>60k h	>60k h	>60k h
	85 °C	57k h	>60k h	>60k h	>60k h	>60k h	>60k h
	105 °C	18k h	22k h	41k h	51k h	>60k h	>60k h
600 mA	65 °C	57k h	>60k h	>60k h	>60k h	>60k h	>60k h
	85 °C	57k h	>60k h	>60k h	>60k h	>60k h	>60k h
	105 °C	9k h	14k h	20k h	31k h	33k h	50k h
800 mA	65 °C	>60k h	>60k h	>60k h	>60k h	>60k h	>60k h
	85 °C	36k h	38k h	>60k h	>60k h	>60k h	>60k h

SLE 13mm 3000lm ADV8

Operating current	tp temperature	L90 / F10	L90 / F50	L80 / F10	L80 / F50	L70 / F10	L70 / F50
350 mA	65 °C	>60k h	>60k h	>60k h	>60k h	>60k h	>60k h
	85 °C	57k h	>60k h	>60k h	>60k h	>60k h	>60k h
	105 °C	18k h	22k h	41k h	51k h	>60k h	>60k h
500 mA	65 °C	>60k h	>60k h	>60k h	>60k h	>60k h	>60k h
	85 °C	57k h	>60k h	>60k h	>60k h	>60k h	>60k h
	105 °C	18k h	22k h	41k h	51k h	33k h	50k h
900 mA	65 °C	>60k h	>60k h	>60k h	>60k h	>60k h	>60k h
	85 °C	36k h	38k h	>60k h	>60k h	>60k h	>60k h

SLE 15mm 4000lm ADV8

Operating current	tp temperature	L90 / F10	L90 / F50	L80 / F10	L80 / F50	L70 / F10	L70 / F50
400 mA	65 °C	>60k h	>60k h	>60k h	>60k h	>60k h	>60k h
	85 °C	57k h	>60k h	>60k h	>60k h	>60k h	>60k h
	105 °C	18k h	22k h	41k h	51k h	>60 kh	>60k h
800 mA	65 °C	>60k h	>60k h	>60k h	>60k h	>60k h	>60k h
	85 °C	57k h	>60k h	>60k h	>60k h	>60k h	>60k h
	105 °C	18k h	22k h	41k h	51k h	>60 kh	50k h
1,050 mA	65 °C	57k h	>60k h	>60k h	>60k h	>60k h	>60k h
	85 °C	57k h	>60k h	>60k h	>60k h	>60k h	>60k h
	105 °C	9k h	14k h	20k h	31k h	33k h	50k h

SLE 17mm 5000lm ADV8

Operating current	tp temperature	L90 / F10	L90 / F50	L80 / F10	L80 / F50	L70 / F10	L70 / F50
450 mA	65 °C	>60k h	>60k h	>60k h	>60k h	>60k h	>60k h
	85 °C	57k h	>60k h	>60k h	>60k h	>60k h	>60k h
	105 °C	18k h	22k h	41k h	51k h	>60k h	>60k h
900 mA	65 °C	>60k h	>60k h	>60k h	>60k h	>60k h	>60k h
	85 °C	57k h	>60k h	>60k h	>60k h	>60k h	>60k h
	105 °C	18k h	22k h	41k h	51k h	>60k h	50k h
1,200 mA	65 °C	57k h	>60k h	>60k h	>60k h	>60k h	>60k h
	85 °C	57k h	>60k h	>60k h	>60k h	>60k h	>60k h
	105 °C	9k h	14k h	20k h	31k h	33k h	50k h

SLE 21mm 6000lm ADV8

Operating current	tp temperature	L90 / F10	L90 / F50	L80 / F10	L80 / F50	L70 / F10	L70 / F50
450 mA	65 °C	>60k h	>60k h	>60k h	>60k h	>60k h	>60k h
	85 °C	57k h	>60k h	>60k h	>60k h	>60k h	>60k h
	105 °C	18k h	22k h	41k h	51k h	>60k h	>60k h
900 mA	65 °C	>60k h	>60k h	>60k h	>60k h	>60k h	>60k h
	85 °C	57k h	>60k h	>60k h	>60k h	>60k h	>60k h
	105 °C	18k h	22k h	41k h	51k h	>60k h	50k h
1,200 mA	65 °C	57k h	>60k h	>60k h	>60k h	>60k h	>60k h
	85 °C	57k h	>60k h	>60k h	>60k h	>60k h	>60k h
	105 °C	9k h	14k h	20k h	31k h	33k h	50k h

5. Electrical values

5.1 Declaration of electrical parameters

Irated ... Nominal operating current the module is designed for.

I_{max} ... Max. permissible continuous operating current incl. The tolerances of the LED driver.

Max. permissible LF current ripple ... Max. output current of the LED driver incl. Tolerances and LF current ripple must not exceed this value.

Max. permissible peak current ... The max. output peak current of the LED driver must not exceed this value.

5.2 Typ. forward voltage vs. forward current

SLE 04mm 800lm ADV8

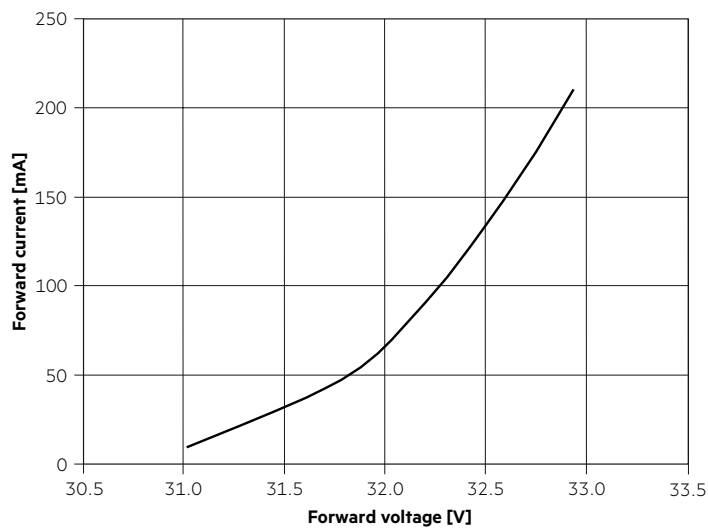

SLE 06mm 1600lm ADV8

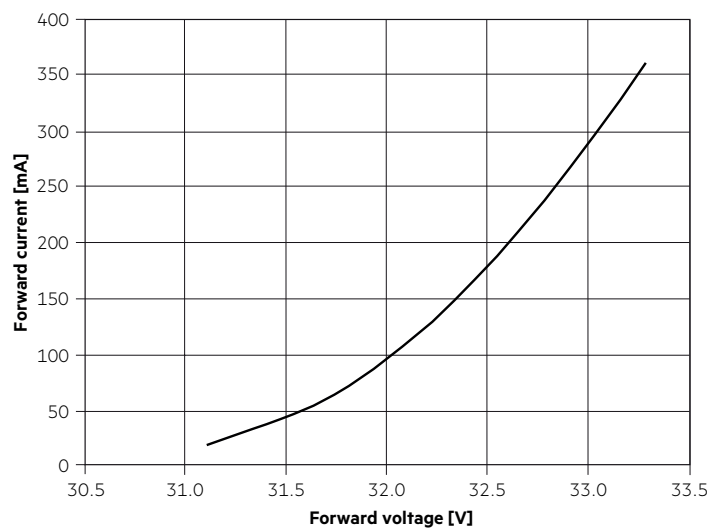

SLE 09mm 800lm ADV8

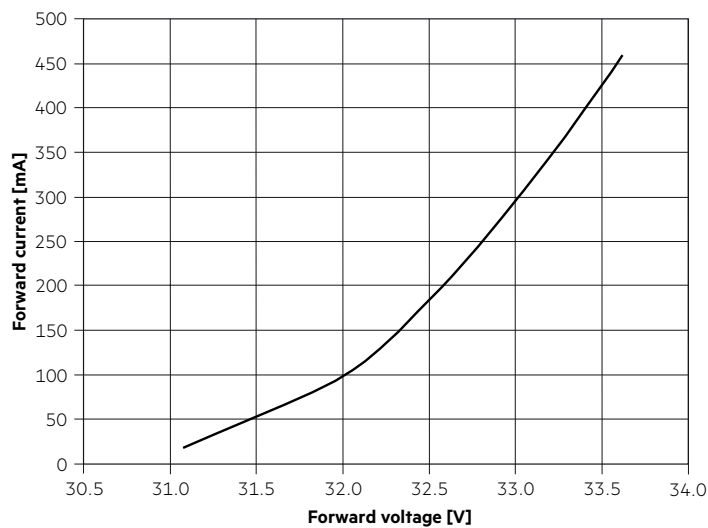

SLE 09mm 1200lm ADV8

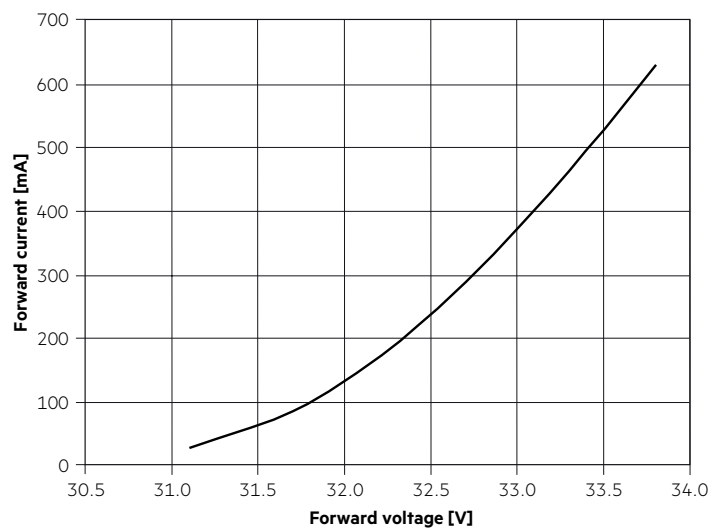

SLE 09mm 2600lm ADV8

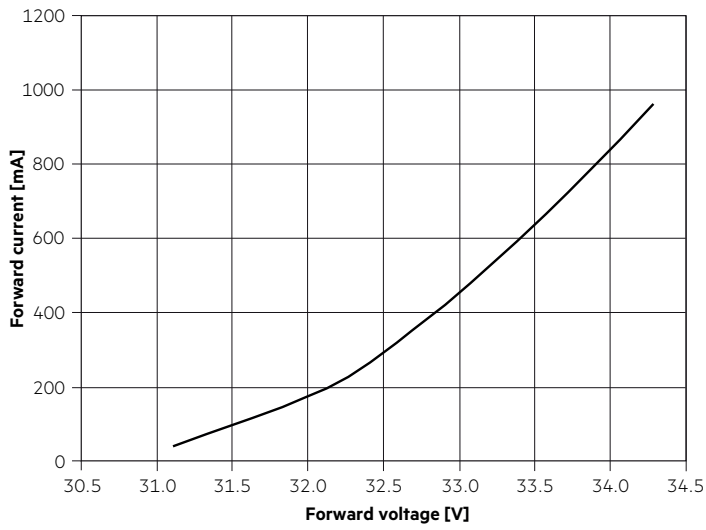

SLE 13mm 3000lm ADV8

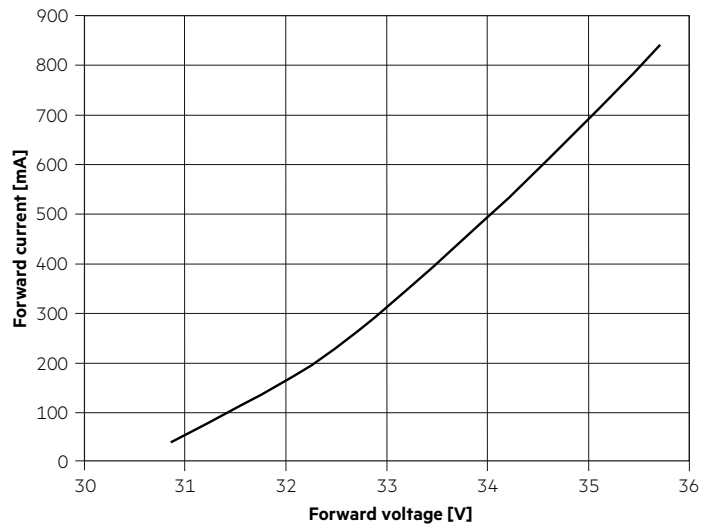

SLE 15mm 4000lm ADV8

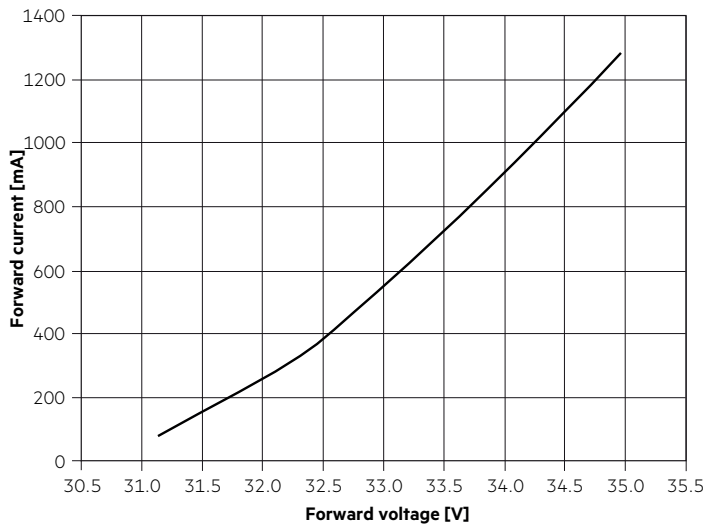

SLE 17mm 5000lm ADV8

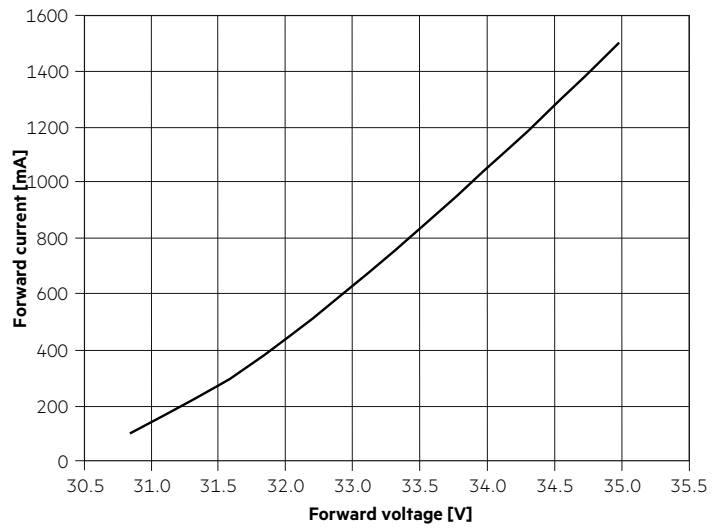

SLE 21mm 6000lm ADV8

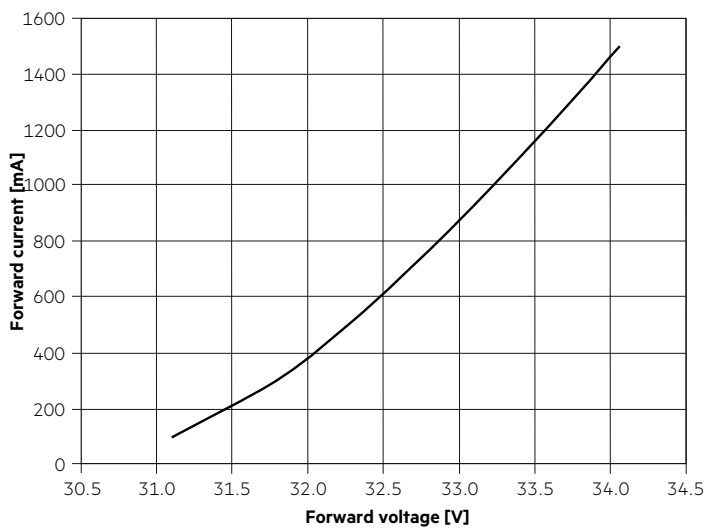

5.3 Forward voltage vs. tp temperature

SLE 04mm 800lm ADV8

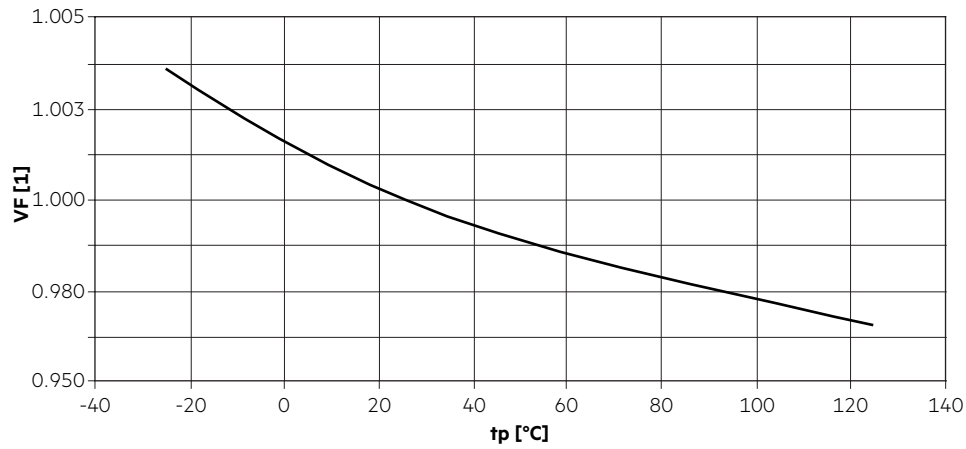

SLE 06mm 1600lm ADV8

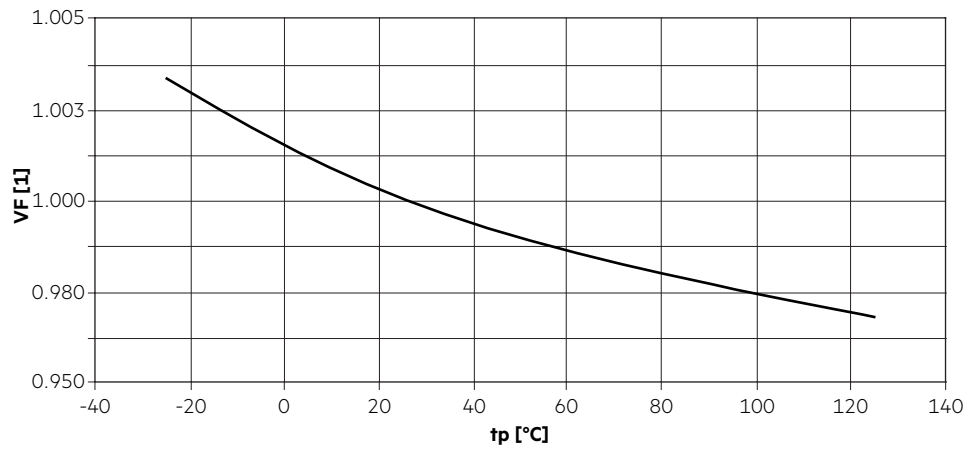

SLE 09mm 800lm ADV8

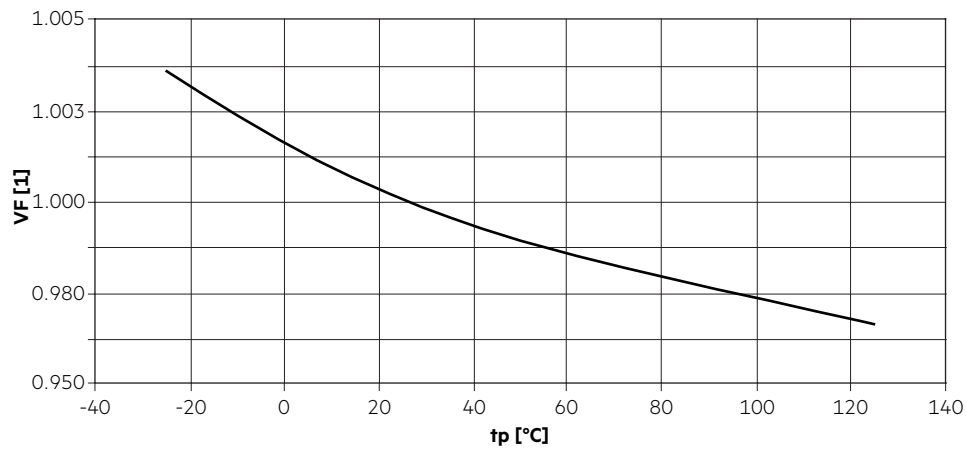

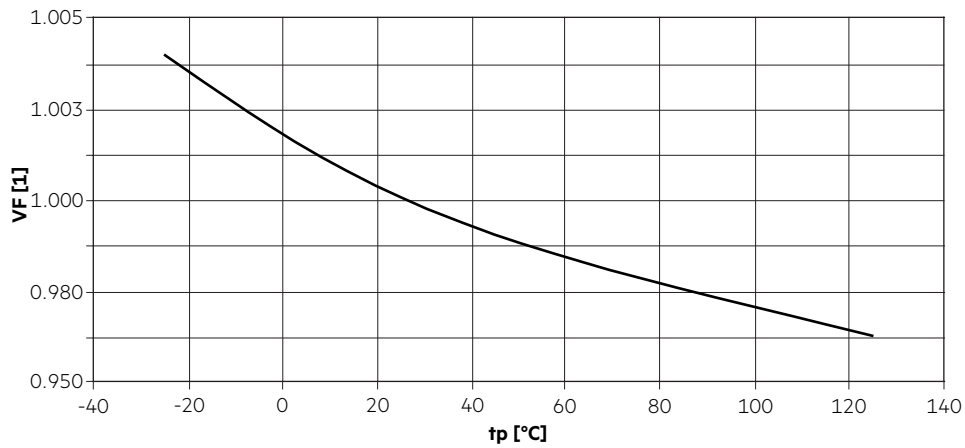
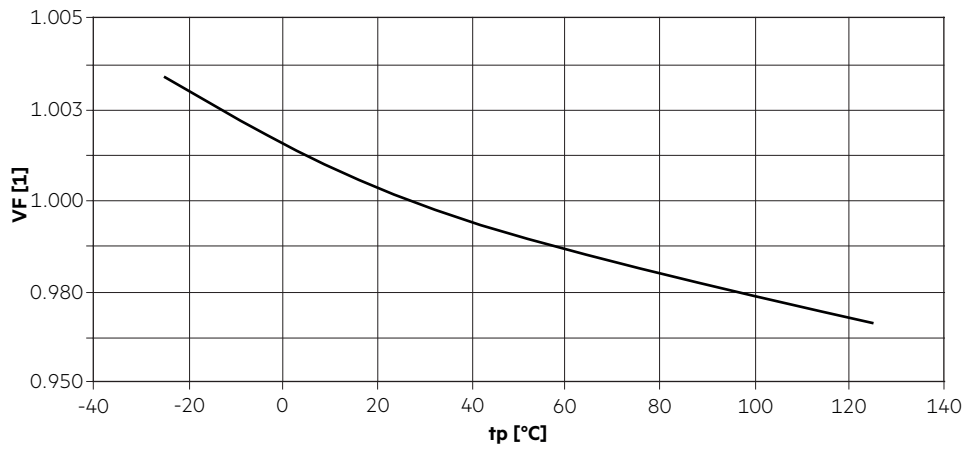
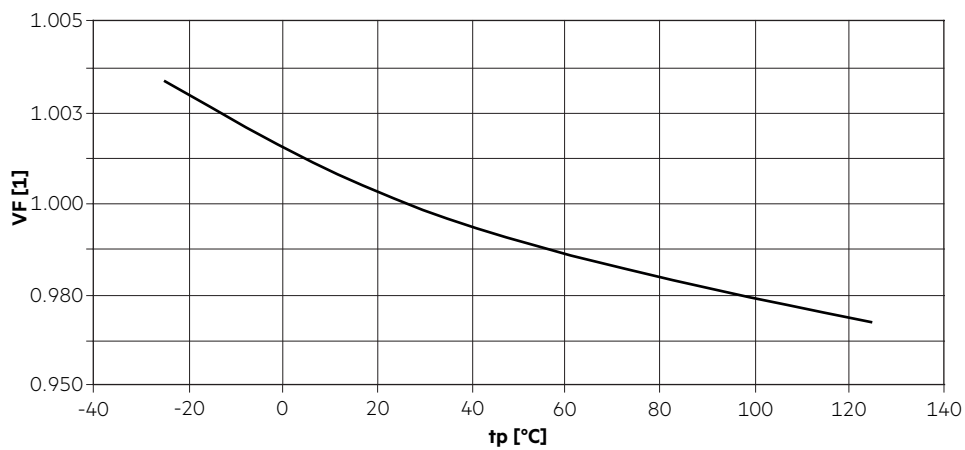
SLE 09mm 1200lm ADV8**SLE 09mm 2600lm ADV8****SLE 13mm 3000lm ADV8**

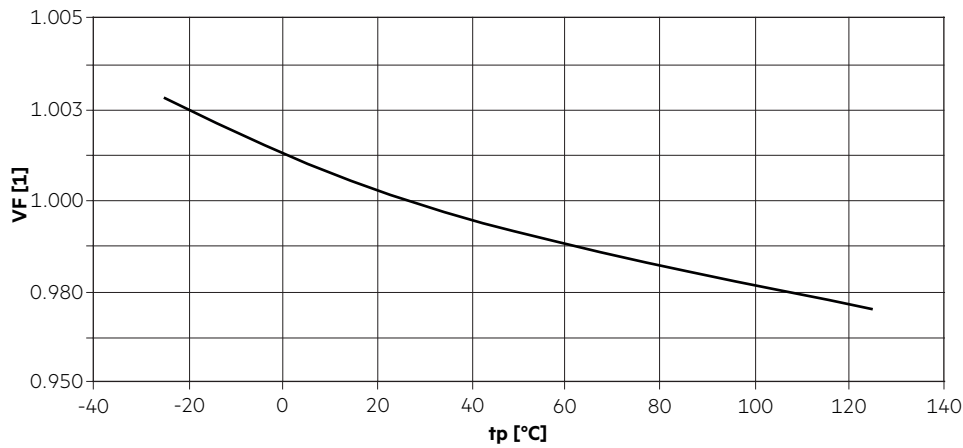
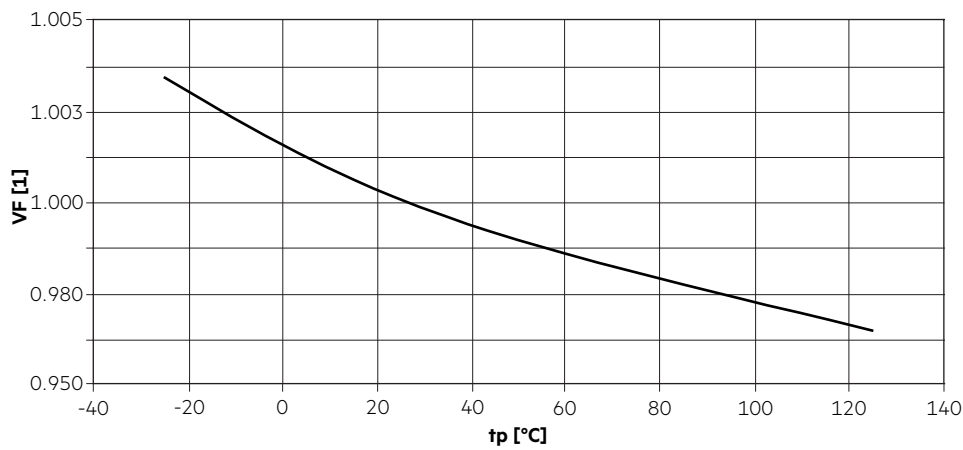
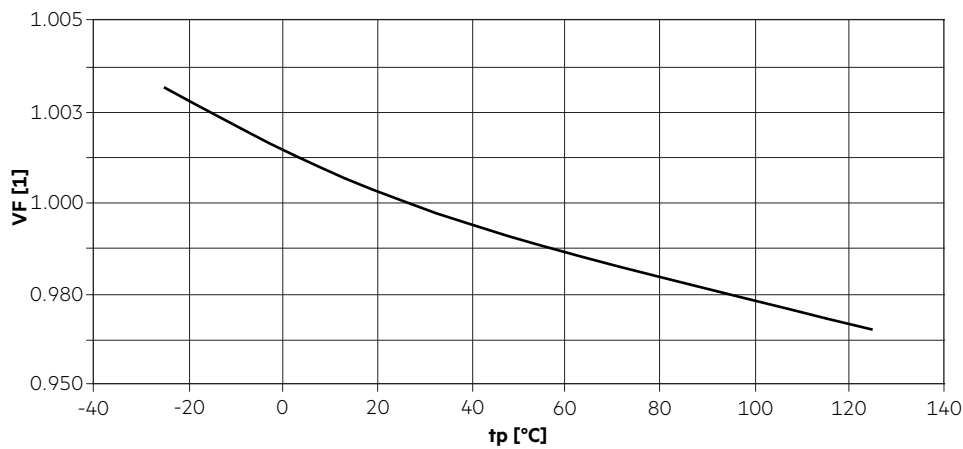
SLE 15mm 4000lm ADV8**SLE 17mm 5000lm ADV8****SLE 21mm 6000lm ADV8**

The diagrams based on statistic values.
The real values can be different.

3,000 K – CRI90

	x0	y0
Centre	0.4369	0.4041

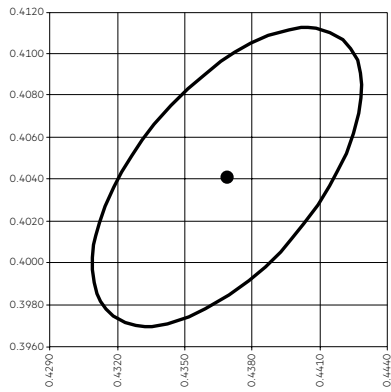

MacAdam ellipse: 3SDCM

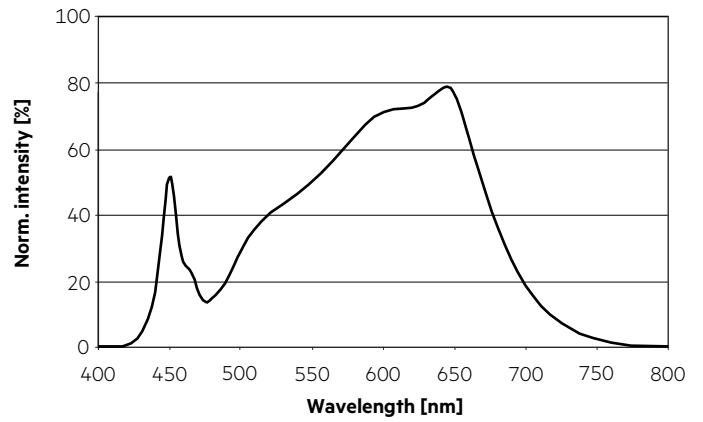

CRI	
Ra	R9
92	64

Colour vector graphic

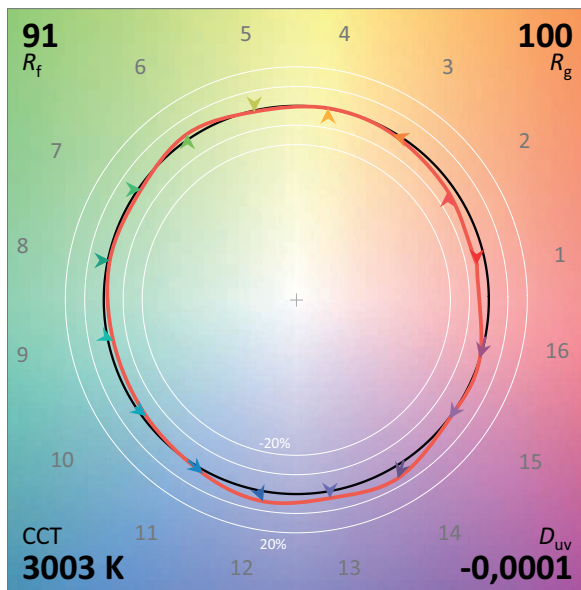

— Reference source
 — Test source

3,500 K – CRI90

	x0	y0
Centre	0.4053	0.3907

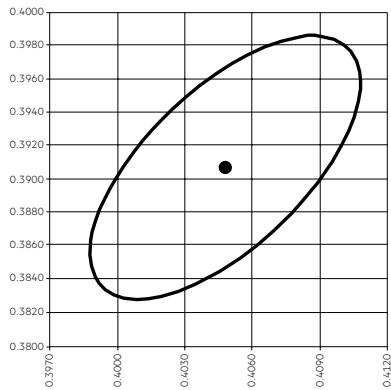

MacAdam ellipse: 3SDCM

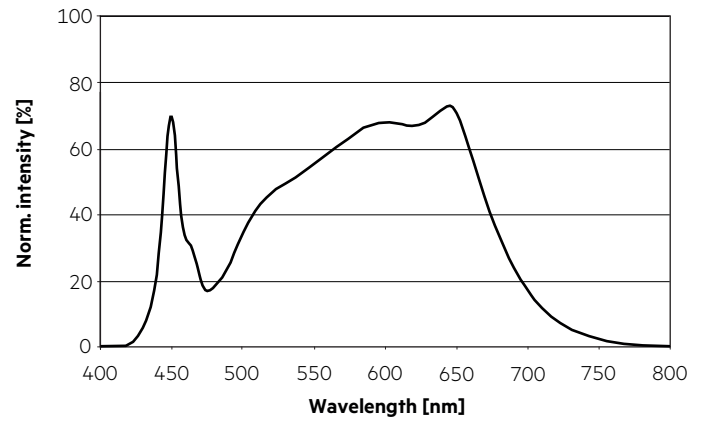

CRI	
Ra	R9
93	70

Colour vector graphic

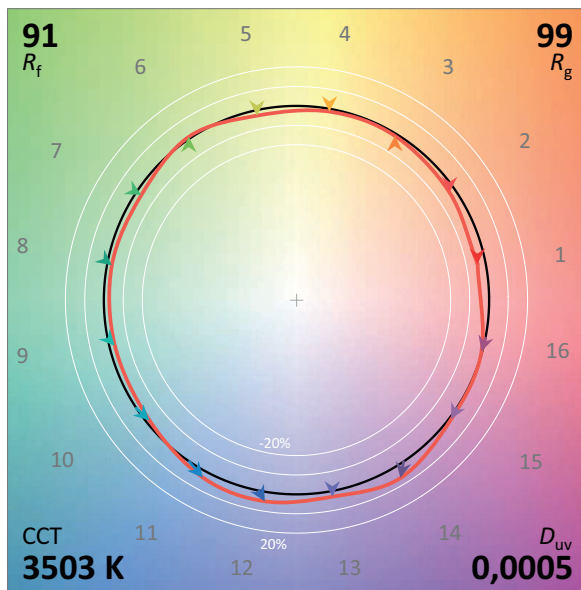

— Reference source
 — Test source

4,000 K – CRI90

	x0	y0
Centre	0.3804	0.3767

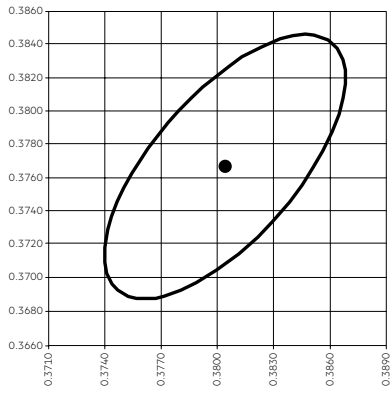

MacAdam ellipse: 3SDCM

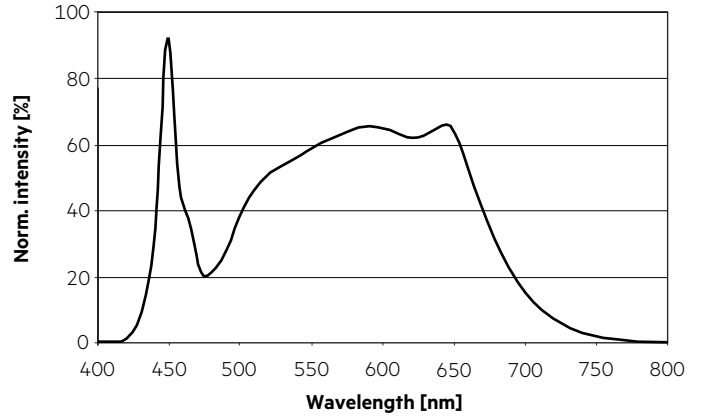

CRI	
Ra	R9
93	72

Colour vector graphic

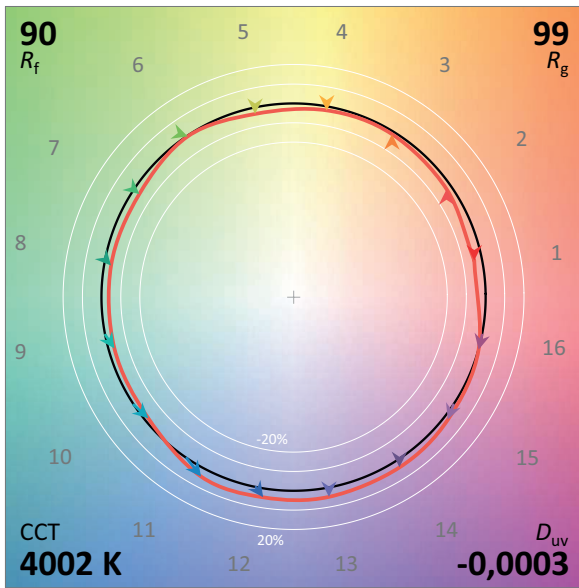

— Reference source
 — Test source

6.2 Light distribution

The optical design of the SLE product line ensures optimum homogeneity for the light distribution.

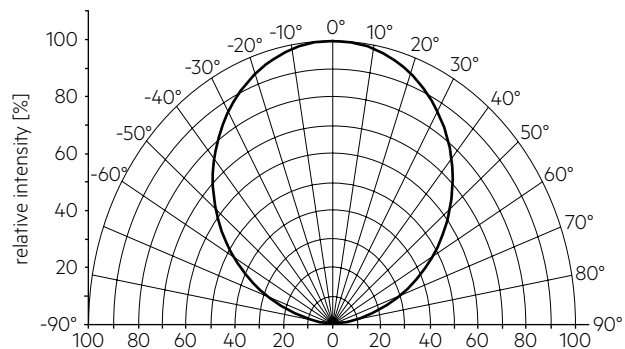

6.3 Relative luminous flux vs. tp temperature

SLE 04mm 800lm ADV8

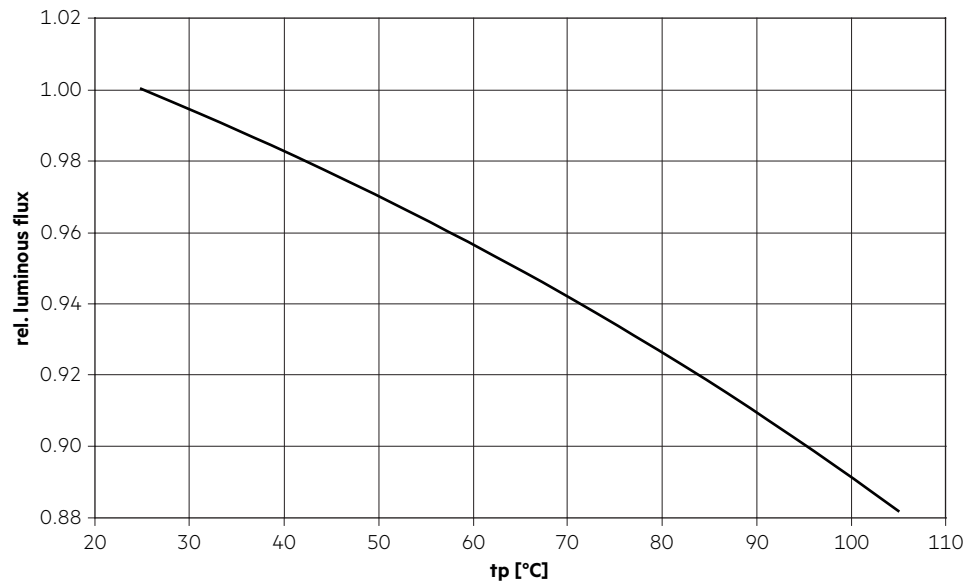

SLE 06mm 1600lm ADV8

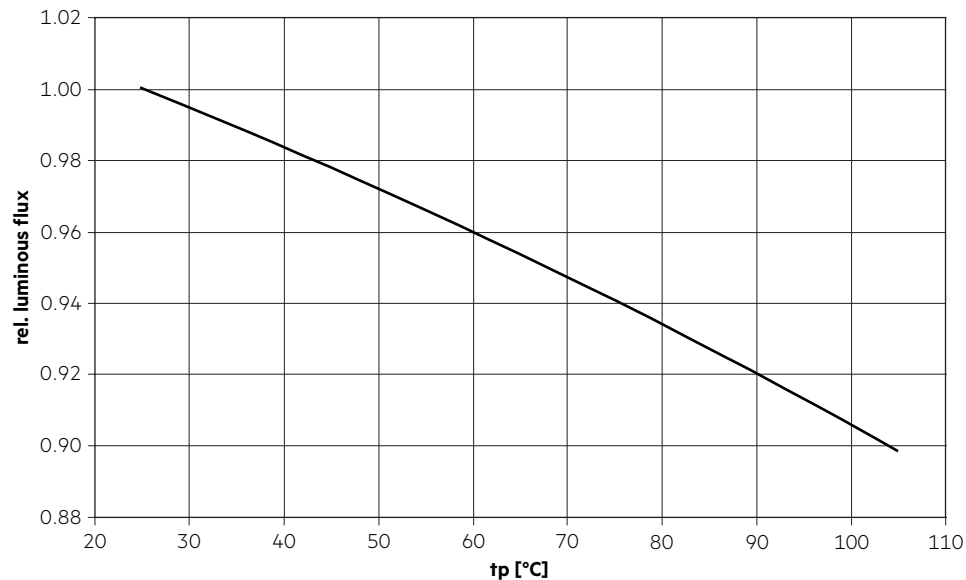

SLE 09mm 800lm ADV8

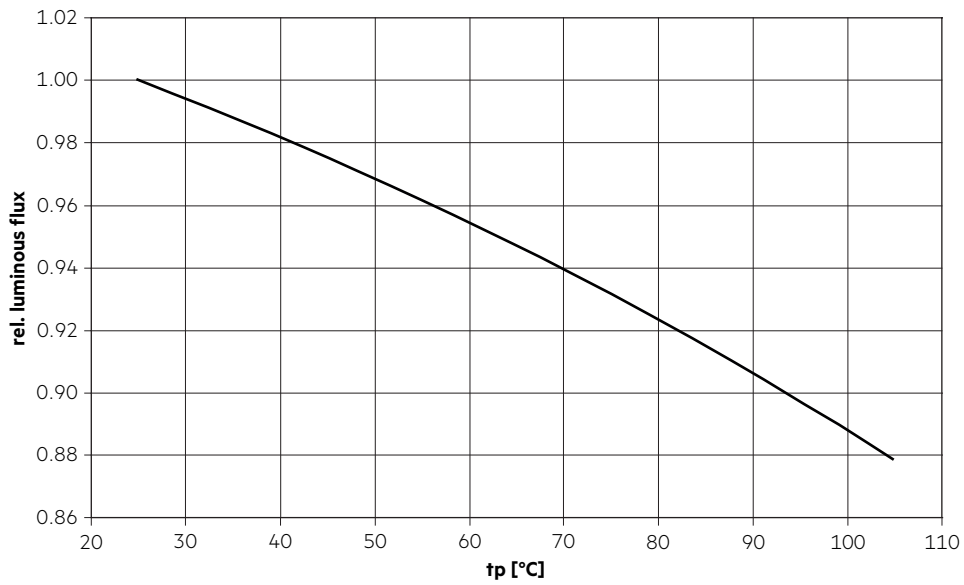

SLE 09mm 1200lm ADV8

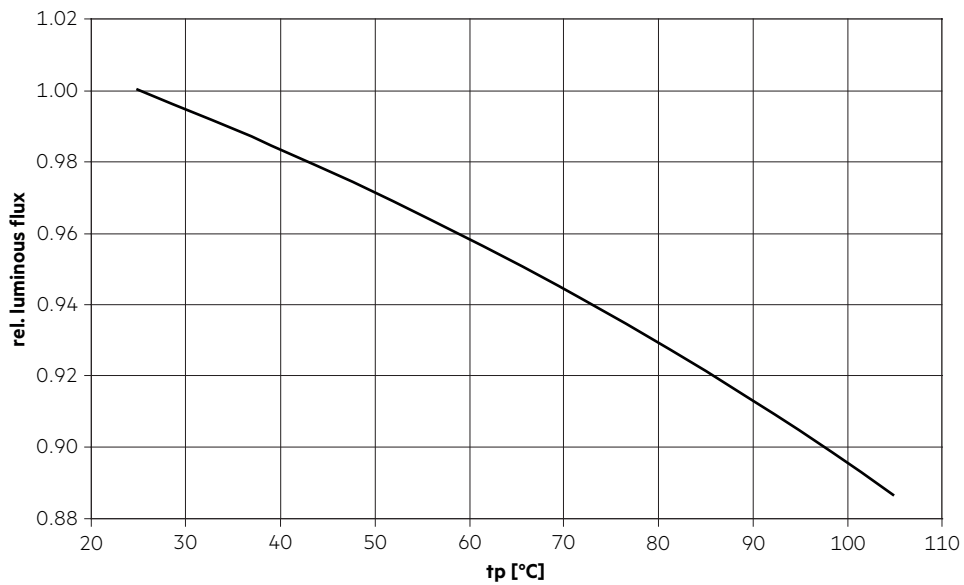

SLE 09mm 2600lm ADV8

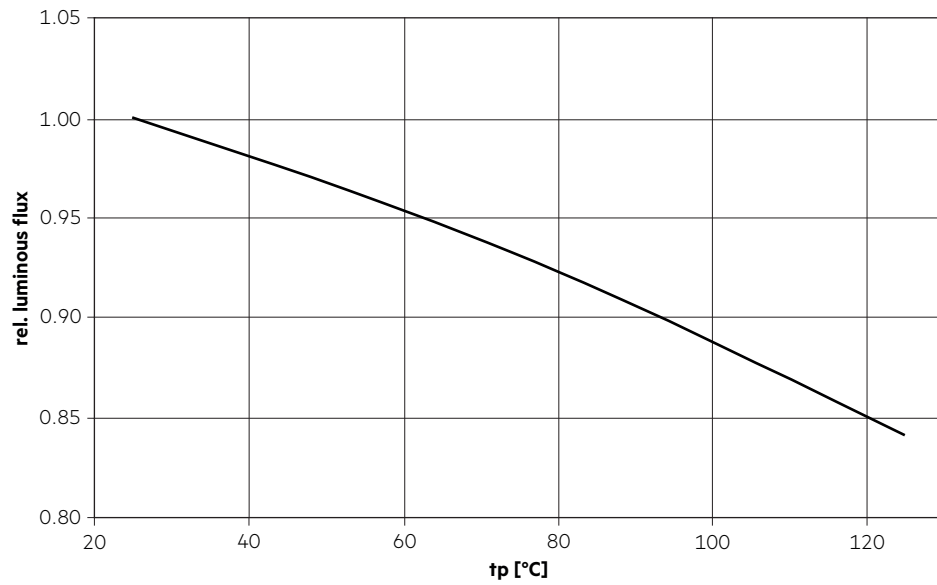

SLE 13mm 3000lm ADV8

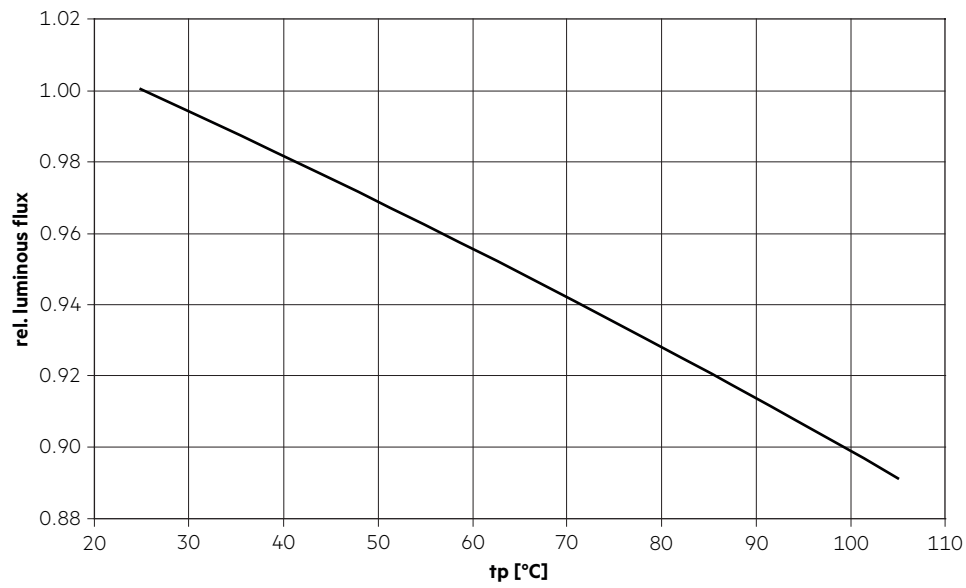

SLE 15mm 4000lm ADV8

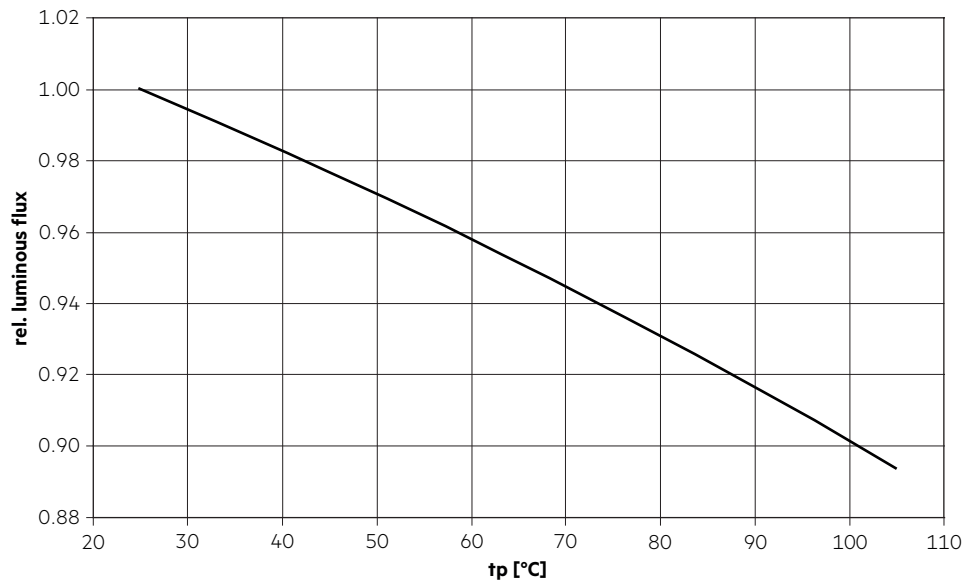

SLE 17mm 5000lm ADV8

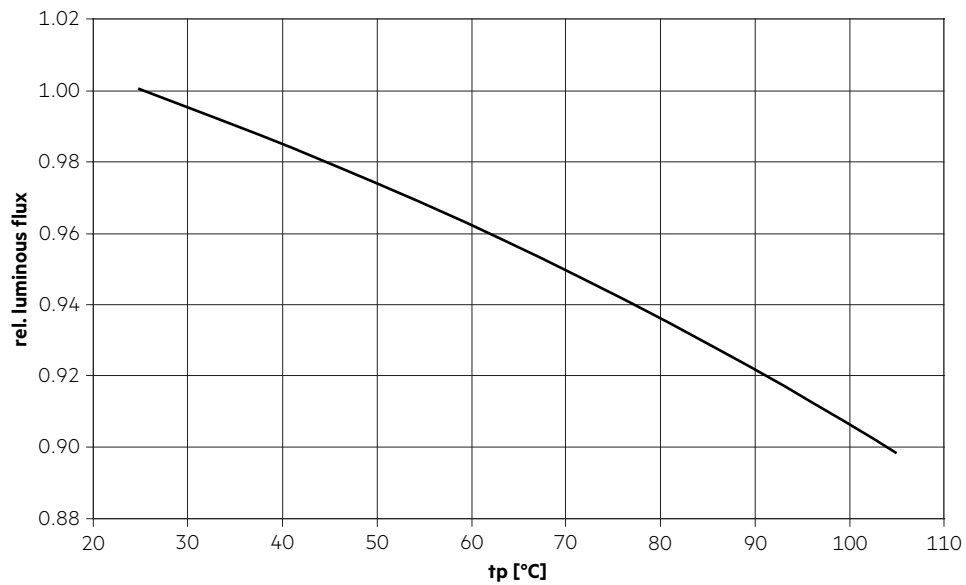

SLE 21mm 6000lm ADV8

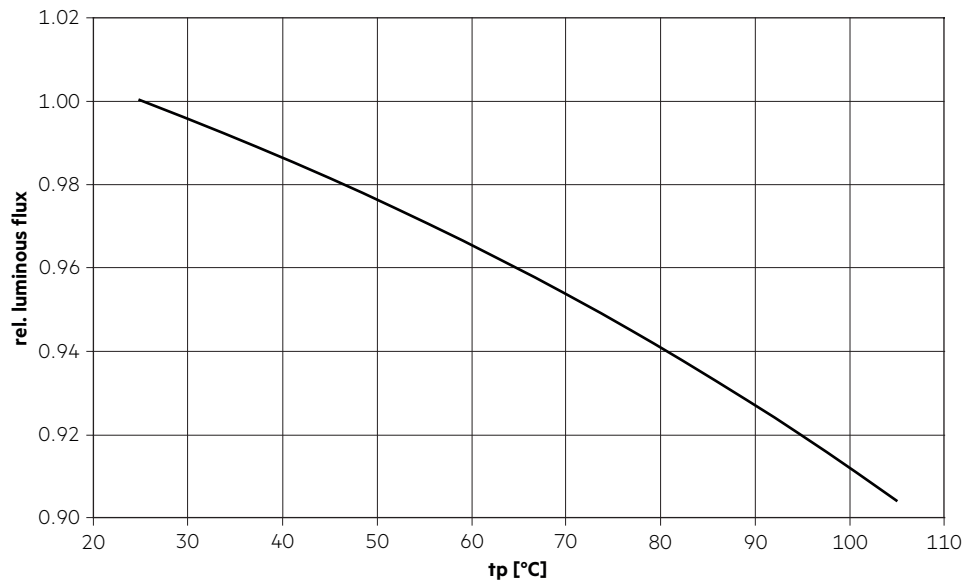

6.4 Relative luminous flux vs. operating current

SLE 04mm 800lm ADV8

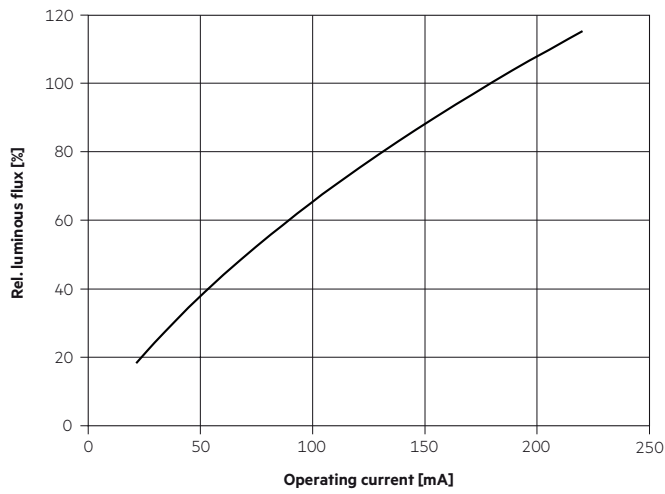

SLE 06mm 1600lm ADV8

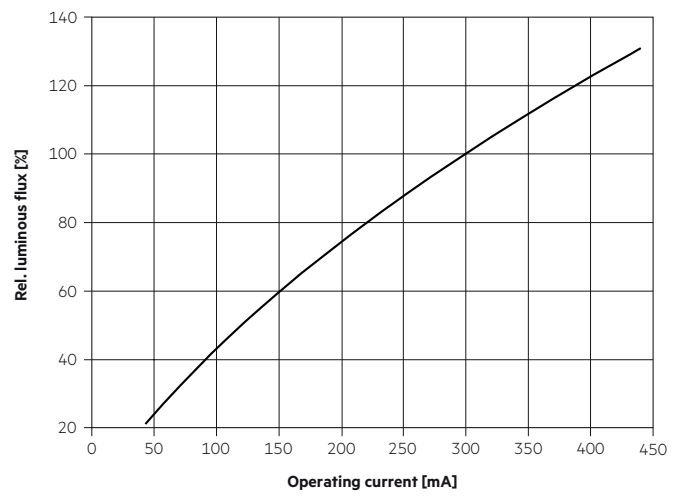

SLE 09mm 800lm ADV8

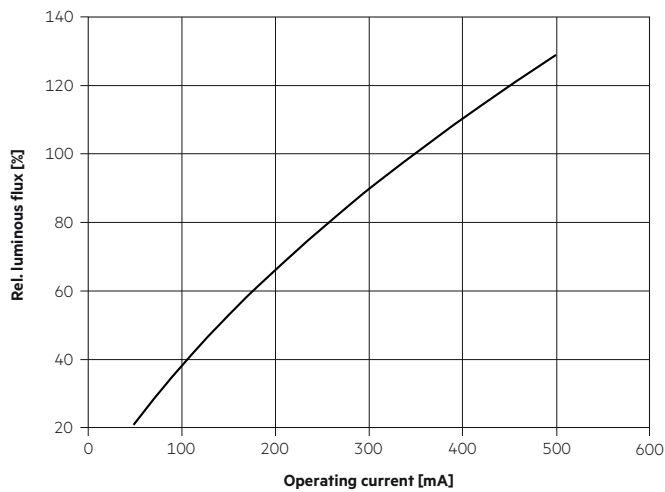

SLE 09mm 1200lm ADV8

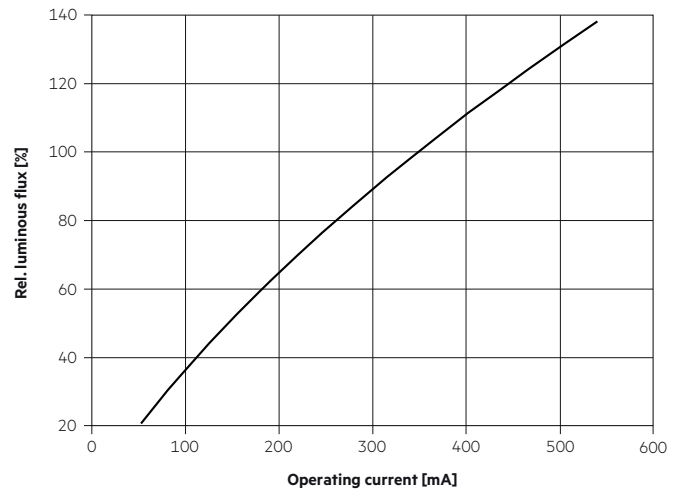

SLE 09mm 2600lm ADV8

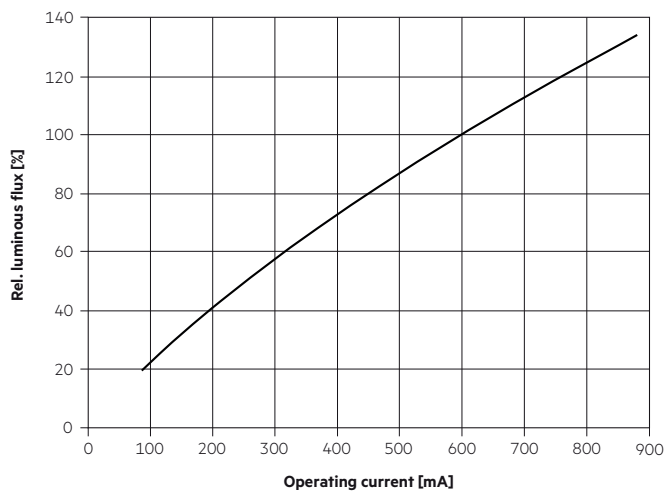

SLE 13mm 3000lm ADV8

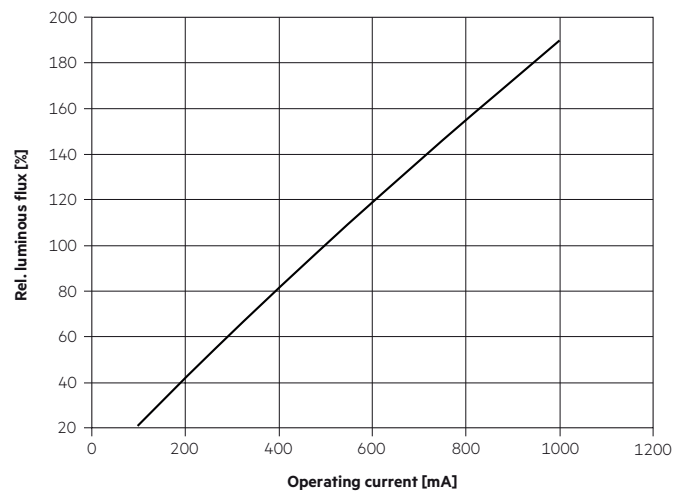

SLE 15mm 4000lm ADV8

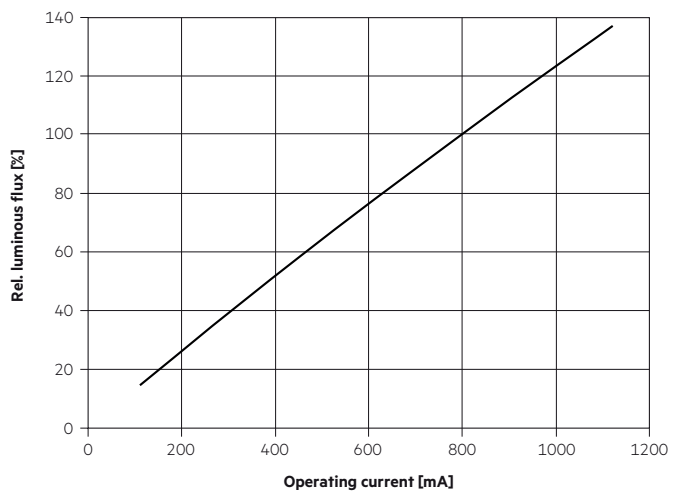

SLE 17mm 5000lm ADV8

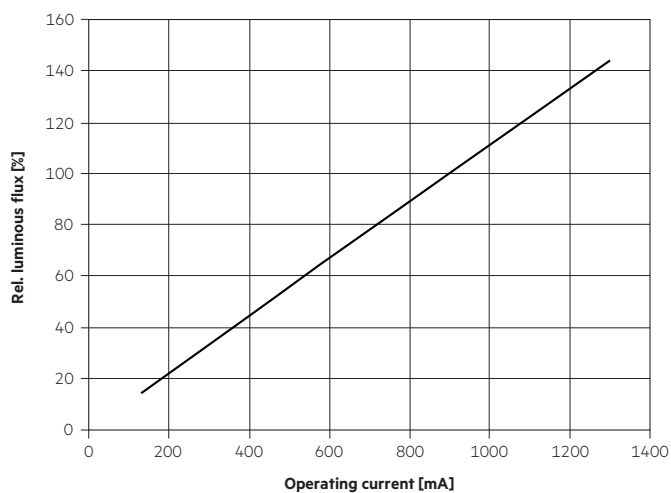

SLE 21mm 6000lm ADV8

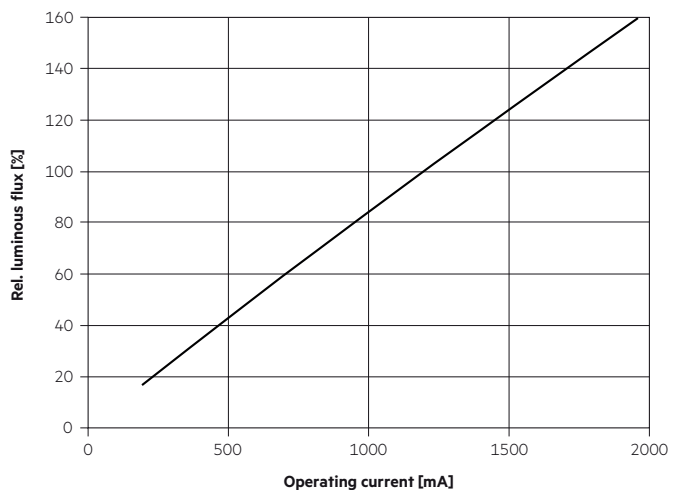

7. Miscellaneous

7.1 Additional information

Additional technical information at www.tridonic.com → Technical Data

Energy label and further information at www.tridonic.com in the certificates tab of the corresponding product page and at the EPREL data base <https://eprel.ec.europa.eu/>

Guarantee conditions at www.tridonic.com → Services

Lifetime declarations are informative and represent no warranty claim.