

Module LLE 20x280-560mm 1250lm HV SNC4

Modules LLE essence



LLE 20x70mm 325lm HV SNC4 QTY4



LLE 20x140mm 650lm HV SNC4



LLE 20x280mm 1250lm HV SNC4

Product description

- _ Ideal for linear and panel lights
- _ 2 terminals for serial wiring
- _ Perfectly uniform light, even if several LED modules are used together in a line
- _ Push terminals for quick and simple wiring of LED module to LED module
- _ HE ... High Efficiency, NM ... Nominal Mode, HO ... High Output
- _ Min. order quantity LLE 20x70mm QTY4: 36 pcs. The LLE 20x70mm QTY4 module contains 4 single 20x70mm modules which have to be separated
- _ Long lifetime up to 72,000 hours (for details 4.2 Lumen maintenance)
- _ 5 years guarantee (conditions at <https://www.tridonic.com/en/int/services/manufacturer-guarantee-conditions>)

Optical properties

- _ Colour temperatures 3,000, 4,000, 5,000 and 6,500 K
- _ Efficacy of the LED module up to 190 lm/W
- _ High colour rendering index CRI > 80
- _ Small colour tolerance (MacAdam 3) ^①
- _ Small luminous flux tolerances

Mechanical properties

- _ Module dimension 20 x 70 mm, 20 x 140 mm, 20 x 280 mm and 20 x 560 mm
- _ Simple installation (e.g. screws)

^① Integral measurement over the complete module.

Website

<http://www.tridonic.com/28005973>

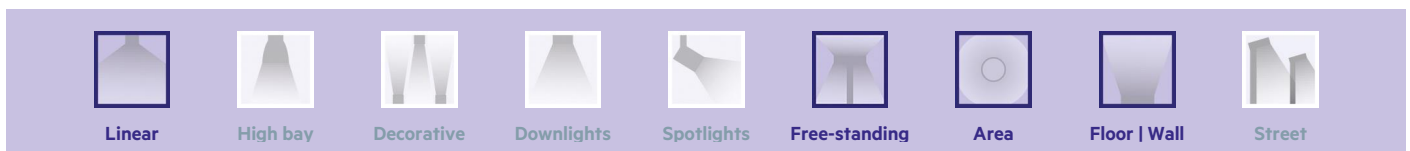
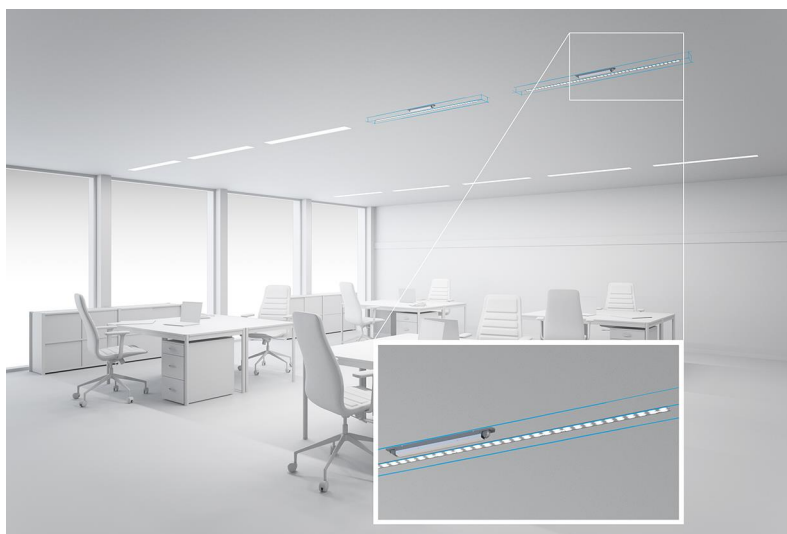

Module LLE 20x280-560mm 1250lm HV SNC4

Modules LLE essence

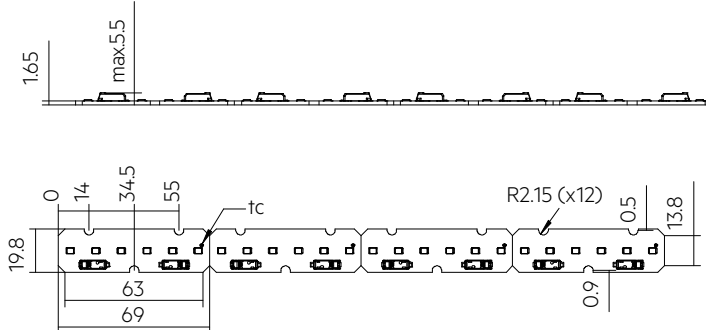

LLE 20x70mm 325lm HV SNC4 QTY4

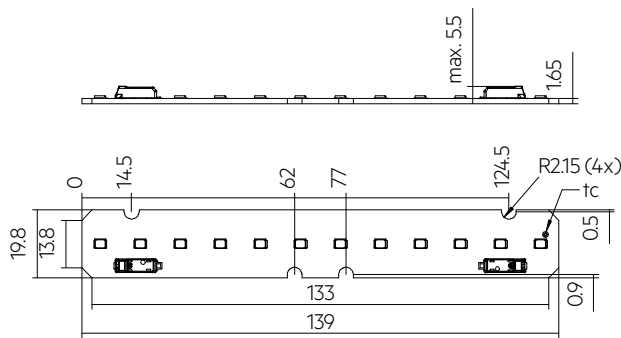

LLE 20x140mm 650lm HV SNC4

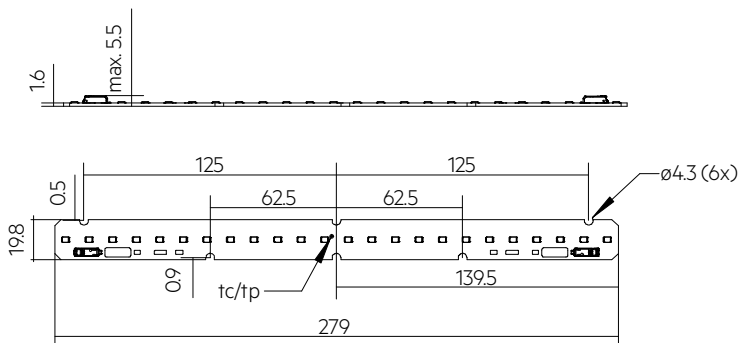

LLE 20x280mm 1250lm HV SNC4

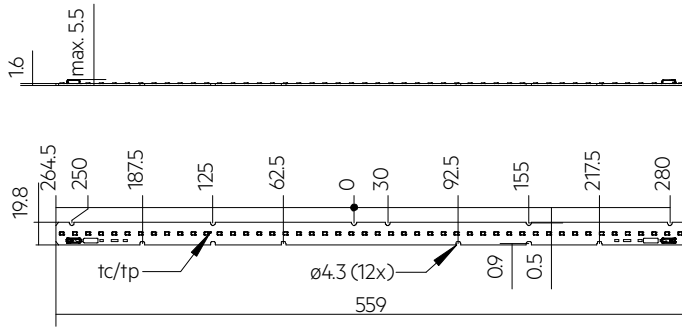

LLE 20x560mm 2400lm HV SNC4

Ordering data

Type	Article number	Colour temperature	Packaging, carton	Weight per pc.
LLE 20x70mm 325lm 830 HV SNC4 QTY4	28005973	3,000 K	108 pc(s).	0.016 kg
LLE 20x70mm 325lm 840 HV SNC4 QTY4	28005974	4,000 K	108 pc(s).	0.016 kg
LLE 20x140mm 650lm 830 HV SNC4	28005975	3,000 K	108 pc(s).	0.008 kg
LLE 20x140mm 650lm 840 HV SNC4	28005976	4,000 K	108 pc(s).	0.008 kg
LLE 20x280mm 1250lm 830 HV SNC4	28005433	3,000 K	108 pc(s).	0.015 kg
LLE 20x280mm 1250lm 840 HV SNC4	28005434	4,000 K	108 pc(s).	0.015 kg
LLE 20x280mm 1250lm 850 HV SNC4	28005435	5,000 K	108 pc(s).	0.015 kg
LLE 20x280mm 1250lm 865 HV SNC4	28005436	6,500 K	108 pc(s).	0.015 kg
LLE 20x560mm 2400lm 830 HV SNC4	28005440	3,000 K	108 pc(s).	0.030 kg
LLE 20x560mm 2400lm 840 HV SNC4	28005441	4,000 K	108 pc(s).	0.030 kg
LLE 20x560mm 2400lm 850 HV SNC4	28005442	5,000 K	108 pc(s).	0.030 kg
LLE 20x560mm 2400lm 865 HV SNC4	28005443	6,500 K	108 pc(s).	0.030 kg

Technical data

Beam characteristic	120°
Ambient temperature t_a	-40 ... +65 °C
t_p rated	50 °C
t_c	90 °C
I_{rated}	300 mA
I_{max}	700 mA
Max. permissible LF current ripple	800 mA
Max. permissible peak current	1,350 mA / max. 10 ms
Max. working voltage for insulation [®]	400 V
Insulation test voltage	1.8 kV
Colour tolerance [®]	3 SDCM
ESD classification	Severity level 2
Risk group (IEC 62471) [®]	RG1
Classification acc. to IEC 62031	Built-in
Type of protection	IP00
Lumen maintenance L70B50	72,000 h
Guarantee (conditions at www.tridonic.com)	5 Year(s)

Approval marks**Standards**

IEC 62031, IEC 62471, IEC 61000-4-2, IEC 62778, IEC 61547

Specific technical data

Type	Article number	Photometric code	Useful luminous flux at tp = 25 °C ^①	Expected luminous flux at tp rated ^②	Typ. forward current	Min. forward voltage at tp rated	Max. forward voltage at tp = 25 °C	Power consumption Pon at tp = 25 °C ^③	Efficacy of the module at tp = 25 °C	Expected efficacy of the module at tp rated	Colour rendering index CRI
Operating mode HE											
LLE 20x70mm 325lm 830 HV SNC4 QTY4	28005973	830/369	-	104 lm	100 mA	5.1 V	5.6 V	-	-	196 lm/W	>80
LLE 20x70mm 325lm 840 HV SNC4 QTY4	28005974	840/359	-	109 lm	100 mA	5.1 V	5.6 V	-	-	206 lm/W	>80
LLE 20x140mm 650lm 830 HV SNC4	28005975	830/369	-	208 lm	100 mA	10.2 V	11.1 V	-	-	196 lm/W	>80
LLE 20x140mm 650lm 840 HV SNC4	28005976	840/359	-	218 lm	100 mA	10.2 V	11.1 V	-	-	206 lm/W	>80
LLE 20x280mm 1250lm 830 HV SNC4	28005433	830/359	-	415 lm	100 mA	20.1 V	22.4 V	-	-	197 lm/W	>80
LLE 20x280mm 1250lm 840 HV SNC4	28005434	840/359	-	436 lm	100 mA	20.1 V	22.4 V	-	-	207 lm/W	>80
LLE 20x280mm 1250lm 850 HV SNC4	28005435	850/359	-	436 lm	100 mA	20.1 V	22.4 V	-	-	207 lm/W	>80
LLE 20x280mm 1250lm 865 HV SNC4	28005436	865/359	-	424 lm	100 mA	20.1 V	22.4 V	-	-	201 lm/W	>80
LLE 20x560mm 2400lm 830 HV SNC4	28005440	830/359	-	830 lm	100 mA	40.3 V	44.9 V	-	-	196 lm/W	>80
LLE 20x560mm 2400lm 840 HV SNC4	28005441	840/359	-	872 lm	100 mA	40.3 V	44.9 V	-	-	206 lm/W	>80
LLE 20x560mm 2400lm 850 HV SNC4	28005442	850/359	-	872 lm	100 mA	40.3 V	44.9 V	-	-	206 lm/W	>80
LLE 20x560mm 2400lm 865 HV SNC4	28005443	865/359	-	847 lm	100 mA	40.3 V	44.9 V	-	-	200 lm/W	>80
Operating mode NM											
LLE 20x70mm 325lm 830 HV SNC4 QTY4	28005973	830/369	305 lm	295 lm	300 mA	5.4 V	5.8 V	1.7 W	179 lm/W	176 lm/W	>80
LLE 20x70mm 325lm 840 HV SNC4 QTY4	28005974	840/359	320 lm	309 lm	300 mA	5.4 V	5.8 V	1.7 W	188 lm/W	185 lm/W	>80
LLE 20x140mm 650lm 830 HV SNC4	28005975	830/369	610 lm	589 lm	300 mA	10.7 V	11.7 V	3.4 W	179 lm/W	176 lm/W	>80
LLE 20x140mm 650lm 840 HV SNC4	28005976	840/359	640 lm	619 lm	300 mA	10.7 V	11.7 V	3.4 W	188 lm/W	185 lm/W	>80
LLE 20x280mm 1250lm 830 HV SNC4	28005433	830/359	1,220 lm	1,179 lm	300 mA	21.2 V	23.6 V	6.8 W	179 lm/W	177 lm/W	>80
LLE 20x280mm 1250lm 840 HV SNC4	28005434	840/359	1,285 lm	1,237 lm	300 mA	21.2 V	23.6 V	6.8 W	189 lm/W	186 lm/W	>80
LLE 20x280mm 1250lm 850 HV SNC4	28005435	850/359	1,278 lm	1,237 lm	300 mA	21.2 V	23.6 V	6.8 W	188 lm/W	186 lm/W	>80
LLE 20x280mm 1250lm 865 HV SNC4	28005436	865/359	1,245 lm	1,203 lm	300 mA	21.2 V	23.6 V	6.8 W	183 lm/W	180 lm/W	>80
LLE 20x560mm 2400lm 830 HV SNC4	28005440	830/359	2,440 lm	2,357 lm	300 mA	42.4 V	47.1 V	13.5 W	181 lm/W	177 lm/W	>80
LLE 20x560mm 2400lm 840 HV SNC4	28005441	840/359	2,570 lm	2,475 lm	300 mA	42.4 V	47.1 V	13.5 W	190 lm/W	186 lm/W	>80
LLE 20x560mm 2400lm 850 HV SNC4	28005442	850/359	2,556 lm	2,475 lm	300 mA	42.4 V	47.1 V	13.5 W	189 lm/W	186 lm/W	>80
LLE 20x560mm 2400lm 865 HV SNC4	28005443	865/359	2,491 lm	2,406 lm	300 mA	42.4 V	47.1 V	13.5 W	185 lm/W	180 lm/W	>80
Operating mode HO											
LLE 20x70mm 325lm 830 HV SNC4 QTY4	28005973	830/369	-	550 lm	600 mA	5.7 V	6.2 V	-	-	156 lm/W	>80
LLE 20x70mm 325lm 840 HV SNC4 QTY4	28005974	840/359	-	577 lm	600 mA	5.7 V	6.2 V	-	-	164 lm/W	>80
LLE 20x140mm 650lm 830 HV SNC4	28005975	830/369	-	1,100 lm	600 mA	11.4 V	12.3 V	-	-	156 lm/W	>80
LLE 20x140mm 650lm 840 HV SNC4	28005976	840/359	-	1,154 lm	600 mA	11.4 V	12.3 V	-	-	164 lm/W	>80
LLE 20x280mm 1250lm 830 HV SNC4	28005433	830/359	-	2,119 lm	600 mA	22.5 V	24.9 V	-	-	156 lm/W	>80
LLE 20x280mm 1250lm 840 HV SNC4	28005434	840/359	-	2,309 lm	600 mA	22.5 V	24.9 V	-	-	164 lm/W	>80
LLE 20x280mm 1250lm 850 HV SNC4	28005435	850/359	-	2,309 lm	600 mA	22.5 V	24.9 V	-	-	164 lm/W	>80
LLE 20x280mm 1250lm 865 HV SNC4	28005436	865/359	-	2,244 lm	600 mA	22.5 V	24.9 V	-	-	159 lm/W	>80
LLE 20x560mm 2400lm 830 HV SNC4	28005440	830/359	-	4,398 lm	600 mA	45.0 V	49.8 V	-	-	156 lm/W	>80
LLE 20x560mm 2400lm 840 HV SNC4	28005441	840/359	-	4,618 lm	600 mA	45.0 V	49.8 V	-	-	164 lm/W	>80
LLE 20x560mm 2400lm 850 HV SNC4	28005442	850/359	-	4,618 lm	600 mA	45.0 V	49.8 V	-	-	164 lm/W	>80
LLE 20x560mm 2400lm 865 HV SNC4	28005443	865/359	-	4,489 lm	600 mA	45.0 V	49.8 V	-	-	159 lm/W	>80

① Integral measurement over the complete module.

② If mounted with M4 screws and plastic washers.

③ Measured at operating mode HO.

④ Tolerance of useful light flux - 0 % / + 15 %. Measurement uncertainty ± 10 %.

⑤ Tolerance of expected light flux - 10 % / + 10 %. Measurement uncertainty ± 10 %. Based on calculation.

⑥ Tolerance of power consumption Pon ± 10 %. Measurement uncertainty ± 5 %.

ACL ENDCAP LLE

Accessory

**Product description**

- _ ENDCAP for LLE
- _ PUSH-FIX: Fast snap on mounting (sheet thickness 0.5 – 1.0 mm), for drilling hole 4 mm
- _ SCREW-FIX: Screw mounting with EJOT Delta PT WN 5451 30x8 (not included), tightening torque 0.7 Nm
- _ Clip made of polycarbonate

Website

<http://www.tridonic.com/28004379>

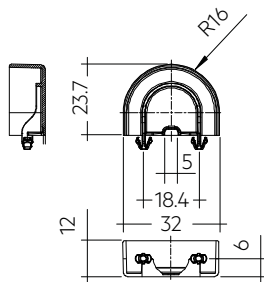
**Ordering data**

Type	Article number	Colour	Packaging, carton	Weight per pc.
ACL ENDCAP LLE20 PUSH-FIX	28004379	White	1,500 pc(s).	0.003 kg
ACL ENDCAP LLE24 PUSH-FIX	28001037	White	480 pc(s).	0.003 kg
ACL ENDCAP LLE24 SCREW-FIX	28002315	White	480 pc(s).	0.003 kg

ACL LINEAR LENS 24mm

Accessory

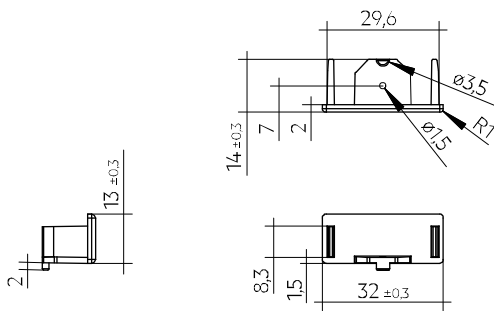
**Product description LINEAR LENS**

- _ Linear lens for LLE 20 / 24
- _ Available with different beam characteristics
- _ Protection against direct touch for non-SELV applications (recommendation: use all fixing points)
- _ Fast snap on mounting on to LLE 20: with M4 screws and plastic washers, to LLE 24: with clips or plastic washers
- _ Recommendation: Fastening with screws and plastic washers, see 2.3 Heat sink specifications in data sheet
- _ Material: PMMA
- _ Available lengths: 1,200, 1,500 and 1,800 mm, Tolerance: + 10 mm (ends raw)
- _ Max. permissible temperature 80 °C
- _ Photometric data available on website

Product description Endcap

- _ ENDCAP for LINEAR LENS 24mm INTENSE, ASY and DASY
- _ Mounting by clipping in and screwing from below using screw EJOT Delta PT WN 5451 20x4, tightening torque 0.7 Nm
- _ Made of Polyamide UL94 V0

Website

<http://www.tridonic.com/28001428>

**Ordering data**

Type	Article number	Length L	Beam characteristic	Efficiency	Packaging, carton	Weight per pc.
ACL LINEAR LENS 24x1200mm 60°	28001428	1,200 mm	60°	97 %	21 pc(s).	0.196 kg
ACL LINEAR LENS 24x1200mm 90°	28001429	1,200 mm	90°	97 %	21 pc(s).	0.165 kg
ACL LINEAR LENS 24x1500mm 60°	28000953	1,500 mm	60°	97 %	21 pc(s).	0.261 kg
ACL LINEAR LENS 24x1500mm 90°	28000955	1,500 mm	90°	97 %	21 pc(s).	0.221 kg
ACL LINEAR LENS 24x1200mm INTENSE	28002024	1,200 mm	40°	95 %	18 pc(s).	0.261 kg
ACL LINEAR LENS 24x1500mm INTENSE	28002025	1,500 mm	40°	95 %	18 pc(s).	0.326 kg
ACL LINEAR LENS 24x1800mm INTENSE	28002026	1,800 mm	40°	95 %	18 pc(s).	0.392 kg
ACL LINEAR LENS 24x1200mm ASY	28002030	1,200 mm	asymmetric	95 %	18 pc(s).	0.250 kg
ACL LINEAR LENS 24x1500mm ASY	28002031	1,500 mm	asymmetric	95 %	18 pc(s).	0.312 kg
ACL LINEAR LENS 24x1800mm ASY	28002032	1,800 mm	asymmetric	95 %	18 pc(s).	0.375 kg
ACL LINEAR LENS 24x1200mm DASY	28002033	1,200 mm	double asymmetric	92 %	18 pc(s).	0.249 kg
ACL LINEAR LENS 24x1500mm DASY	28002034	1,500 mm	double asymmetric	92 %	18 pc(s).	0.311 kg
ACL LINEAR LENS 24x1800mm DASY	28002035	1,800 mm	double asymmetric	92 %	18 pc(s).	0.373 kg
ACL Endcap LENS 24mm PSF	28002669	-	-	-	3,600 pc(s).	0.003 kg

1. Standards

IEC 62031
IEC 62471
IEC 61000-4-2
IEC 62778
IEC 61547

1.1 Photometric code

Key for photometric code, e. g. 830 / 349

1 st digit	2 nd + 3 rd digit	4 th digit	5 th digit	6 th digit
Code CRI	Colour temperature in Kelvin x 100	MacAdam initial	MacAdam after 25% of the lifetime (max.6000h)	Luminous flux after 25% of the lifetime (max.6000h)
7 70 – 79				Code Luminous flux
8 80 – 89				7 ≥ 70 %
9 ≥90				8 ≥ 80 % 9 ≥ 90 %

1.2 Energy classification

Type	Colour temperature	Forward current	Energy classification	Energy consumption
LLE 20x70mm 325lm 830 HV SNC4 QTY4	3,000 K	300 mA	C	2 kWh / 1,000 h
LLE 20x70mm 325lm 840 HV SNC4 QTY4	4,000 K	300 mA	C	2 kWh / 1,000 h
LLE 20x140mm 650lm 830 HV SNC4	3,000 K	300 mA	C	4 kWh / 1,000 h
LLE 20x140mm 650lm 840 HV SNC4	4,000 K	300 mA	C	4 kWh / 1,000 h
LLE 20x280mm 1250lm 830 HV SNC4	3,000 K	300 mA	C	7 kWh / 1,000 h
LLE 20x280mm 1250lm 840 HV SNC4	4,000 K	300 mA	C	7 kWh / 1,000 h
LLE 20x280mm 1250lm 850 HV SNC4	5,000 K	300 mA	C	7 kWh / 1,000 h
LLE 20x280mm 1250lm 865 HV SNC4	6,500 K	300 mA	C	7 kWh / 1,000 h
LLE 20x560mm 2400lm 830 HV SNC4	3,000 K	300 mA	C	14 kWh / 1,000 h
LLE 20x560mm 2400lm 840 HV SNC4	4,000 K	300 mA	C	14 kWh / 1,000 h
LLE 20x560mm 2400lm 850 HV SNC4	5,000 K	300 mA	C	14 kWh / 1,000 h
LLE 20x560mm 2400lm 865 HV SNC4	6,500 K	300 mA	C	14 kWh / 1,000 h

Energy label and further information at www.tridonic.com in the certificates tab of the corresponding product page and at the EPREL data base <https://eprel.ec.europa.eu/>

2. Thermal details

2.1 tc point, ambient temperature and lifetime

The temperature at tp reference point is crucial for the light output and lifetime of a LED product.

For LLE a tp temperature of 50 °C has to be complied in order to achieve an optimum between heat sink requirements, light output and lifetime.

Compliance with the maximum permissible reference temperature at the tc point must be checked under operating conditions in a thermally stable state. The maximum value must be determined under worst-case conditions for the relevant application.

The tc and tp temperature of LED modules from Tridonic are measured at the same reference point.

2.2 Storage and humidity

Storage temperature	-40 ... +85 °C
---------------------	----------------

Operation only in non condensing environment.

Humidity during processing of the module should be between 30 to 70 %.

2.3 Heat sink values

LLE 20x70mm 325lm 8xx HV SNC4 QTY4

ta	tp	Forward current	R _{th, hs-a}	Cooling area
25 °C	50 °C	300 mA	12.88 K/W	52 cm ²
25 °C	50 °C	700 mA	3.56 K/W	187 cm ²
35 °C	50 °C	300 mA	6.35 K/W	105 cm ²
35 °C	50 °C	700 mA	0.76 K/W	873 cm ²
40 °C	50 °C	300 mA	3.09 K/W	216 cm ²

LLE 20x140mm 650lm 8xx HV SNC4

ta	tp	Forward current	R _{th, hs-a}	Cooling area
25 °C	50 °C	300 mA	13.70 K/W	49 cm ²
25 °C	50 °C	700 mA	4.88 K/W	137 cm ²
35 °C	50 °C	300 mA	7.53 K/W	89 cm ²
35 °C	50 °C	700 mA	2.24 K/W	297 cm ²
40 °C	50 °C	300 mA	4.45 K/W	150 cm ²
40 °C	50 °C	700 mA	0.93 K/W	721 cm ²
45 °C	50 °C	300 mA	1.37 K/W	487 cm ²

LLE 20x280mm 1250lm 8xx HV SNC4

ta	tp	Forward current	R _{th, hs-a}	Cooling area
25 °C	50 °C	300 mA	6.46 K/W	103 cm ²
25 °C	50 °C	700 mA	2.28 K/W	293 cm ²
35 °C	50 °C	300 mA	3.54 K/W	189 cm ²
35 °C	50 °C	700 mA	1.02 K/W	651 cm ²
40 °C	50 °C	300 mA	2.07 K/W	322 cm ²
40 °C	50 °C	700 mA	0.40 K/W	1,679 cm ²
45 °C	50 °C	300 mA	0.61 K/W	1,098 cm ²

LLE 20x560mm 2400lm 8xx HV SNC4

ta	tp	Forward current	R _{th, hs-a}	Cooling area
25 °C	50 °C	300 mA	3.26 K/W	205 cm ²
25 °C	50 °C	700 mA	1.15 K/W	578 cm ²
35 °C	50 °C	300 mA	1.78 K/W	374 cm ²
35 °C	50 °C	700 mA	0.52 K/W	1,282 cm ²
40 °C	50 °C	300 mA	1.05 K/W	638 cm ²
40 °C	50 °C	700 mA	0.20 K/W	3,269 cm ²
45 °C	50 °C	300 mA	0.31 K/W	2,163 cm ²

Notes

The actual cooling surface can differ because of the material, the structural shape, outside influences and the installation situation. Depending on the heat sink a heat conducting paste or heat conducting film might be necessary to keep the specified tp temperature.

For applications with a small distance between LED module and lens, screw mounting is recommended to ensure a reliable thermal connection between LED module and cooling surface.

3. Installation / wiring

3.1 Electrical supply/choice of LED driver

LLE modules from Tridonic are not protected against overvoltages, overcurrents, overloads or short-circuit currents. Safe and reliable operation can only be guaranteed in conjunction with a LED driver which complies with the relevant standards. The use of LED driver from Tridonic in combination with LLE modules guarantees the necessary protection for safe and reliable operation.

If a LED driver other than Tridonic is used, it must provide the following protection:

- Short-circuit protection
- Overload protection
- Overtemperature protection



LLE modules must be supplied by a constant current LED driver. Operation with a constant voltage LED driver will lead to an irreversible damage of the module.

Wrong polarity can damage the LLE.

With parallel wiring tolerance-related differences in output are possible (thermal stress of the module) and can cause differences in brightness.

Wire breakage, poor contact or failure of individual modules can lead to very high temperatures at other modules within the luminaire. This can lead to total failure.

The max. permissible output current of the LED driver for parallel wiring is 1.8 A.

LLE can be operated either from SELV LED drivers or from LED drivers with LV output voltage.



LLE are basic insulated up to 400 V (if mounted with M4 screws with head diameter 7 mm in combination with plastic washers) against ground and can be mounted directly on earthed metal parts of the luminaire. If the max. output voltage of the LED driver (also against earth) is above 400 V, an additional insulation between LED module and heat sink is required (for example by insulated thermal pads) or by a suitable luminaire construction.

At voltages > 60 V an additional protection against direct touch (test finger) to the light emitting side of the module has to be guaranteed. This is typically achieved by means of a non removable light distributor over the module.

3.2 Wiring



Wiring examples for serial wiring

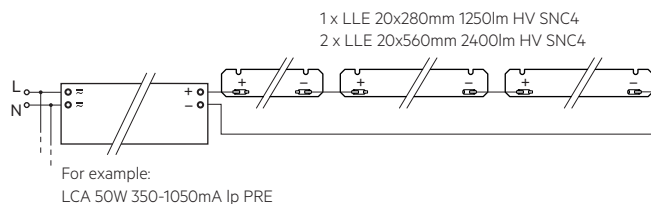
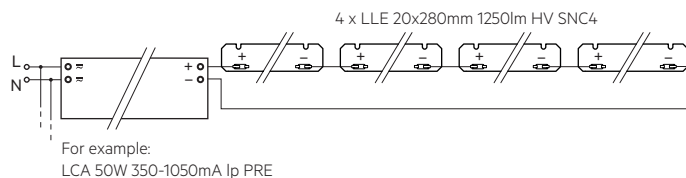

3.3 Wiring type and cross section

For wiring use stranded wire with ferrules or solid wire from 0.2 to 0.75 mm². For the push-wire connection you have to strip the insulation (8–9 mm).

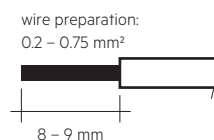

To remove the wires use a suitable tool (e.g. Microcon release pin) or through twist and pull.

3.4 Mounting instruction



None of the components of the LLE (substrate, LED, electronic components etc.) may be exposed to tensile or compressive stresses.

Max. torque for fixing: 0.5 Nm.

The LED modules are mounted onto a heat sink with min. 3 screws per module.

The LLE 20x70mm module is delivered as a board of 280mm (4 pcs.) and must be separated.

Only touch the module at the edge to separate the modules (see marking below).

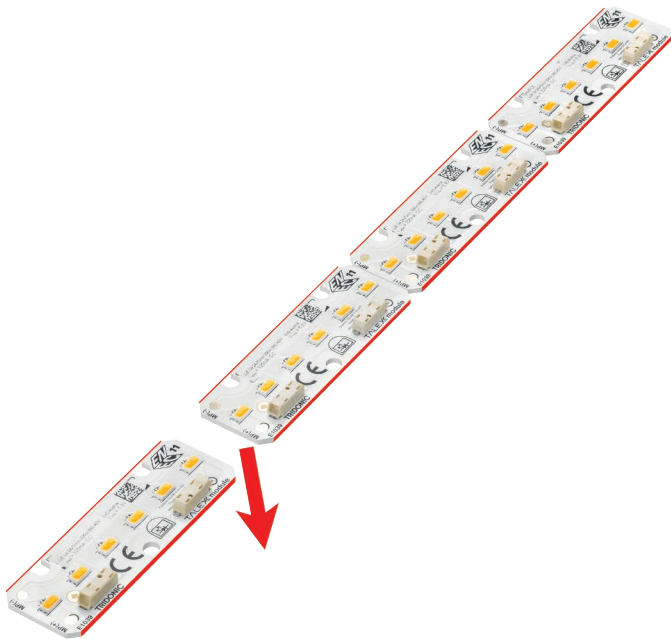

Chemical substance may harm the LED module. Chemical reactions could lead to colour shift, reduced luminous flux or a total failure of the module caused by corrosion of electrical connections.

Materials which are used in LED applications (e.g. sealings, adhesives) must not produce dissolver gas. They must not be condensation curing based, acetate curing based or contain sulfur, chlorine or phthalate.

Avoid corrosive atmosphere during usage and storage.

3.5 EOS/ESD safety guidelines



The device / module contains components that are sensitive to electrostatic discharge and may only be installed in the factory and on site if appropriate EOS/ESD protection measures have been taken. No special measures need be taken for devices/modules with enclosed casings (contact with the pc board not possible), just normal installation practice. Please note the requirements set out in the document EOS / ESD guidelines (Guideline_EOS_ESD.pdf) at: <http://www.tridonic.com/esd-protection>

4. Lifetime

4.1 Lifetime, lumen maintenance and failure rate

The light output of an LED module decreases over the lifetime, this is characterized with the L value.

L70 means that the LED module will give 70 % of its initial luminous flux.

This value is always related to the number of operation hours and therefore defines the lifetime of an LED module.

As the L value is a statistical value and the lumen maintenance may vary over the delivered LED modules.

The B value defines the amount of modules which are below the specific L value, e.g. L70B10 means 10 % of the LED modules are below 70 % of the initial luminous flux, respectively 90 % will be above 70 % of the initial value.

In addition the percentage of failed modules (fatal failure) is characterized by the C value.

4.2 Lumen maintenance for LLE 20mm HV SNC4

Forward current	tp tempera- ture	L90 / B10 L90 / B50 L80 / B10 L80 / B50 L70 / B10 L70 / B50					
		50 °C	>72k h	>72k h	>72k h	>72k h	>72k h
100 mA	60 °C	>72k h	>72k h	>72k h	>72k h	>72k h	>72k h
	85 °C	>72k h	>72k h	>72k h	>72k h	>72k h	>72k h
	50 °C	>72k h	>72k h	>72k h	>72k h	>72k h	>72k h
300 mA	60 °C	>72k h	>72k h	>72k h	>72k h	>72k h	>72k h
	85 °C	>72k h	>72k h	>72k h	>72k h	>72k h	>72k h
	50 °C	42k h	44k h	>72k h	>72k h	>72k h	>72k h
500 mA	60 °C	42k h	44k h	>72k h	>72k h	>72k h	>72k h
	85 °C	42k h	44k h	>72k h	>72k h	>72k h	>72k h

L00C03 >72k h. At tp rated, based on 10 switching cycles per day.

4.3 Switching capability

100,000 cycles

Test according to IEC 62717 CI 10.3.3

30 s on / 30 s off at Imax

5. Electrical values

5.1 Declaration of electrical parameters

Irated ... Nominal operating current the module is designed for.

I_{max} ... Max. permissible continuous operating current incl. The tolerances of the LED driver.

Max. permissible LF current ripple ... Max. output current of the LED driver incl. Tolerances and LF current ripple must not exceed this value.

Max. permissible peak current ... The max. output peak current of the LED driver must not exceed this value.

5.2 Typ. forward voltage vs. forward current

LLE 20x70mm 325lm 8xx HV SNC4 QTY4

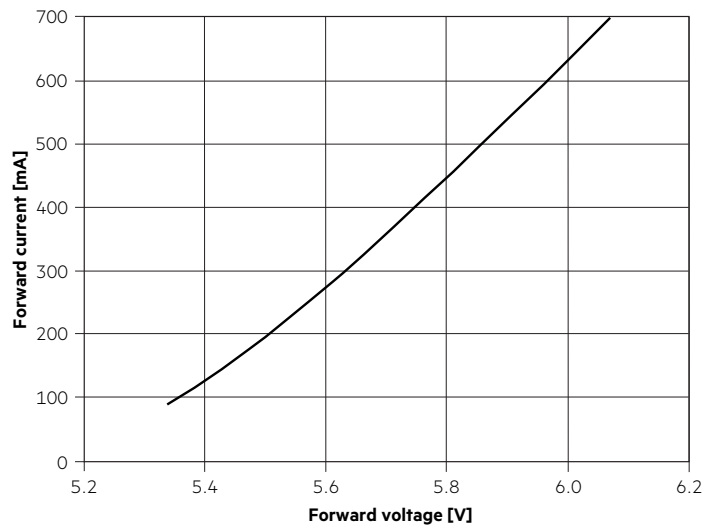

LLE 20x140mm 650lm 8xx HV SNC4

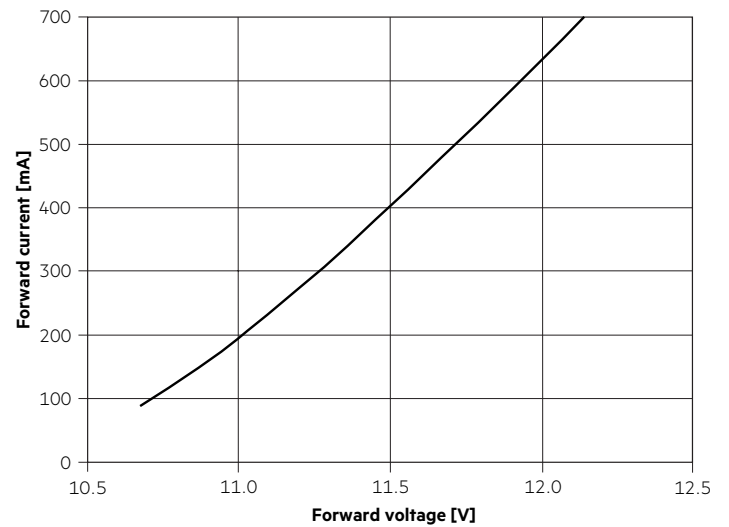

LLE 20x280mm 1250lm 8xx HV SNC4

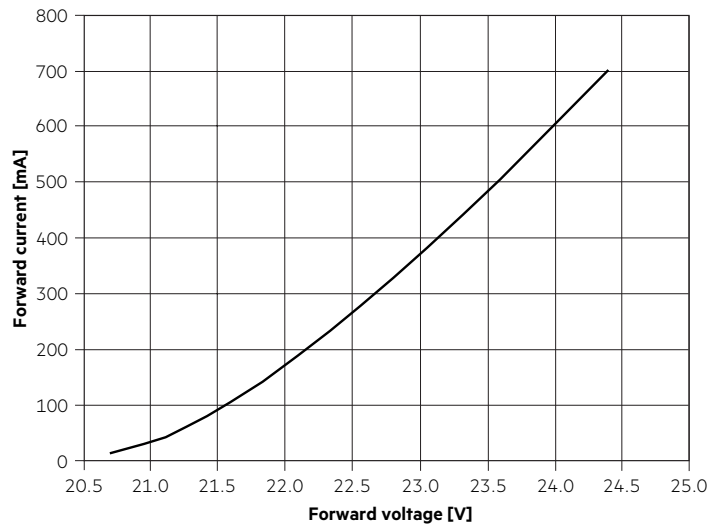

LLE 20x560mm 2400lm 8xx HV SNC4

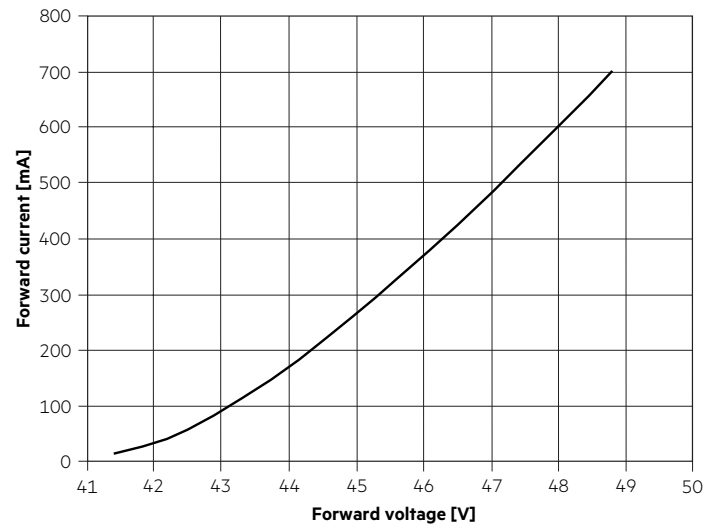

The diagrams are based on statistic values.

The real values can be different.

5.3 Forward voltage vs. tc temperature

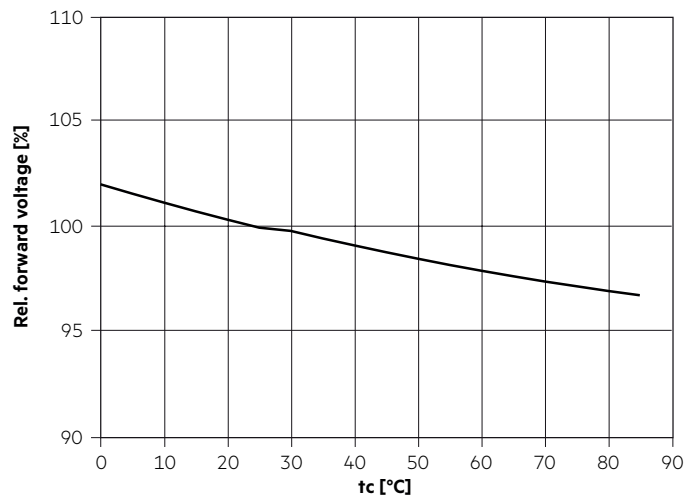

The diagrams are based on statistic values.
The real values can be different.

6. Photometric characteristics

6.1 Coordinates and tolerances according to CIE 1931

The specified colour coordinates are integral measured by current impulse of 450 mA and a duration of 100 ms.
 The ambient temperature of the measurement is $t_a = 25^\circ\text{C}$.
 The measurement tolerance of the colour coordinates are ± 0.01 .

3,000 K

	x0	y0
Centre	0.4338	0.4030

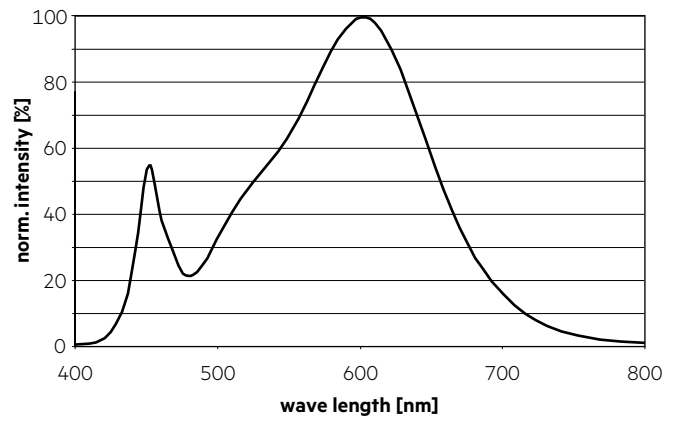
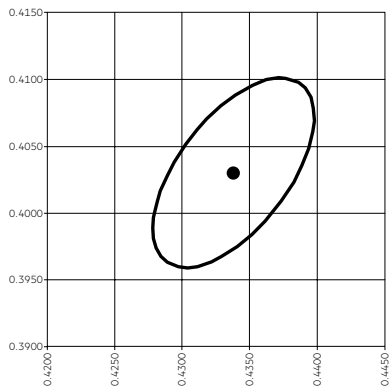

4,000 K

	x0	y0
Center	0.3818	0.3797

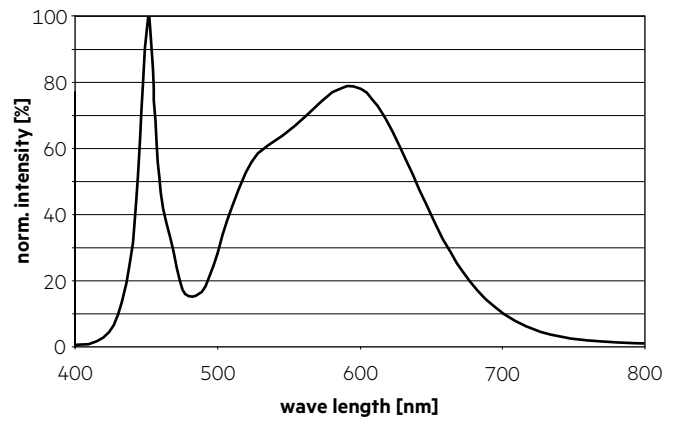
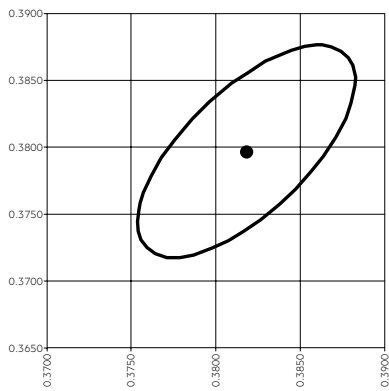

5,000 K

	x0	y0
Center	0.3447	0.3553

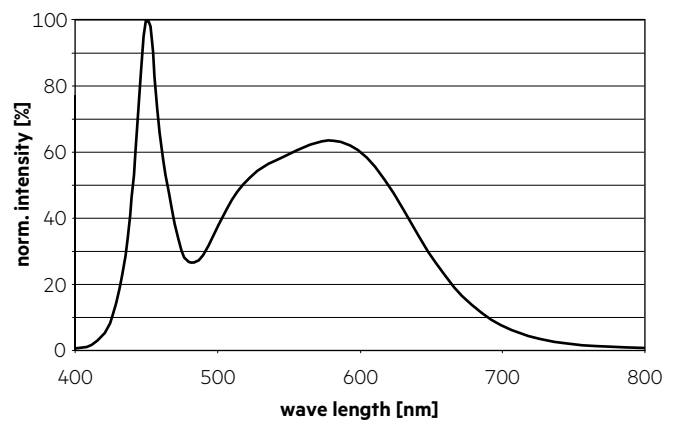
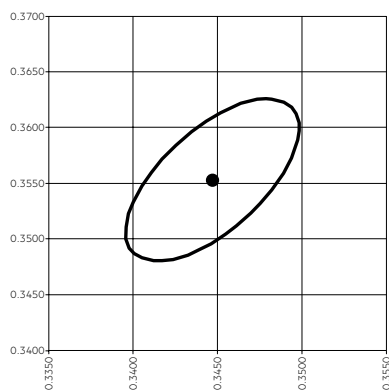

6,500 K

	x0	y0
Center	0.3123	0.3282

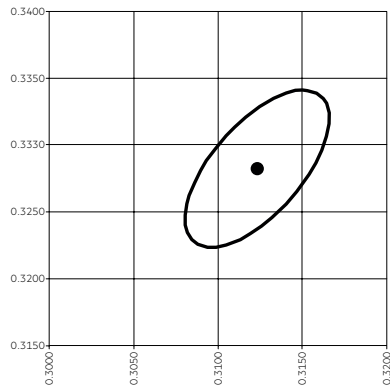

— MacAdam Ellipse: 3SDCM

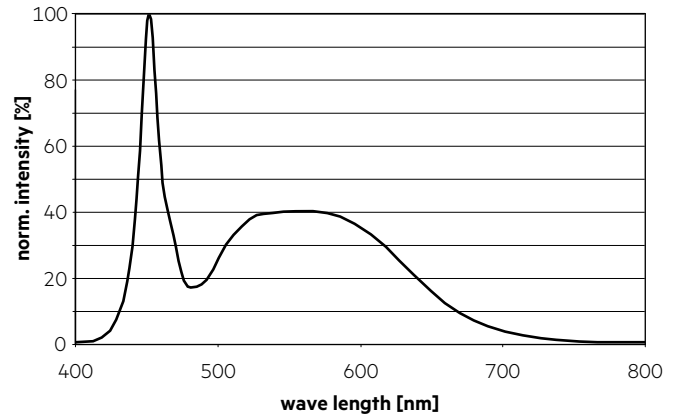

6.2 Light distribution

The optical design of the LLE product line ensures optimum homogeneity for the light distribution.

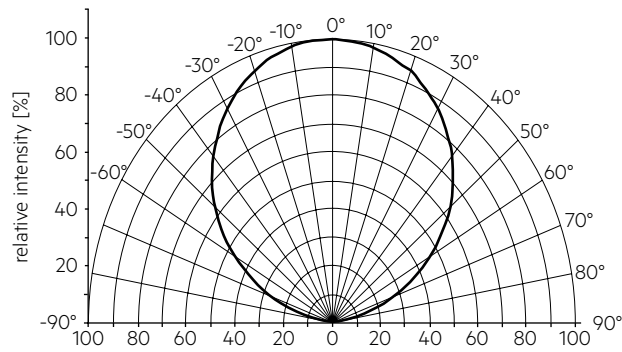

The colour temperature is measured integral over the complete module. The single LED light points can have deviations in the colour coordinates within MacAdam 5. To ensure an ideal mixture of colours and a homogeneous light distribution a suitable optic (e. g. PMMA diffuser) and a sufficient spacing between module and optic (typ. 4 cm) should be used.

6.4 Relative luminous flux vs. operating current

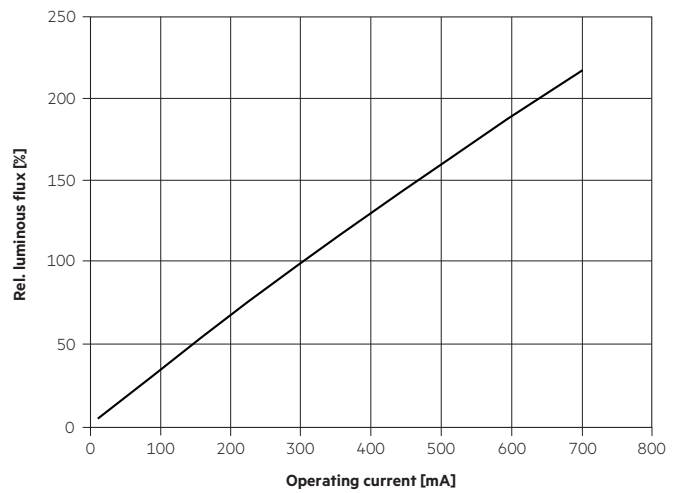

The diagrams are based on statistic values. The real values can be different.

6.3 Relative luminous flux vs. tc temperature

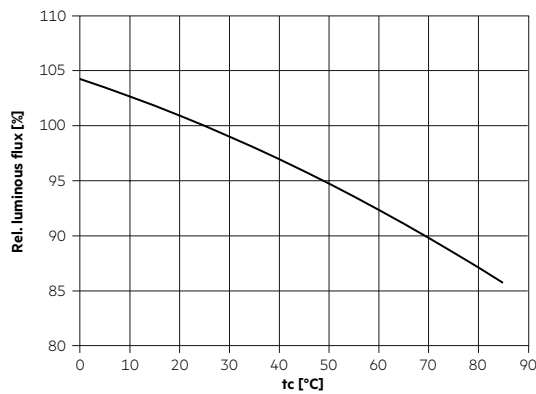

7. Miscellaneous

7.1 Additional information

Additional technical information at www.tridonic.com → Technical Data

Guarantee conditions at www.tridonic.com → Services

Lifetime declarations are informative and represent no warranty claim.