

## DALI-2 RGBW LED Dimmer CC

### Datasheet Control Gear

#### RGBW LED Dimmer (CC, DT8)



- common plus connector
- Art. Nr. 86458912-100 (100mA)
  - Art. Nr. 86458912-250 (250mA)
  - Art. Nr. 86458912-350 (350mA)
  - Art. Nr. 86458912-500 (500mA)
  - Art. Nr. 86458912-700 (700mA)

- common minus connector
- Art. Nr. 86458912-250GM (250mA)
  - Art. Nr. 86458912-350GM (350mA)
  - Art. Nr. 86458912-500GM (500mA)
  - Art. Nr. 86458912-700GM (700mA)

# DALI-2 RGBW LED Dimmer CC Control Gear

## Overview

- DALI LED-Dimmer for RGBW colour control
- Suitable for constant current LED-modules
- **Operating Mode DT8:** one DALI-address for the independent control of level and colour (DALI DT8, Type RGBWAF)
- **Operating Mode Colour&Dim:** control by 2 DALI-addresses, one for adjusting the level and one for adjusting the colour
- **SwitchDim2:** 2 switch-inputs offer control of level and colour without DALI
- dimming range 0.1%-100%
- adjustable PWM-frequency (122Hz/244Hz/488Hz/976Hz from FW version 4.6 on changed PWM frequencies: 122Hz/ 250Hz / 500Hz / 1kHz)
- types with common plus connector for constant currents up to 700mA
- types with common minus connector (GM) for constant currents up to 700mA
- independent electrical device, suitable for integration in luminaires (protection class II) or remote ceiling
- supply voltage 12V to 48V DC
- output voltage up to 45VDC
- integrated short circuit protection
- low standby power consumption
- high efficiency
- configuration via PC-software DALI-Cockpit and DALI interface (e.g. DALI USB)
- user-friendly factory default settings



## Specification, Characteristics

### Common Plus Connector (GP)

type	DALI RGBW 100mA GP	DALI RGBW 250mA GP	DALI RGBW 350mA GP	DALI RGBW 500mA GP	DALI RGBW 700mA GP
article number	86458912-100	86458912-250	86458912-350	86458912-500	86458912-700

input: V+, V-					
input type	supply, DC				
marking terminals	V+, V-				
input voltage range	12V DC ... 48V DC (SELV)				
max. input current $I_{in\_max}$	100mA	250mA	350mA	500mA	700mA

Rated power @12V	1,2W	3W	4,2W	6W	8,4W
rated power @48V	4,8W	12W	16,8W	24W	33,6W
standby power consumption	180mW @12V				
power on behaviour	configurable via DALI: 0%-100% or last value				

**input: DA, DA**

input type	DALI, control signal
marking terminals	DA, DA
input voltage range	9,5V ... 22,5V DC (according to IEC62386-101)
input current	≤ 2mA
number of DALI addresses	operating mode DT8: 1 operating mode Colour&Dim: 2

**Input: N, SW&DIM2-1, SW&DIM2-2**

input type	SwitchDim2 control input
marking terminals	N; SW&DIM2-1 (DA); SW&DIM2-2 (DA)
number of inputs	2
input voltage	230V AC ±10%
input supply frequency	50Hz
control pulse length	short:>40ms, long: > 400ms
input resistance	200kΩ
max. voltage between inputs	230V AC

**output: LED+, R-, G-, B-, W-**

output type	LED Dimmer, constant current PWM				
marking terminals	LED+, R-, G-, B-, W-				
number of outputs	4				
PWM frequency	FW: < 4.6: 122Hz/244Hz/488Hz/976Hz FW: ≥ 4.6: 122Hz/ 250Hz/ 500Hz / 1kHz				
output voltage range $V_{led}$	3V-45V (with 48V supply)				
max. output current per channel $I_{led}$	100mA	250mA	350mA	500mA	700mA
max. output power @45V	4,5W	11,25W	15,75W	22,5	31,5W
overload protection	yes				
open circuit proof	yes				
short circuit proof	yes				

**insulation data**

impulse voltage category	II
pollution degree	2
rated insulation voltage	250V
Rated impulse voltage	4kV
Isolation	
supply <-> output	no insulation
DALI/Sw&Dim2 <-> output/supply	reinforced isolation
DALI/Sw&Dim2 <-> housing	reinforced isolation
insulation test voltage	3000VAC

**environmental conditions**

operational ambient temperature	-20°C ... +60°C
storing and transportation temperature	-20°C ... +75°C
rel. humidity, none condensing	15% ... 90%

**general data**

dimensions (LxWxH)	120mmx42mmx22mm
mounting	remote ceiling, integration in class II devices
rated max. temperature tc	75°C
expected life time @tc	100.000h
housing material	PC, class V0
protection class	II in intended use
protection degree	IP20

**terminals: V+, V-**

connection type	spring terminal connector (cage clamp)
wire size solid core	0,08 ... 2,5 mm <sup>2</sup> (AWG28 ... AWG14)
wire size fine wired	0,08 ... 2,5mm <sup>2</sup> (AWG 28 ... AWG 14)
wire size using wire end ferrule	0,25 ... 1 mm <sup>2</sup>
stripping length	5 ... 6 mm / 0,2 ... 0,24 inch
material	PA66, class V0
release of wire	push back spring with tool

**terminals: DA, DA, N, LED+, R-, G-, B-, W-**

connection type	spring terminal connector (push in cage clamp)
wire size solid core	0,2 ... 1,5 mm <sup>2</sup> (AWG20 ... AWG16)
wire size fine wired	0,2 ... 1,5 mm <sup>2</sup> (AWG20 ... AWG16)
wire size using wire end ferrule	0,25 ... 1 mm <sup>2</sup>
stripping length	8,5 ... 9,5mm / 0,33 ... 0,37inch
material	PA66, class V0
release of wire	push button

**standards**

DALI	EN 62386-101, EN 62386-102, EN 62386-207
EMC	EN 61547 EN 55015 / IEC CISPR15
electrical safety	EN 61347-2-13 EN 61357-1
performance	EN 62384
markings	CE, UKCA, DALI-2

on request: output currents from 100mA to 700mA are available

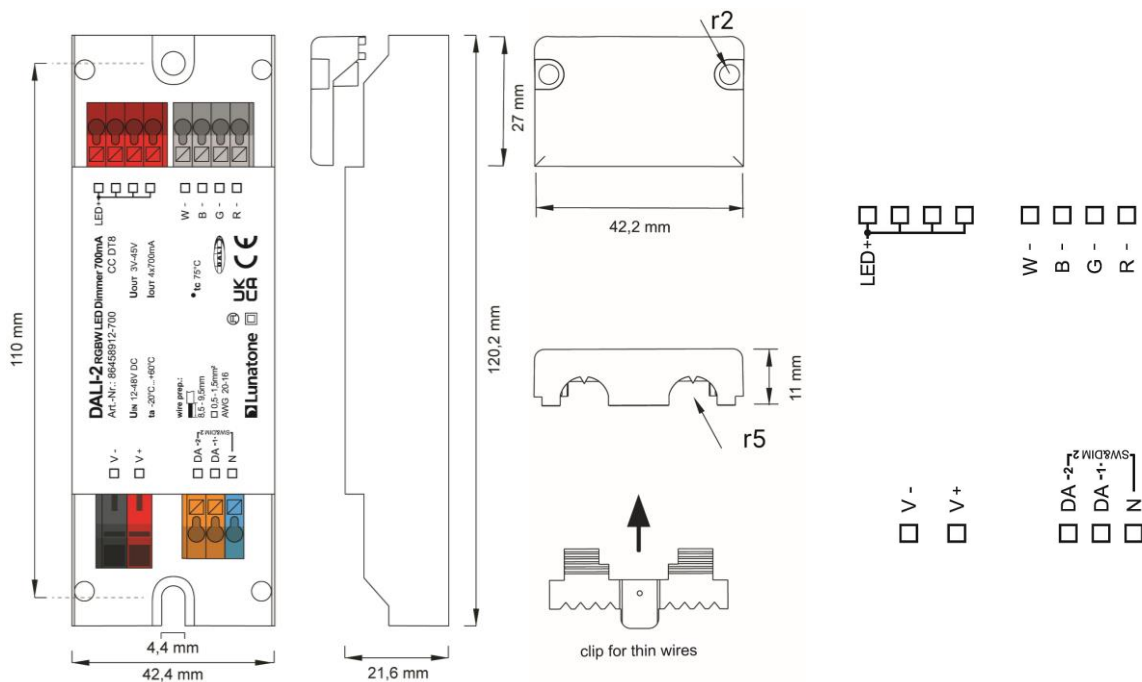

dimensions common plus connector type (GP)

connection plan (GP)

**Common Minus Connector (GM)**

type	DALI RGBW 250mA GM	DALI RGBW 350mA GM	DALI RGBW 500mA GM	DALI RGBW 700mA GM
article number	86458912-250GM	86458912-350GM	86458912-500GM	86458912-700GM

**input: V+, V-**

input type	supply, DC			
marking terminals	V+, V-			
input voltage range	12V DC ... 48V DC (SELV)			
max. input current $I_{in\_max}$	250mA	350mA	500mA	700mA
Rated power @12V	3W	4,2W	6W	8,4W
rated power @48V	12W	16,8W	24W	33,6W
standby power consumption	180mW @12V			
power on behaviour	configurable via DALI: 0%-100% or last value			

**input: DA, DA**

input type	DALI, control signal			
marking terminals	DA, DA			
input voltage range	9,5V ... 22,5V DC (according to IEC62386-101)			
input current	≤ 2mA			
number of DALI-addresses	operating mode DT8: 1 operating mode Colour&Dim: 2			

**Input: N, SW&DIM2-1, SW&DIM2-2**

input type	SwitchDim2 control input			
marking terminals	N; SW&DIM2-1 (DA); SW&DIM2-2 (DA)			
number of inputs	2			

input voltage	230V AC $\pm$ 10%
input supply frequency	50Hz
control pulse length	short:>40ms, long: > 400ms
input resistance	200k $\Omega$
max. voltage between inputs	230V AC

**output: LED-, R+, G+, B+, W+**

output type	LED Dimmer, constant current PWM			
marking terminals	LED-, R+, G+, B+, W+			
number of outputs	4			
PWM frequency	FW: < 4.6: 122Hz/244Hz/488Hz/976Hz FW: $\geq$ 4.6: 122Hz/ 250Hz/ 500Hz / 1kHz			
output voltage range $U_{led}$	3V-45V (with 48V supply)			
max. output current per channel $I_{led}$	250mA	350mA	500mA	700mA
max. output power @45V	11,25W	15,75W	22,5	31,5W
overload protection	yes			
open circuit proof	yes			
short circuit proof	yes			

**insulation data**

impulse voltage category	II			
pollution degree	2			
rated insulation voltage	250V			
rated impulse voltage	4kV			
insulation supply <-> output	no insulation			
DALI/Sw&Dim2 <-> output/supply	reinforced isolation			
DALI/Sw&Dim2 <-> housing	reinforced isolation			
insulation test voltage	3000VAC			

**environmental conditions**

operational ambient temperature	-20°C ... +60°C
storing and transportation temperature	-20°C ... +75°C
rel. humidity, none condensing	15% ... 90%

**general data**

dimensions (LxWxH)	120mmx42mmx22mm
weight per packaging unit	80g
packaging unit	single packing
mounting	remote ceiling, integration in class II devices
rated max. temperature $t_c$	75°C
expected life time @ $t_c$	100.000h
housing material	PC, class V0
protection class	II in intended use
protection degree	IP20

**terminals: V+, V-**

connection type	spring terminal connector (cage clamp)
wire size solid core	0,08 ... 2,5 mm <sup>2</sup> (AWG28 ... AWG14)
wire size fine wired	0,08 ... 2,5mm <sup>2</sup> (AWG 28 ... AWG 14)
wire size using wire end ferrule	0,25 ... 1 mm <sup>2</sup>
stripping length	5 ... 6 mm / 0,2 ... 0,24 inch
material	PA66, class V0
release of wire	push back spring with tool

**terminals: DA, N, LED-, R+, G+, B+, W+**

connection type	spring terminal connector (push in cage clamp)
wire size solid core	0,2 ... 1,5 mm <sup>2</sup> (AWG20 ... AWG16)
wire size fine wired	0,2 ... 1,5 mm <sup>2</sup> (AWG20 ... AWG16)
wire size using wire end ferrule	0,25 ... 1 mm <sup>2</sup>
stripping length	8,5 ... 9,5mm / 0,33 ... 0,37inch
material	PA66, class V0
release of wire	push button

**standards**

DALI	EN 62386-101, EN 62386-102, EN 62386-207
EMC	EN 61547 EN 55015 / IEC CISPR15
electrical safety	EN 61347-2-13 EN 61357-1
performance	EN 62384
markings	CE, UKCA, DALI-2

on request: output currents from 100mA to 700mA available

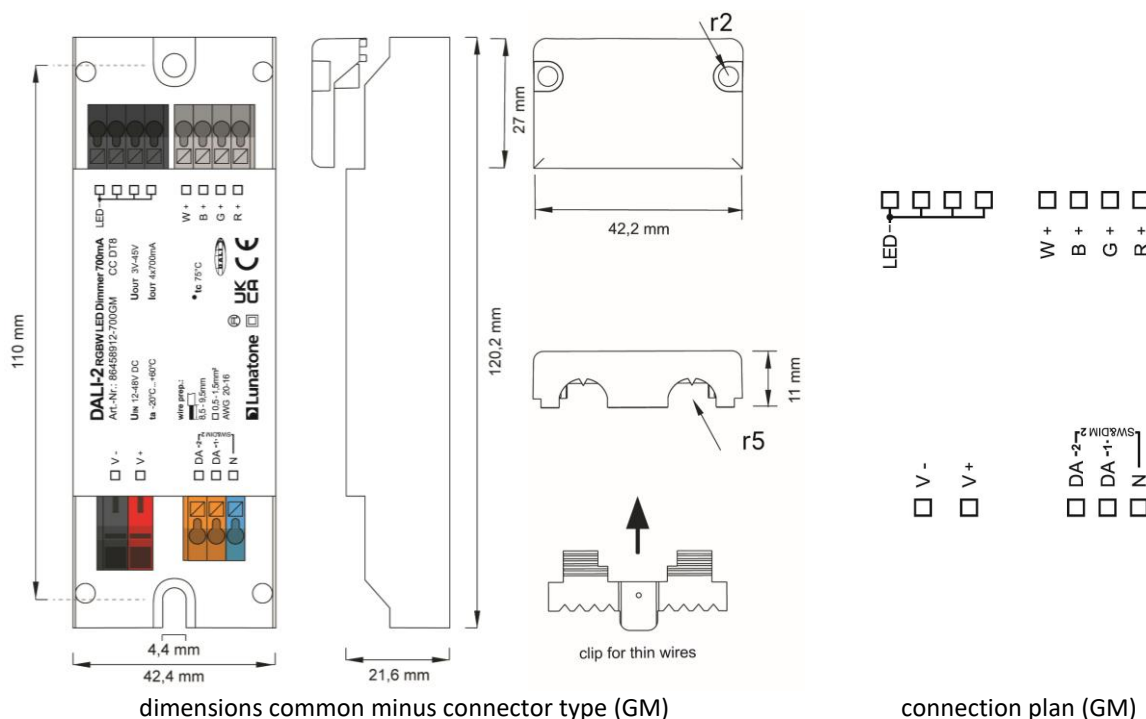

dimensions common minus connector type (GM)

connection plan (GM)

## Installation

- The DALI RGBW LED Dimmer is an independent device and is intended for remote ceiling installation or in an enclosure. Ensure proper cable relief for installation in protection class II devices
- The wiring should be carried out as a permanent installation in a dry and clean environment.
- Installation may only be carried out in a voltage-free state of the system and by qualified specialists.
- National regulations for setting up electrical systems must be followed.
- Connect terminals V + and V- to a DC voltage supply of the SELV category (Safety Extra Low Voltage) according to their label.
- The connection to the DALI line (terminals DA, DA) can be made regardless of polarity.
- For alternative use as Sw&Dim inputs, the same phase must be used for both inputs.
- The DALI bus input is protected against overvoltage (mains voltage) - this protects the component from being destroyed in the event of incorrect wiring

- Wiring topology of the DALI-line: line, tree, star
- Connect only one wire on each terminal, if twin ferrules are used take care to the maximum wire size
- The DALI wiring can be realised with standard low-voltage installation material. No special cables are required.
- The DALI line may be routed together with the mains voltage (in one cable or as single wires in a tube)



**Attention:** The DALI-signal is not classified as SELV circuit (Safety Extra Low Voltage). Therefore, the installation regulations for low voltage apply



The voltage drop on the DALI line must not exceed 2V at maximum length (300m) and maximum bus load (250mA).



**Hint:**

For highest efficiency the input voltage should range between 3V and 10V above the LED-voltage:

- 4-6 LEDs: 24V
- 6-9LEDs: 36V
- 10-12 LEDs: 48V

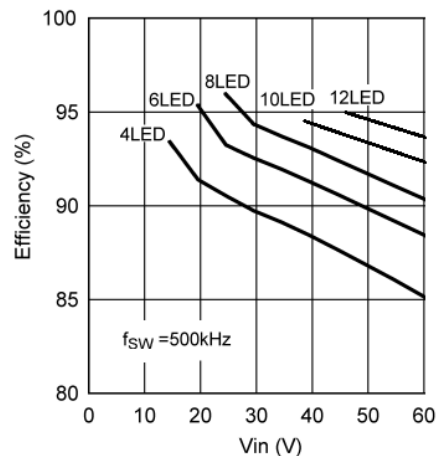

## Application Example

### Control via DALI

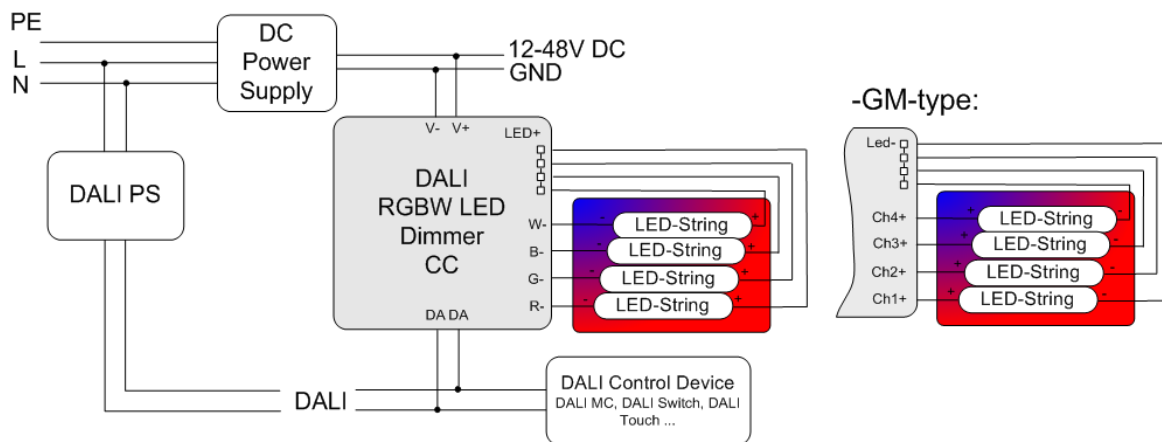

### Control via SwitchDim2

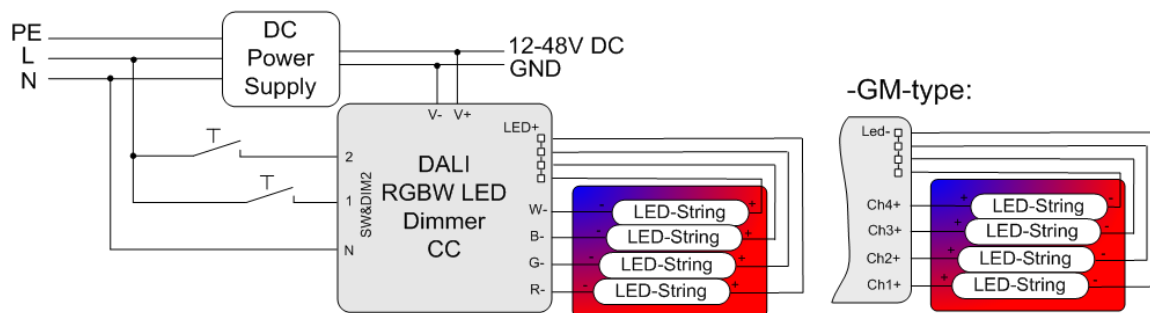

## Commissioning

- After connection the RGBW Dimmer is ready to use. Delivery default settings see page 15
- The RGBW Dimmer can be addressed with the DALI Cockpit PC Software. When using the [DALI Cockpit Software](#), the PC must be connected to the DALI bus via a suitable interface module ([DALI-2 USB](#); [DALI USB](#), [DALI-2 WLAN](#), [DALI-2 Display](#), [DALI-2 IoT](#), [DALI 4Net](#), [DALI SCI RS232](#)). The DALI Dimmer is automatically recognised by the DALI Cockpit during the addressing process and listed in the device overview.
- Scene values, groups, DALI parameters and device specific settings can be configured in the DALI Cockpit, see section DALI Cockpit: General Settings page 10 and following.

## Operating Modes

The device offers several operating modes:

### DT8 (factory default)

In this operating mode one DALI-address for the independent control of light level and colour is used (Device Type 8 RGBWAF). From FW version 4.6 on Lunatone LED Dimmer are DALI 2 compatible and support DALI 2 commands.

**SwitchDim2:** alternatively, the device can be controlled using 2 switch-inputs for mains voltage (SwitchDim2):

SW&DIM2-1: light level

short press: On/Off

long press: dimming

SW&DIM2-2: colour

long press: change colour

### Colour&Dim

This operating mode is suitable for operating RGB—luminaires. Two DALI-addresses are used, the first to control the light level and the second for changing the distribution on the output channels (e.g. for colour adjustments).

The Colour&Dim mode allows colour adjustments without affecting the level and vice versa. For each channel only DALI-standard commands like dim up/down but also DAP are used. Thus the device can be used with all common controls and gateways (e.g. KNX). The Colour&Dim mode provides an alternative to the DT8-RGBWAF mode.

### Can be operated via DALI or SwitchDim2:

DALI-address 1, SW&DIM2-1: light level

DALI-address 2, SW&DIM2-2: colour

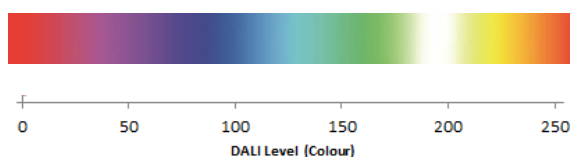

### Selection of operating mode

With the help of the PC-software tool DALI-Cockpit the operating mode can be easily set on the general settings page.

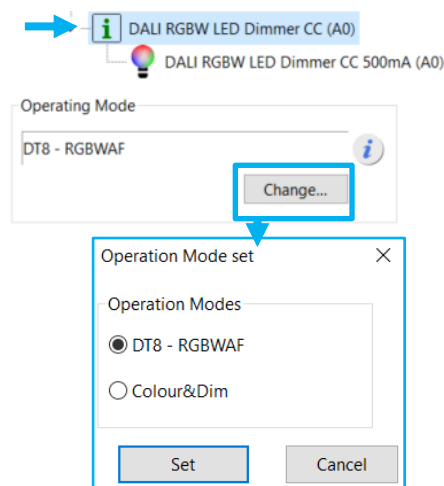

Switching between operating modes can also be done with the help of the DALI-command SET OPERATING MODE (IEC 62386-102 Ed.2). When changing the operating mode the number of used DALI-addresses can change as well and this requires a new addressing procedure. In the DALI-Cockpit this address assignment is performed automatically.

Operating Mode:

number	operating mode
0x0	DT8 (factory default)
0x92	DT8
0x93	Colour&Dim

### DALI Cockpit: General Settings

On the overview page respective control elements are available for each operating mode

- DT8: 3 sliders, one for level and one for colour, one for white
- Colour&Dim: 2 sliders, one for level and one for colour

Additionally the following configurations can be made:

**PWM Frequency**

The PWM frequency can be selected:  
122Hz / 244Hz / 488Hz / 976Hz.

From FW version 4.6 changed PWM frequencies: 122Hz/ 250Hz / 500Hz / 1kHz.

**Ignore Broadcast Commands**

The broadcast control of each channel can be deactivated individually. Through selection of “Ignore Broadcast”, the respective channel does no longer respond to broadcast commands on the DALI bus (group assignments are not ignored).

**Adjustable RESET behaviour**

From FW 4.6. on the response to a DALI reset command is configurable. The following options are available:

- *Ignore command*: the DALI reset command does not trigger any changes to the device settings.
- *DALI standard*: the selected device settings are reset to the values defined in

the DALI standard (see table 1 below - second column: DALI standard values)

- *Custom settings*: the current device settings can be saved. With a DALI Reset command, the selected parameters (6 check boxes) are then reset to these saved values.

**Calibration - light adjustment**

The dimming range reaches from 0.1% to 100%. From FW version 4.6 on, it is possible to calibrate different light sources, with the option: “LED Calibration”.

For each channel, the MIN level (default: 0.1%) an intermediate value (default: 33%) and the MAX level (default: 100%) can be adjusted and matched between light sources.

To do this, the desired level with the upper slider needs to be set. Apply the value and start the fine adjustment by pressing the button next to it. The appropriate fine adjustments can now be made with the calibration slider below. See also Figure 1

Overview page operating mode DT8

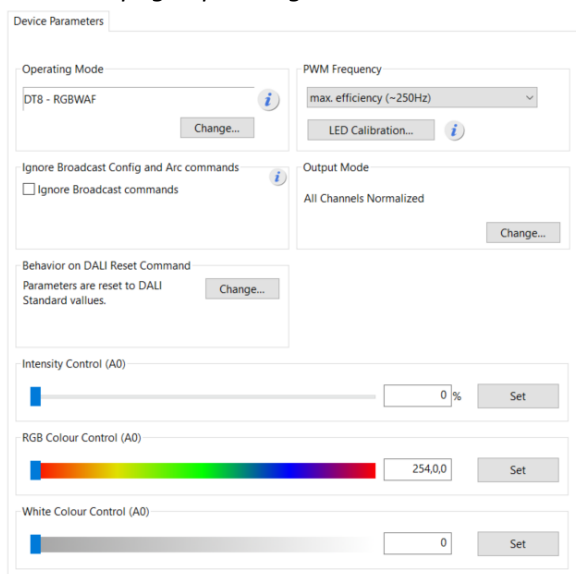

Overview page operating mode Colour&Dim

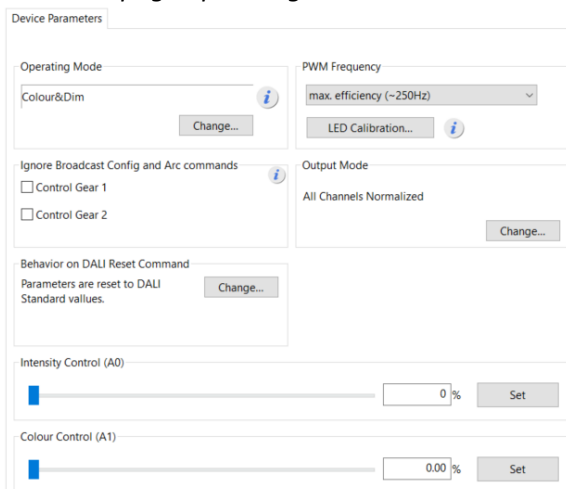

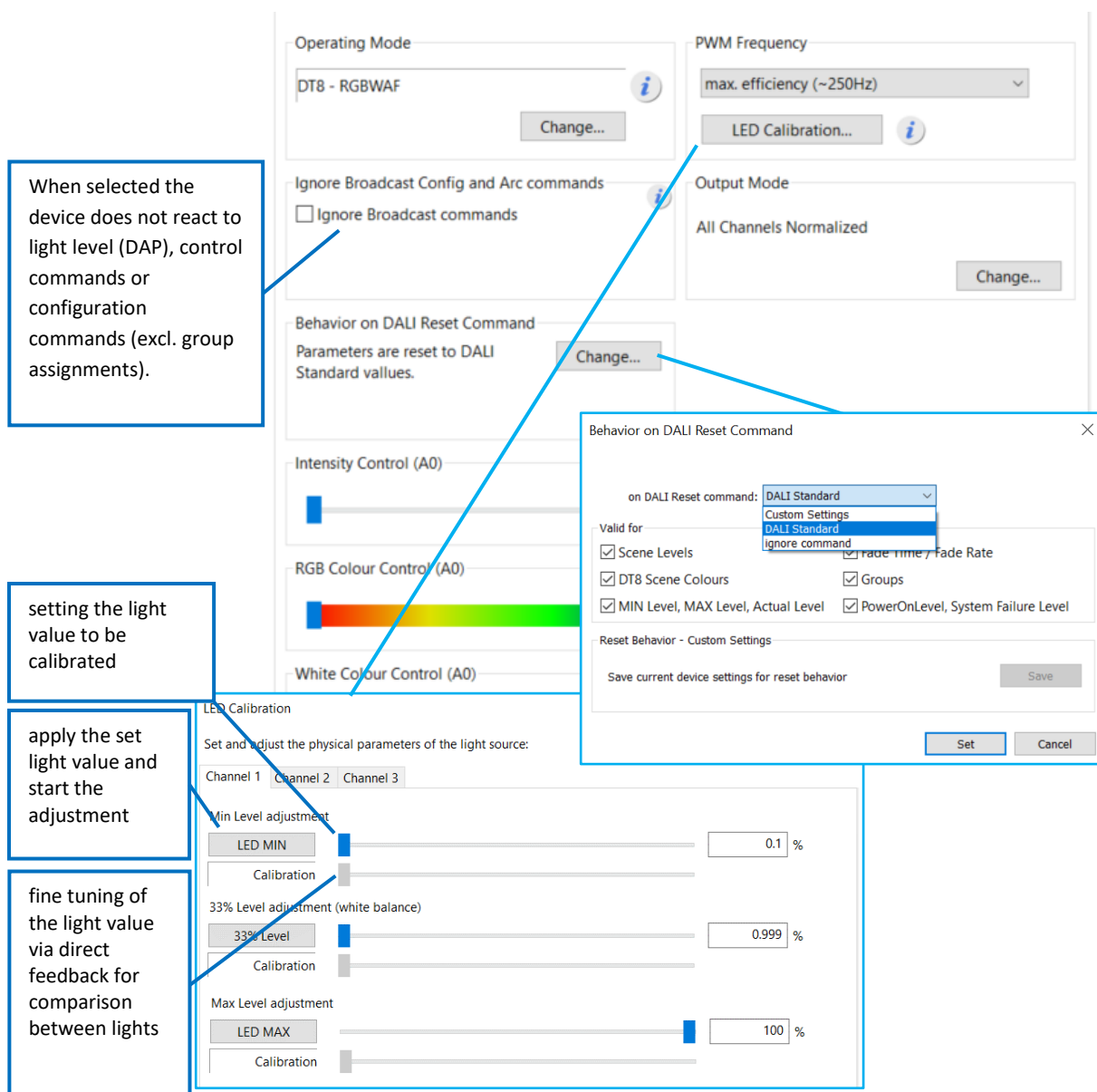

Figure 1 Cockpit overview page – LED calibration and settable RESET behaviour

## DALI Cockpit: Additional Settings

Besides the settings on the general page each channel can be selected separately in the component tree for individual configuration.



For each address the group membership can be set as well as scene values and DALI-parameters. In Colour&Dim operating mode, all values assigned to channel 2 are representing colours.

Figure 2 on page 14 shows the settings for for operating mode DT8.

Figure 3 on page 14 shows the settings for each channel for operating mode Colour&Dim.

**Scene settings**

Via the arrow button the scene settings can be imported and exported.

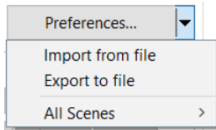

Via the button „Preferences“ the default scene settings can be loaded.

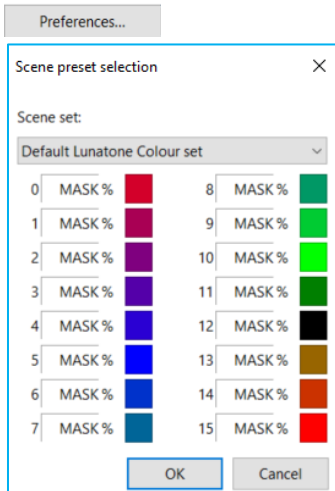

From FW 6.0 on, extended scene settings can be configured. With extended scenes it is possible to automatically change between 2 scene values (once or looped). Thereby enabling configuration of blinking lights, time delayed switch off or light repetitions, as well as traveling lights with multiple dimmers.

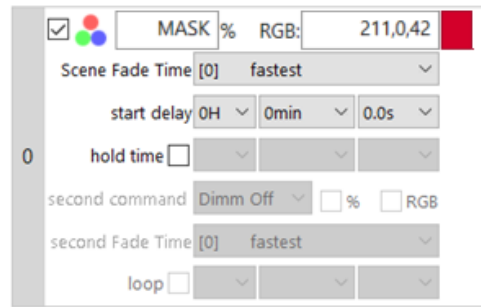
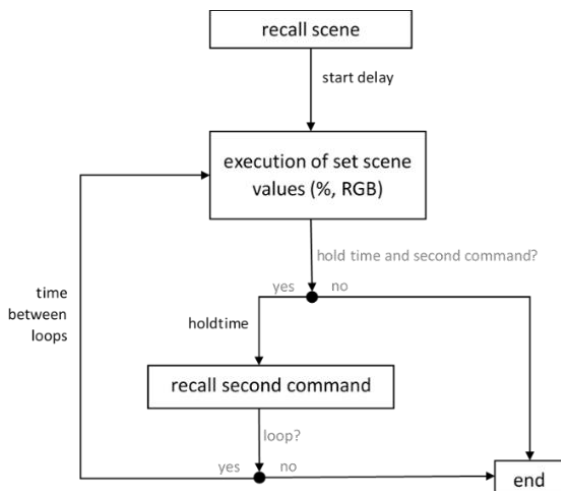

Extended Scenes are available for each of the 16 scenes on the second tab:

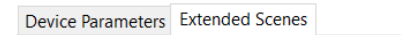

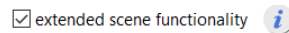

By enabling the extended scenes these are used instead of the standard scenes on the "Device Parameters" tab

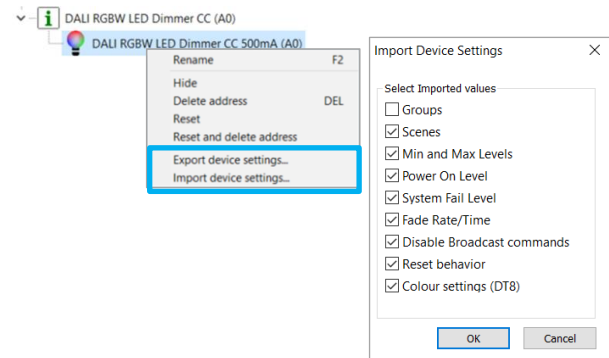

**Import/Export settings**

With a right click on the channel in the device-tree overview the device settings can be exported or imported.





Actual Level: 0%

ON (MAX) OFF

MIN

Set Act Level

0 %

Set

Set Colour

RGB 254,0,0

W 0

Set

Device Info	
Name DALI RGBW LED Dimme...	Article Number 86458912-500 GTIN
Manufacturer Lunatone	Serial Number 103 FW 5.2.70
Device Type 8	Type Control Gear
DALI Ver V2.0	Short Address (A0) DALI RGBW LED Dimmer CC Set

Device Parameters	
Groups	
0 1 2 3 4 5 6 7 8 9 10 11 12 13 14 15	
DALI Parameter	
MIN Level:	0.1 %
MAX Level:	100 %
Power On Level:	100 %
Power On Colour: RGB: MASK W: MASK	
System Fail Level:	100 %
System Fail Color: RGB: MASK W: MASK	
Fade time	ext fade s
Ext Fade Time	fastest
Fade rate	44.7 step/s
Scenes	
Preferences...	
0 <input checked="" type="checkbox"/> MASK % RGB: 211,0,42 W: 0	8 <input checked="" type="checkbox"/> MASK % RGB: 0,152,101 W: 0
1 <input checked="" type="checkbox"/> MASK % RGB: 169,0,84 W: 0	9 <input checked="" type="checkbox"/> MASK % RGB: 0,203,50 W: 0
2 <input checked="" type="checkbox"/> MASK % RGB: 127,0,127 W: 0	10 <input checked="" type="checkbox"/> MASK % RGB: 0,254,0 W: 0
3 <input checked="" type="checkbox"/> MASK % RGB: 84,0,169 W: 0	11 <input checked="" type="checkbox"/> MASK % RGB: 0,127,0 W: 127
4 <input checked="" type="checkbox"/> MASK % RGB: 42,0,211 W: 0	12 <input checked="" type="checkbox"/> MASK % RGB: 0,0,0 W: 254
5 <input checked="" type="checkbox"/> MASK % RGB: 0,0,254 W: 0	13 <input checked="" type="checkbox"/> MASK % RGB: 152,101,0 W: 0
6 <input checked="" type="checkbox"/> MASK % RGB: 0,50,203 W: 0	14 <input checked="" type="checkbox"/> MASK % RGB: 203,50,0 W: 0
7 <input checked="" type="checkbox"/> MASK % RGB: 0,101,152 W: 0	15 <input checked="" type="checkbox"/> MASK % RGB: 254,0,0 W: 0

Figure 2 Cockpit settings for DT8



Actual Level: 0%

ON (MAX) OFF

MIN

Set Act Level

0 %

Set

Device Info	
Name DALI RGBW LED Dimme...	Article Number 86458912-500 GTIN
Manufacturer Lunatone	Serial Number 103 FW 5.2.70
Device Type 6	Type Control Gear
DALI Ver V2.0	Short Address (A0) DALI RGBW LED Dimmer CC Set

Device Parameters			
Groups			
0 1 2 3 4 5 6 7 8 9 10 11 12 13 14 15			
DALI Parameter			
MIN Level:	0.1 %		
MAX Level:	100 %		
Power On Level:	100 %		
System Fail Level:	100 %		
Fade time	ext fade s		
Ext Fade Time	fastest		
Fade rate	44.7 step/s		
Scenes			
Preferences...			
0 <input checked="" type="checkbox"/> 100 %	4 <input checked="" type="checkbox"/> 0 %	8 <input checked="" type="checkbox"/> 100 %	12 <input checked="" type="checkbox"/> 100 %
1 <input checked="" type="checkbox"/> 0 %	5 <input checked="" type="checkbox"/> 0 %	9 <input checked="" type="checkbox"/> 0 %	13 <input checked="" type="checkbox"/> 0 %
2 <input checked="" type="checkbox"/> 0 %	6 <input checked="" type="checkbox"/> 100 %	10 <input checked="" type="checkbox"/> 100 %	14 <input checked="" type="checkbox"/> 100 %
3 <input checked="" type="checkbox"/> 0 %	7 <input checked="" type="checkbox"/> 100 %	11 <input checked="" type="checkbox"/> 100 %	15 <input checked="" type="checkbox"/> 0 %

Figure 3 Cockpit settings for each channel – Colour&Dim

## Factory Default Settings

Before the initial addressing is performed, the device can already be controlled by a group address. This predefined grouping will be deleted during the first addressing procedure. Afterwards groups can be assigned as usual (e.g. with the help of the DALI-Cockpit).

By sending a DALI-Reset command the device is set to the DALI default values as defined in the standard.

The factory default values as well as the DALI-norm values are summarised in *Table 1* below.

*Table 1 factory default settings column 1, DALI Standard settings column 2*

	<b>Delivery default</b>	<b>DALI norm</b>																																																																																					
<b>Operating mode</b>	DT8	N/A (remains unchanged)																																																																																					
<b>SwitchDim2</b>	SW&DIM2-1: light level SW&DIM2-2: colour	N/A (remains unchanged)																																																																																					
<b>Min Level</b>	0.1%	0.1%																																																																																					
<b>Max Level</b>	100%	100%																																																																																					
<b>PowerOn Level</b>	Last light level (= MASK)	100%																																																																																					
<b>System Failure Level</b>	100%	100%																																																																																					
<b>Fade Time</b>	1s [2]	none																																																																																					
<b>Fade Rate</b>	89.4 steps/s [5]	44.7 steps/s																																																																																					
<b>PWM-Frequency</b>	FW ≥ 4.6: 1kHz FW < 4.6: 122Hz	N/A (remains unchanged)																																																																																					
<b>Control before initial addressing</b>	G0 (or G0 and G1 in operating mode Colour&Dim)	None																																																																																					
<b>Scene values</b>	<table border="1"> <thead> <tr> <th></th> <th></th> <th></th> <th>RGB</th> <th>White</th> </tr> </thead> <tbody> <tr><td><input checked="" type="checkbox"/> 0</td><td>MASK</td><td>%</td><td>211,0,42</td><td>0</td></tr> <tr><td><input checked="" type="checkbox"/> 1</td><td>MASK</td><td>%</td><td>169,0,84</td><td>0</td></tr> <tr><td><input checked="" type="checkbox"/> 2</td><td>MASK</td><td>%</td><td>127,0,127</td><td>0</td></tr> <tr><td><input checked="" type="checkbox"/> 3</td><td>MASK</td><td>%</td><td>84,0,169</td><td>0</td></tr> <tr><td><input checked="" type="checkbox"/> 4</td><td>MASK</td><td>%</td><td>42,0,211</td><td>0</td></tr> <tr><td><input checked="" type="checkbox"/> 5</td><td>MASK</td><td>%</td><td>0,0,254</td><td>0</td></tr> <tr><td><input checked="" type="checkbox"/> 6</td><td>MASK</td><td>%</td><td>0,50,203</td><td>0</td></tr> <tr><td><input checked="" type="checkbox"/> 7</td><td>MASK</td><td>%</td><td>0,101,152</td><td>0</td></tr> <tr><td><input checked="" type="checkbox"/> 8</td><td>MASK</td><td>%</td><td>0,152,101</td><td>0</td></tr> <tr><td><input checked="" type="checkbox"/> 9</td><td>MASK</td><td>%</td><td>0,203,50</td><td>0</td></tr> <tr><td><input checked="" type="checkbox"/> 10</td><td>MASK</td><td>%</td><td>0,254,0</td><td>0</td></tr> <tr><td><input checked="" type="checkbox"/> 11</td><td>MASK</td><td>%</td><td>0,127,0</td><td>127</td></tr> <tr><td><input checked="" type="checkbox"/> 12</td><td>MASK</td><td>%</td><td>0,0,0</td><td>254</td></tr> <tr><td><input checked="" type="checkbox"/> 13</td><td>MASK</td><td>%</td><td>152,101,0</td><td>0</td></tr> <tr><td><input checked="" type="checkbox"/> 14</td><td>MASK</td><td>%</td><td>203,50,0</td><td>0</td></tr> <tr><td><input checked="" type="checkbox"/> 15</td><td>MASK</td><td>%</td><td>254,0,0</td><td>0</td></tr> </tbody> </table>				RGB	White	<input checked="" type="checkbox"/> 0	MASK	%	211,0,42	0	<input checked="" type="checkbox"/> 1	MASK	%	169,0,84	0	<input checked="" type="checkbox"/> 2	MASK	%	127,0,127	0	<input checked="" type="checkbox"/> 3	MASK	%	84,0,169	0	<input checked="" type="checkbox"/> 4	MASK	%	42,0,211	0	<input checked="" type="checkbox"/> 5	MASK	%	0,0,254	0	<input checked="" type="checkbox"/> 6	MASK	%	0,50,203	0	<input checked="" type="checkbox"/> 7	MASK	%	0,101,152	0	<input checked="" type="checkbox"/> 8	MASK	%	0,152,101	0	<input checked="" type="checkbox"/> 9	MASK	%	0,203,50	0	<input checked="" type="checkbox"/> 10	MASK	%	0,254,0	0	<input checked="" type="checkbox"/> 11	MASK	%	0,127,0	127	<input checked="" type="checkbox"/> 12	MASK	%	0,0,0	254	<input checked="" type="checkbox"/> 13	MASK	%	152,101,0	0	<input checked="" type="checkbox"/> 14	MASK	%	203,50,0	0	<input checked="" type="checkbox"/> 15	MASK	%	254,0,0	0	All scene values MASK
			RGB	White																																																																																			
<input checked="" type="checkbox"/> 0	MASK	%	211,0,42	0																																																																																			
<input checked="" type="checkbox"/> 1	MASK	%	169,0,84	0																																																																																			
<input checked="" type="checkbox"/> 2	MASK	%	127,0,127	0																																																																																			
<input checked="" type="checkbox"/> 3	MASK	%	84,0,169	0																																																																																			
<input checked="" type="checkbox"/> 4	MASK	%	42,0,211	0																																																																																			
<input checked="" type="checkbox"/> 5	MASK	%	0,0,254	0																																																																																			
<input checked="" type="checkbox"/> 6	MASK	%	0,50,203	0																																																																																			
<input checked="" type="checkbox"/> 7	MASK	%	0,101,152	0																																																																																			
<input checked="" type="checkbox"/> 8	MASK	%	0,152,101	0																																																																																			
<input checked="" type="checkbox"/> 9	MASK	%	0,203,50	0																																																																																			
<input checked="" type="checkbox"/> 10	MASK	%	0,254,0	0																																																																																			
<input checked="" type="checkbox"/> 11	MASK	%	0,127,0	127																																																																																			
<input checked="" type="checkbox"/> 12	MASK	%	0,0,0	254																																																																																			
<input checked="" type="checkbox"/> 13	MASK	%	152,101,0	0																																																																																			
<input checked="" type="checkbox"/> 14	MASK	%	203,50,0	0																																																																																			
<input checked="" type="checkbox"/> 15	MASK	%	254,0,0	0																																																																																			
<b>Behaviour on DALI RESET command</b>	set DALI Standard values, see column 2	N/A (remains unchanged)																																																																																					

## Purchase Order Information

**Art.Nr. 86458912-xxx:**

DALI RGBW LED Dimmer CC  
constant current xxx mA -100mA-700mA,  
**common plus connector**,  
supply 12V-48V DC,  
output voltage 3V-45V DC,  
**SwitchDim2**,  
remote ceiling & integration in luminaires

**Art.Nr. 86458912-xxxGM:**

DALI RGBW LED Dimmer CC  
constant current xxx mA - 100mA-700mA,  
**common minus connector**,  
supply 12V-48V DC,  
output voltage 3V-45V DC,  
**SwitchDim2**,  
remote ceiling & integration in luminaires

## Additional Information and Equipment

Lunatone datasheets and manuals  
<https://www.lunatone.com/en/downloads-a-z/>

Lunatone DALI products  
<https://www.lunatone.com/en/>

DALI-Cockpit – DALI system configuration tool,  
free when using a Lunatone interface device  
<https://www.lunatone.com/en/product/dali-cockpit/>

## Contact

Technical Support: [support@lunatone.com](mailto:support@lunatone.com)

Requests: [sales@lunatone.com](mailto:sales@lunatone.com)

[www.lunatone.com](http://www.lunatone.com)



## Disclaimer

Subject to change. Information provided without guarantee.  
The datasheet refers to the current delivery.

The compatibility with other devices must be tested in advance  
to the installation.