



CLIC SPOT F41 CORE11 / CLIC SPOT F41 CORE11

PRODUCT CODE / CODICE PRODOTTO

F41/B5-B-0-C

DESCRIPTION / DESCRIZIONE

48V spot. For 9600C CORE11 tracks. Aluminum body. PMMA Lens 24°. Ø41x176mm.

48V spot. For 9600C CORE11 tracks. Aluminum body. PMMA Lens 24°. Ø41x176mm.

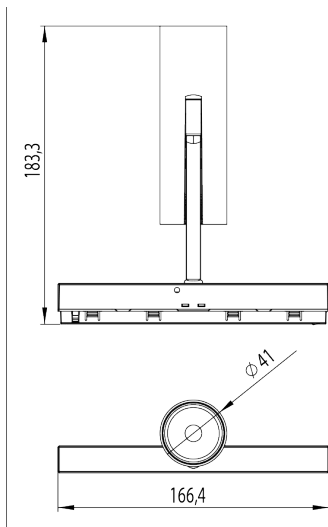

TECHNICAL DATA / DATI TECNICI

Application ON TRACK

Real Flux(lm) 733.14

Nominal Flux(lm) 950.6

Real Power(W) 9.1

Efficiency(lm / W) 80.6

LED source LED

Colour Temperature(K) 3000

CRI 90

MacAdam ≤ 3

Beam Angle 22,8°

UGR

≤ 16	X=4H Y=8H S=0.25H	
	Reflection factors:	70/50/20
	UGR transversal:	14.4
	UGR axial:	14.7

Lifetime(Khr) >60Khr L85B5

Driver ON-OFF

VF ~ 35

I LED(mA) 250

L(mm) 0

Weight(g) 212

Materials Aluminium body + PMMA lens + polycarbonate antiglare

Colour Nero

Mounting Mechanical

Packaging Cardboard box

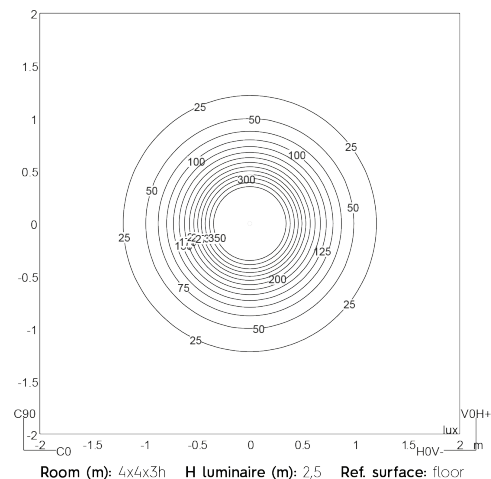
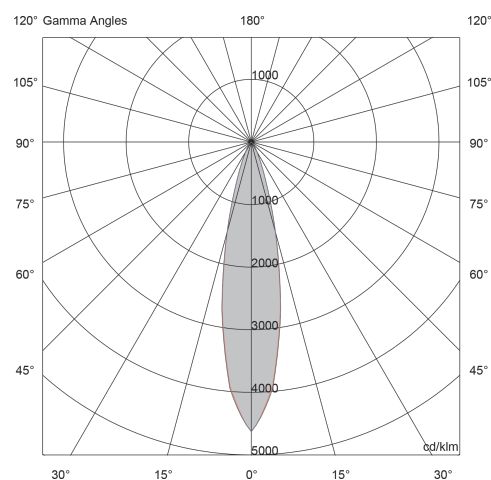

Certifications / Certificazioni



Technical info / Info tecniche



Other colour temperatures and CRI available upon request. All values marked with an (*) are rated values. Unless stated otherwise, the values apply to an ambient temperature of 25°C.

Luminous flux is subject to a normal technology drop over time. A.A.G. Stucchi reserves the right to make technical changes without prior notice. Real power: ±10% tolerance

Other colour temperatures and CRI available upon request. All values marked with an (*) are rated values. Unless stated otherwise, the values apply to an ambient temperature of 25°C.

Luminous flux is subject to a normal technology drop over time. A.A.G. Stucchi reserves the right to make technical changes without prior notice. Real power: ±10% tolerance



CLIC SPOT F41 CORE11 / CLIC SPOT F41 CORE11

PRODUCT CODE / CODICE PRODOTTO

F41/B5-B-2-C

DESCRIPTION / DESCRIZIONE

48V spot. For 9600C CORE11 tracks. Aluminum body. PMMA Lens 24°. Ø41x176mm.

48V spot. For 9600C CORE11 tracks. Aluminum body. PMMA Lens 24°. Ø41x176mm.

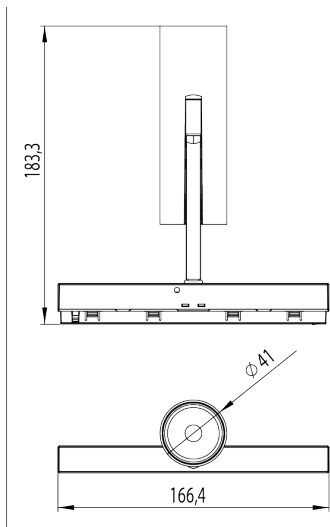

TECHNICAL DATA / DATI TECNICI

Application ON TRACK

Real Flux(lm) 733.14

Nominal Flux(lm) 950.6

Real Power(W) 9.1

Efficiency(lm / W) 80.6

LED source LED

Colour Temperature(K) 3000

CRI 90

MacAdam ≤ 3

Beam Angle 22,8°

UGR

≤ 16	X=4H Y=8H S=0.25H	
	Reflection factors:	70/50/20
	UGR transversal:	14.4
	UGR axial:	14.7

Lifetime(Khr) >60Khr L85B5

Driver DALI 2

VF ~ 35

I LED(mA) 250

L(mm) 0

Weight(g) 218

Materials Aluminium body + PMMA lens + polycarbonate antiglare

Colour Nero

Mounting Mechanical

Packaging Cardboard box

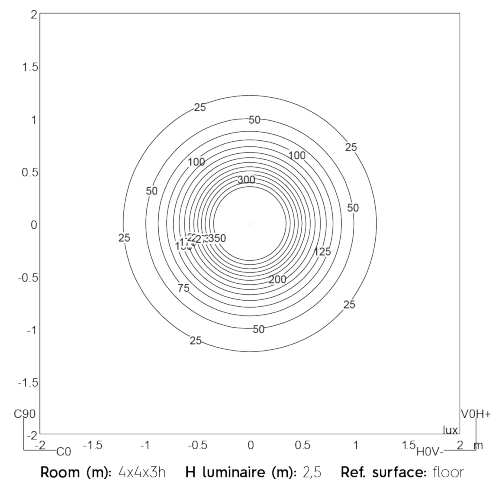
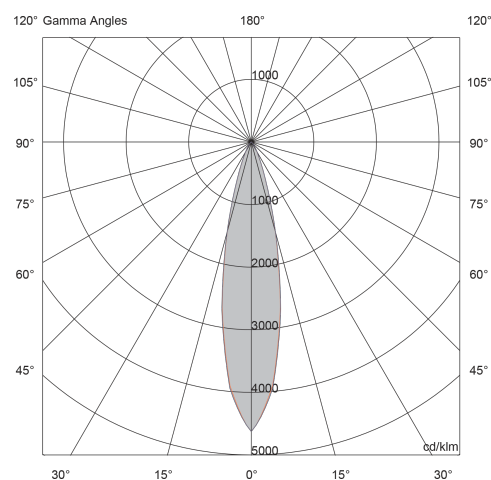

Certifications / Certificazioni



Technical info / Info tecniche



Other colour temperatures and CRI available upon request. All values marked with an (*) are rated values. Unless stated otherwise, the values apply to an ambient temperature of 25°C.

Luminous flux is subject to a normal technology drop over time. A.A.G. Stucchi reserves the right to make technical changes without prior notice. Real power: ±10% tolerance

Other colour temperatures and CRI available upon request. All values marked with an (*) are rated values. Unless stated otherwise, the values apply to an ambient temperature of 25°C.

Luminous flux is subject to a normal technology drop over time. A.A.G. Stucchi reserves the right to make technical changes without prior notice. Real power: ±10% tolerance



CLIC SPOT F41 CORE11 / CLIC SPOT F41 CORE11

PRODUCT CODE / CODICE PRODOTTO

F41/B5-B-5-C

DESCRIPTION / DESCRIZIONE

48V spot. For 9600C CORE11 tracks. Aluminum body. PMMA Lens 24°. Ø41x176mm.

48V spot. For 9600C CORE11 tracks. Aluminum body. PMMA Lens 24°. Ø41x176mm.

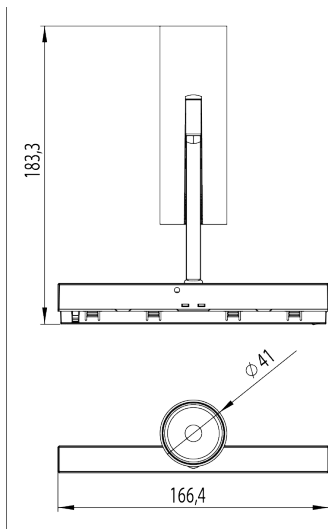

TECHNICAL DATA / DATI TECNICI

Application ON TRACK

Real Flux(lm) 733.14

Nominal Flux(lm) 950.6

Real Power(W) 9.1

Efficiency(lm / W) 80.6

LED source LED

Colour Temperature(K) 3000

CRI 90

MacAdam ≤ 3

Beam Angle 22,8°

UGR

≤ 16	X=4H Y=8H S=0.25H	
	Reflection factors:	70/50/20
	UGR transversal:	14.4
	UGR axial:	14.7

Lifetime(Khr) >60Khr L85B5

Driver CASAMBI

VF ~ 35

I LED(mA) 250

L(mm) 0

Weight(g) 215

Materials Aluminium body + PMMA lens + polycarbonate antiglare

Colour Nero

Mounting Mechanical

Packaging Cardboard box

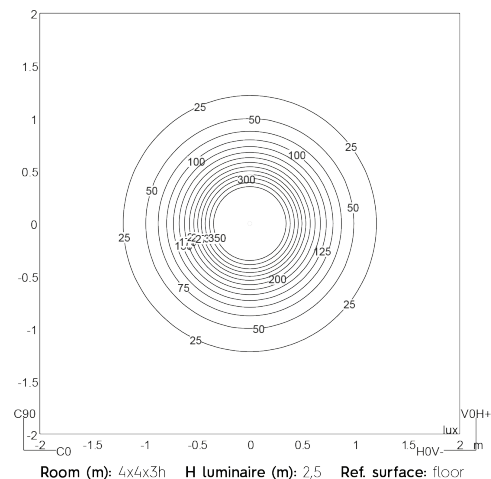
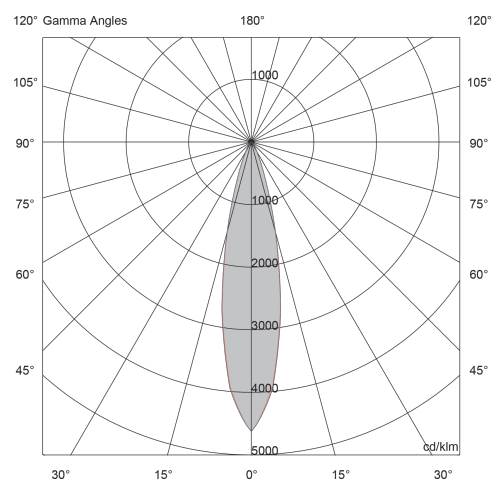

Certifications / Certificazioni



Technical info / Info tecniche



Other colour temperatures and CRI available upon request. All values marked with an (*) are rated values. Unless stated otherwise, the values apply to an ambient temperature of 25°C.

Luminous flux is subject to a normal technology drop over time. A.A.G. Stucchi reserves the right to make technical changes without prior notice. Real power: ±10% tolerance

Other colour temperatures and CRI available upon request. All values marked with an (*) are rated values. Unless stated otherwise, the values apply to an ambient temperature of 25°C.

Luminous flux is subject to a normal technology drop over time. A.A.G. Stucchi reserves the right to make technical changes without prior notice. Real power: ±10% tolerance



CLIC SPOT F41 CORE11 / CLIC SPOT F41 CORE11

PRODUCT CODE / CODICE PRODOTTO

F41/B5-B-9-C

DESCRIPTION / DESCRIZIONE

48V spot. For 9600C CORE11 tracks. Aluminum body. PMMA Lens 24°. Ø41x176mm.

48V spot. For 9600C CORE11 tracks. Aluminum body. PMMA Lens 24°. Ø41x176mm.

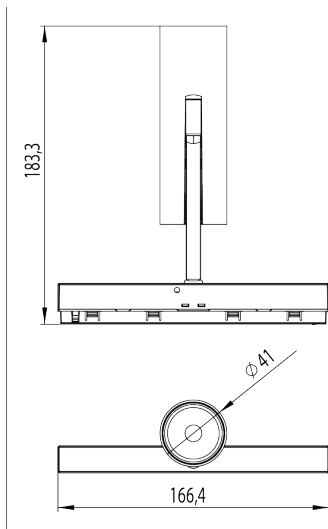

TECHNICAL DATA / DATI TECNICI

Application	ON TRACK						
LED source	LED						
Colour Temperature(K)	3000						
CRI	90						
MacAdam	≤ 3						
Beam Angle	22,8°						
UGR	<table border="1"> <tr> <td>≤ 16</td> <td>X=4H Y=8H</td> <td>S=0.25H</td> </tr> <tr> <td></td> <td colspan="2">Reflection factors: 70/50/20</td> </tr> </table>	≤ 16	X=4H Y=8H	S=0.25H		Reflection factors: 70/50/20	
≤ 16	X=4H Y=8H	S=0.25H					
	Reflection factors: 70/50/20						
Driver	NO DRIVER						
L(mm)	0						
Weight(g)	205						
Materials	Aluminium body + PMMA lens + polycarbonate antiglare						
Colour	Nero						
Mounting	Mechanical						
Packaging	Cardboard box						

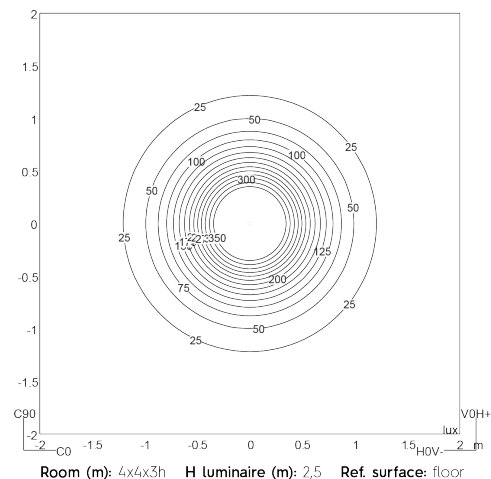
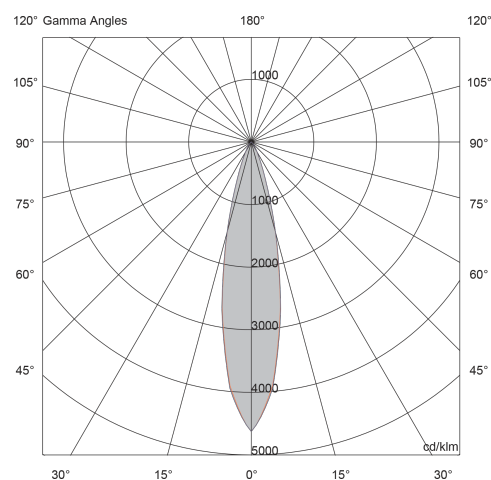

Technical info / Info tecniche



Other colour temperatures and CRI available upon request. All values marked with an (*) are rated values. Unless stated otherwise, the values apply to an ambient temperature of 25°C.

Luminous flux is subject to a normal technology drop over time. A.A.G. Stucchi reserves the right to make technical changes without prior notice. Real power: ±10% tolerance

Other colour temperatures and CRI available upon request. All values marked with an (*) are rated values. Unless stated otherwise, the values apply to an ambient temperature of 25°C.

Luminous flux is subject to a normal technology drop over time. A.A.G. Stucchi reserves the right to make technical changes without prior notice. Real power: ±10% tolerance



CLIC SPOT F41 CORE11 / CLIC SPOT F41 CORE11

PRODUCT CODE / CODICE PRODOTTO

F41/W25-B-0-C

DESCRIPTION / DESCRIZIONE

48V spot. For 9600C CORE11 tracks. Aluminum body. PMMA Lens 24°. Ø41x176mm.

48V spot. For 9600C CORE11 tracks. Aluminum body. PMMA Lens 24°. Ø41x176mm.

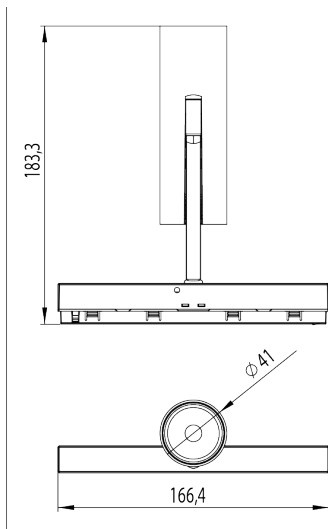

TECHNICAL DATA / DATI TECNICI

Application ON TRACK

Real Flux(lm) 733.14

Nominal Flux(lm) 950.6

Real Power(W) 9.1

Efficiency(lm / W) 80.6

LED source LED

Colour Temperature(K) 3000

CRI 90

MacAdam ≤ 3

Beam Angle 22,8°

UGR

≤ 16	X=4H Y=8H S=0.25H
	Reflection factors: 70/50/20
	UGR transversal: 14.4
	UGR axial: 14.7

Lifetime(Khr) >60Khr L85B5

Driver ON-OFF

VF ~ 35

I LED(mA) 250

L(mm) 0

Weight(g) 212

Materials Aluminium body + PMMA lens + polycarbonate antiglare

Colour Bianco

Mounting Mechanical

Packaging Cardboard box

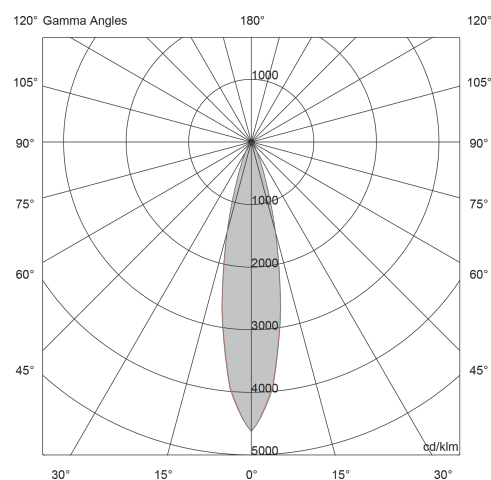

Certifications / Certificazioni



Technical info / Info tecniche



Other colour temperatures and CRI available upon request. All values marked with an (*) are rated values. Unless stated otherwise, the values apply to an ambient temperature of 25°C.

Luminous flux is subject to a normal technology drop over time. A.A.G. Stucchi reserves the right to make technical changes without prior notice. Real power: ±10% tolerance

Other colour temperatures and CRI available upon request. All values marked with an (*) are rated values. Unless stated otherwise, the values apply to an ambient temperature of 25°C.

Luminous flux is subject to a normal technology drop over time. A.A.G. Stucchi reserves the right to make technical changes without prior notice. Real power: ±10% tolerance



CLIC SPOT F41 CORE11 / CLIC SPOT F41 CORE11

PRODUCT CODE / CODICE PRODOTTO

F41/W25-B-2-C

DESCRIPTION / DESCRIZIONE

48V spot. For 9600C CORE11 tracks. Aluminum body. PMMA Lens 24°. Ø41x176mm.

48V spot. For 9600C CORE11 tracks. Aluminum body. PMMA Lens 24°. Ø41x176mm.

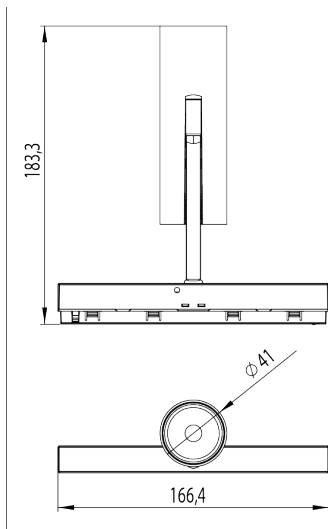

TECHNICAL DATA / DATI TECNICI

Application ON TRACK

Real Flux(lm) 733.14

Nominal Flux(lm) 950.6

Real Power(W) 9.1

Efficiency(lm / W) 80.6

LED source LED

Colour Temperature(K) 3000

CRI 90

MacAdam ≤ 3

Beam Angle 22,8°

UGR

≤ 16	X=4H Y=8H S=0.25H
	Reflection factors: 70/50/20
	UGR transversal: 14.4
	UGR axial: 14.7

Lifetime(Khr) >60Khr L85B5

Driver DALI 2

VF ~ 35

I LED(mA) 250

L(mm) 0

Weight(g) 218

Materials Aluminium body + PMMA lens + polycarbonate antiglare

Colour Bianco

Mounting Mechanical

Packaging Cardboard box

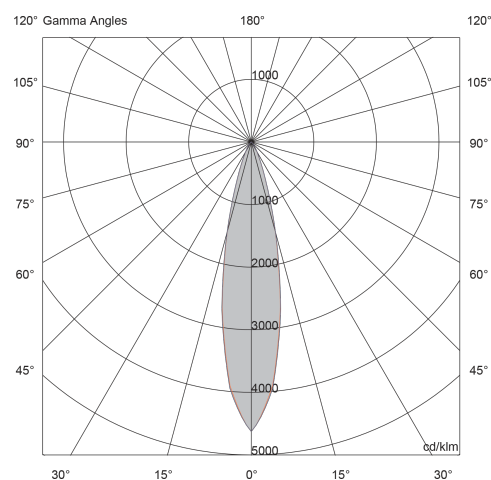

Certifications / Certificazioni



Technical info / Info tecniche



Other colour temperatures and CRI available upon request. All values marked with an (*) are rated values. Unless stated otherwise, the values apply to an ambient temperature of 25°C.

Luminous flux is subject to a normal technology drop over time. A.A.G. Stucchi reserves the right to make technical changes without prior notice. Real power: ±10% tolerance

Other colour temperatures and CRI available upon request. All values marked with an (*) are rated values. Unless stated otherwise, the values apply to an ambient temperature of 25°C.

Luminous flux is subject to a normal technology drop over time. A.A.G. Stucchi reserves the right to make technical changes without prior notice. Real power: ±10% tolerance



CLIC SPOT F41 CORE11 / CLIC SPOT F41 CORE11

PRODUCT CODE / CODICE PRODOTTO

F41/W25-B-5-C

DESCRIPTION / DESCRIZIONE

48V spot. For 9600C CORE11 tracks. Aluminum body. PMMA Lens 24°. Ø41x176mm.

48V spot. For 9600C CORE11 tracks. Aluminum body. PMMA Lens 24°. Ø41x176mm.

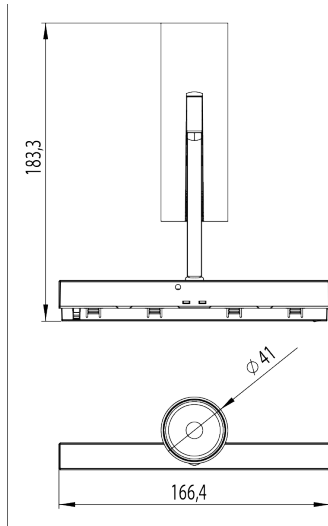

TECHNICAL DATA / DATI TECNICI

Application ON TRACK

Real Flux(lm) 733.14

Nominal Flux(lm) 950.6

Real Power(W) 9.1

Efficiency(lm / W) 80.6

LED source LED

Colour Temperature(K) 3000

CRI 90

MacAdam ≤ 3

Beam Angle 22,8°

UGR

≤ 16	X=4H Y=8H S=0.25H
	Reflection factors: 70/50/20
	UGR transversal: 14.4
	UGR axial: 14.7

Lifetime(Khr) >60Khr L85B5

Driver CASAMBI

VF ~ 35

I LED(mA) 250

L(mm) 0

Weight(g) 215

Materials Aluminium body + PMMA lens + polycarbonate antiglare

Colour Bianco

Mounting Mechanical

Packaging Cardboard box

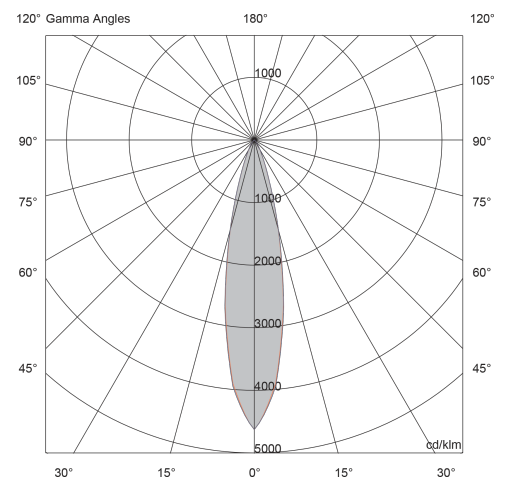

Certifications / Certificazioni

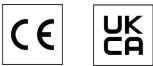

Technical info / Info tecniche



Other colour temperatures and CRI available upon request. All values marked with an (*) are rated values. Unless stated otherwise, the values apply to an ambient temperature of 25°C.

Luminous flux is subject to a normal technology drop over time. A.A.G. Stucchi reserves the right to make technical changes without prior notice. Real power: ±10% tolerance

Other colour temperatures and CRI available upon request. All values marked with an (*) are rated values. Unless stated otherwise, the values apply to an ambient temperature of 25°C.

Luminous flux is subject to a normal technology drop over time. A.A.G. Stucchi reserves the right to make technical changes without prior notice. Real power: ±10% tolerance



CLIC SPOT F41 CORE11 / CLIC SPOT F41 CORE11

PRODUCT CODE / CODICE PRODOTTO

F41/W25-B-9-C

DESCRIPTION / DESCRIZIONE

48V spot. For 9600C CORE11 tracks. Aluminum body. PMMA Lens 24°. Ø41x176mm.

48V spot. For 9600C CORE11 tracks. Aluminum body. PMMA Lens 24°. Ø41x176mm.

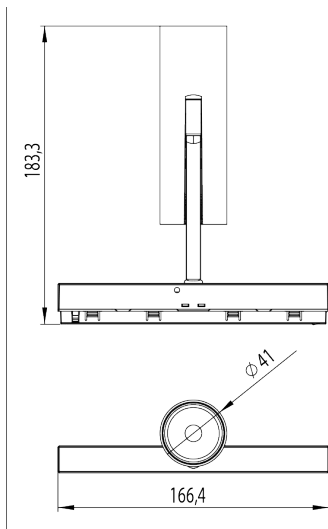

TECHNICAL DATA / DATI TECNICI

Application	ON TRACK						
LED source	LED						
Colour Temperature(K)	3000						
CRI	90						
MacAdam	≤ 3						
Beam Angle	22,8°						
UGR	<table border="1"> <tr> <td>≤ 16</td> <td>X=4H Y=8H</td> <td>S=0.25H</td> </tr> <tr> <td></td> <td colspan="2">Reflection factors: 70/50/20</td> </tr> </table>	≤ 16	X=4H Y=8H	S=0.25H		Reflection factors: 70/50/20	
≤ 16	X=4H Y=8H	S=0.25H					
	Reflection factors: 70/50/20						
Driver	NO DRIVER						
L(mm)	0						
Weight(g)	205						
Materials	Aluminium body + PMMA lens + polycarbonate antiglare						
Colour	Bianco						
Mounting	Mechanical						
Packaging	Cardboard box						

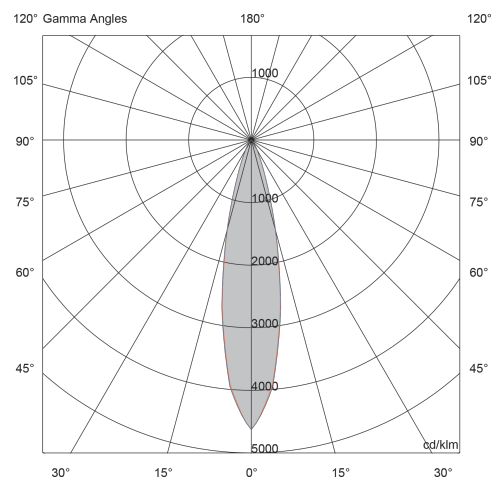

Technical info / Info tecniche



Other colour temperatures and CRI available upon request. All values marked with an (*) are rated values. Unless stated otherwise, the values apply to an ambient temperature of 25°C.

Luminous flux is subject to a normal technology drop over time. A.A.G. Stucchi reserves the right to make technical changes without prior notice. Real power: ±10% tolerance

Other colour temperatures and CRI available upon request. All values marked with an (*) are rated values. Unless stated otherwise, the values apply to an ambient temperature of 25°C.

Luminous flux is subject to a normal technology drop over time. A.A.G. Stucchi reserves the right to make technical changes without prior notice. Real power: ±10% tolerance