

Module LLE 24mm 1250lm CRI90 HV ADV6

Modules LLE advanced



LLE 24x70mm 325lm HV ADV6



LLE 24x140mm 650lm HV ADV6



LLE 24x280mm 1250lm HV ADV6

Product description

- _ Ideal for linear and panel lights
- _ 2 terminals for serial wiring
- _ 4,000 K module COI approved acc. to AS/NZS1680.2.5:1997
- _ Perfectly uniform light, even if several LED modules are used together in a line
- _ Push terminals for quick and simple wiring of LED module to LED module
- _ Broad portfolio from extruded lenses and covers available
- _ HE ... High Efficiency, NM ... Nominal Mode, HO ... High Output
- _ Min. order quantity LLE 24x70mm QTY4: 36 pcs. The LLE 24x70mm QTY4 module contains 4 single 24x70mm modules which have to be separated
- _ Long lifetime up to 72,000 hours
- _ 5 years guarantee (conditions at <https://www.tridonic.com/manufacturer-guarantee-conditions>)

Optical properties

- _ Colour temperatures 2,700, 3,000, 3,500 and 4,000 K
- _ Useful luminous flux 2,082 lm at Irated and tp = 25 °C
- _ Efficacy of the LED module 172 lm/W at Irated and tp = 25 °C
- _ High colour rendering index CRI > 90
- _ High colour consistency (MacAdam 3) ^①
- _ Small luminous flux tolerances

Mechanical properties

- _ Module dimension 24 x 70 mm, 24 x 140 mm, 24 x 280 mm and 24 x 560 mm (ZHAGA compliant)
- _ Simple installation via clips or screws

System solution

- _ Combine Tridonic's LED modules and dimmable drivers to achieve an outstanding system efficacy (configuration possible via <https://setbuilder.tridonic.com/>)

^① Integral measurement over the complete module.

Website

<http://www.tridonic.com/28004731>

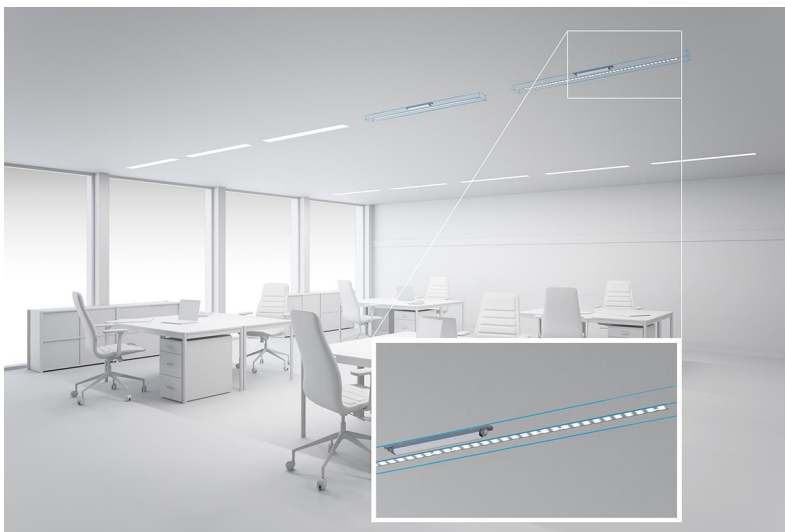

Spotlights



Downlights



Linear



Area



Floor | Wall



Free-standing



Street



Decorative



High bay

Module LLE 24mm 1250lm CRI90 HV ADV6

Modules LLE advanced

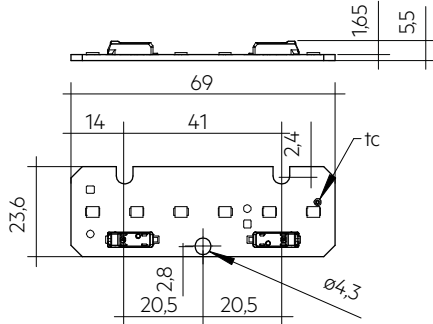

LLE 24x70mm 325lm HV ADV6

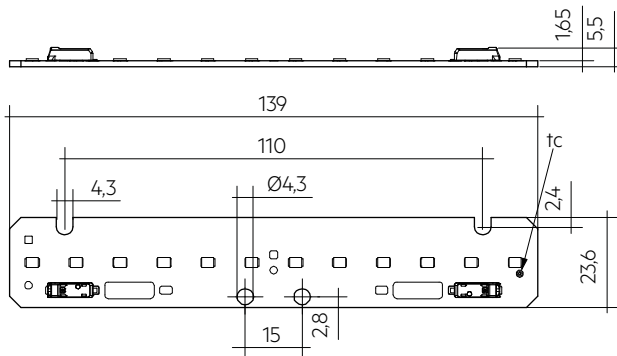

LLE 24x140mm 650lm HV ADV6

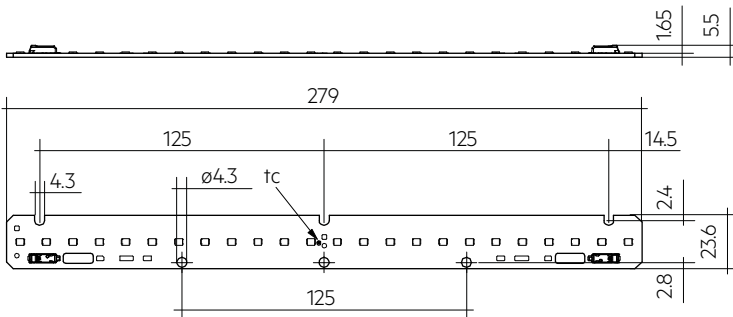

LLE 24x280mm 1250lm HV ADV6

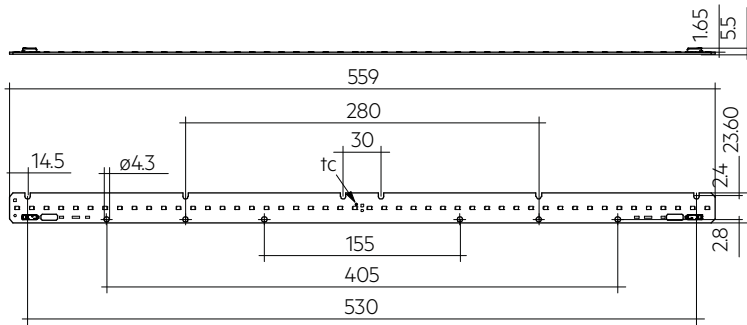

LLE 24x560mm 2400lm HV ADV6

Ordering data

Type	Article number	Colour temperature	Packaging, carton	Weight per pc.
LLE 24x70mm 325lm 927 HV ADV6 QTY4	28004731	2,700 K	108 pc(s).	0.022 kg
LLE 24x70mm 325lm 930 HV ADV6 QTY4	28004733	3,000 K	108 pc(s).	0.022 kg
LLE 24x70mm 325lm 935 HV ADV6 QTY4	28004736	3,500 K	108 pc(s).	0.022 kg
LLE 24x70mm 325lm 940 HV ADV6 QTY4	28004737	4,000 K	108 pc(s).	0.022 kg
LLE 24x140mm 650lm 927 HV ADV6	28004756	2,700 K	108 pc(s).	0.011 kg
LLE 24x140mm 650lm 930 HV ADV6	28004757	3,000 K	108 pc(s).	0.011 kg
LLE 24x140mm 650lm 935 HV ADV6	28004758	3,500 K	108 pc(s).	0.011 kg
LLE 24x140mm 650lm 940 HV ADV6	28004759	4,000 K	108 pc(s).	0.011 kg
LLE 24x280mm 1250lm 927 HV ADV6	28004767	2,700 K	108 pc(s).	0.023 kg
LLE 24x280mm 1250lm 930 HV ADV6	28004768	3,000 K	108 pc(s).	0.023 kg
LLE 24x280mm 1250lm 935 HV ADV6	28004769	3,500 K	108 pc(s).	0.023 kg
LLE 24x280mm 1250lm 940 HV ADV6	28004770	4,000 K	108 pc(s).	0.023 kg
LLE 24x560mm 2400lm 927 HV ADV6	28004778	2,700 K	108 pc(s).	0.041 kg
LLE 24x560mm 2400lm 930 HV ADV6	28004779	3,000 K	108 pc(s).	0.041 kg
LLE 24x560mm 2400lm 935 HV ADV6	28004780	3,500 K	108 pc(s).	0.041 kg
LLE 24x560mm 2400lm 940 HV ADV6	28004781	4,000 K	108 pc(s).	0.041 kg

Technical data

Beam characteristic	120°
Ambient temperature t_a	-40 ... +65 °C
t_p rated	50 °C
t_c	85 °C
I_{rated}	275 mA
I_{max}	800 mA
Max. permissible LF current ripple	900 mA
Max. permissible peak current	1,350 mA / max. 10 ms
Max. working voltage for insulation [®]	440 V
Insulation test voltage	1.88 kV
Colour tolerance	3 SDCM
ESD classification	Severity level 2
Risk group (IEC 62471)	RG1 (> 280 – 800 mA (I_{max})), RGO (\leq 280 mA)
Classification acc. to IEC 62031	Built-in
Type of protection	IP00
Lumen maintenance L70B50	72,000 h
Guarantee (conditions at www.tridonic.com)	5 Year(s)

Approval marks**Standards**

IEC 62031, IEC 62471, IEC 61000-4-2, IEC 62778, IEC 61547

Specific technical data

Type	Article number	Photometric code ^②	Useful luminous flux at tp = 25 °C ^③	Expected luminous flux at tp rated ^④	Typ. forward current	Min. forward voltage at tp rated ^⑤	Max. forward voltage at tp = 25 °C ^⑥	Power consumption Pon at tp = 25 °C ^⑦	Efficacy of the module at tp = 25 °C	Expected efficacy of the module at tp rated	Colour rendering index CRI
Operating mode HE											
LLE 24x70mm 325lm 927 HV ADV6 QTY4	28004731	927/359	-	86 lm	100 mA	5.0 V	5.5 V	-	-	164 lm/W	>90
LLE 24x70mm 325lm 930 HV ADV6 QTY4	28004733	930/359	-	89 lm	100 mA	5.0 V	5.5 V	-	-	169 lm/W	>90
LLE 24x70mm 325lm 935 HV ADV6 QTY4	28004736	935/359	-	91 lm	100 mA	5.0 V	5.5 V	-	-	173 lm/W	>90
LLE 24x70mm 325lm 940 HV ADV6 QTY4	28004737	940/359	-	93 lm	100 mA	5.0 V	5.5 V	-	-	175 lm/W	>90
LLE 24x140mm 650lm 927 HV ADV6	28004756	927/359	-	173 lm	100 mA	10.1 V	11.0 V	-	-	164 lm/W	>90
LLE 24x140mm 650lm 930 HV ADV6	28004757	930/359	-	178 lm	100 mA	10.1 V	11.0 V	-	-	169 lm/W	>90
LLE 24x140mm 650lm 935 HV ADV6	28004758	935/359	-	183 lm	100 mA	10.1 V	11.0 V	-	-	173 lm/W	>90
LLE 24x140mm 650lm 940 HV ADV6	28004759	940/359	-	185 lm	100 mA	10.1 V	11.0 V	-	-	175 lm/W	>90
LLE 24x280mm 1250lm 927 HV ADV6	28004767	927/359	-	346 lm	100 mA	20.2 V	22.0 V	-	-	164 lm/W	>90
LLE 24x280mm 1250lm 930 HV ADV6	28004768	930/359	-	356 lm	100 mA	20.2 V	22.0 V	-	-	169 lm/W	>90
LLE 24x280mm 1250lm 935 HV ADV6	28004769	935/359	-	366 lm	100 mA	20.2 V	22.0 V	-	-	173 lm/W	>90
LLE 24x280mm 1250lm 940 HV ADV6	28004770	940/359	-	370 lm	100 mA	20.2 V	22.0 V	-	-	175 lm/W	>90
LLE 24x560mm 2400lm 927 HV ADV6	28004778	927/359	-	691 lm	100 mA	40.3 V	43.9 V	-	-	164 lm/W	>90
LLE 24x560mm 2400lm 930 HV ADV6	28004779	930/359	-	712 lm	100 mA	40.3 V	43.9 V	-	-	169 lm/W	>90
LLE 24x560mm 2400lm 935 HV ADV6	28004780	935/359	-	731 lm	100 mA	40.3 V	43.9 V	-	-	173 lm/W	>90
LLE 24x560mm 2400lm 940 HV ADV6	28004781	940/359	-	741 lm	100 mA	40.3 V	43.9 V	-	-	175 lm/W	>90
Operating mode NM											
LLE 24x70mm 325lm 927 HV ADV6 QTY4	28004731	927/359	243 lm	233 lm	275 mA	5.2 V	5.7 V	1.5 W	160 lm/W	155 lm/W	>90
LLE 24x70mm 325lm 930 HV ADV6 QTY4	28004733	930/359	250 lm	240 lm	275 mA	5.2 V	5.7 V	1.5 W	165 lm/W	160 lm/W	>90
LLE 24x70mm 325lm 935 HV ADV6 QTY4	28004736	935/359	257 lm	247 lm	275 mA	5.2 V	5.7 V	1.5 W	170 lm/W	164 lm/W	>90
LLE 24x70mm 325lm 940 HV ADV6 QTY4	28004737	940/359	260 lm	250 lm	275 mA	5.2 V	5.7 V	1.5 W	172 lm/W	166 lm/W	>90
LLE 24x140mm 650lm 927 HV ADV6	28004756	927/359	486 lm	466 lm	275 mA	10.4 V	11.4 V	3.0 W	160 lm/W	155 lm/W	>90
LLE 24x140mm 650lm 930 HV ADV6	28004757	930/359	501 lm	480 lm	275 mA	10.4 V	11.4 V	3.0 W	165 lm/W	160 lm/W	>90
LLE 24x140mm 650lm 935 HV ADV6	28004758	935/359	514 lm	493 lm	275 mA	10.4 V	11.4 V	3.0 W	169 lm/W	164 lm/W	>90
LLE 24x140mm 650lm 940 HV ADV6	28004759	940/359	520 lm	499 lm	275 mA	10.4 V	11.4 V	3.0 W	172 lm/W	166 lm/W	>90
LLE 24x280mm 1250lm 927 HV ADV6	28004767	927/359	971 lm	932 lm	275 mA	20.9 V	22.7 V	6.1 W	160 lm/W	155 lm/W	>90
LLE 24x280mm 1250lm 930 HV ADV6	28004768	930/359	1,001 lm	961 lm	275 mA	20.9 V	22.7 V	6.1 W	165 lm/W	160 lm/W	>90
LLE 24x280mm 1250lm 935 HV ADV6	28004769	935/359	1,028 lm	986 lm	275 mA	20.9 V	22.7 V	6.1 W	169 lm/W	164 lm/W	>90
LLE 24x280mm 1250lm 940 HV ADV6	28004770	940/359	1,041 lm	999 lm	275 mA	20.9 V	22.7 V	6.1 W	172 lm/W	166 lm/W	>90
LLE 24x560mm 2400lm 927 HV ADV6	28004778	927/359	1,942 lm	1,864 lm	275 mA	41.8 V	45.4 V	12.1 W	160 lm/W	155 lm/W	>90
LLE 24x560mm 2400lm 930 HV ADV6	28004779	930/359	2,002 lm	1,921 lm	275 mA	41.8 V	45.4 V	12.1 W	165 lm/W	160 lm/W	>90
LLE 24x560mm 2400lm 935 HV ADV6	28004780	935/359	2,055 lm	1,972 lm	275 mA	41.8 V	45.4 V	12.1 W	169 lm/W	164 lm/W	>90
LLE 24x560mm 2400lm 940 HV ADV6	28004781	940/359	2,082 lm	1,998 lm	275 mA	41.8 V	45.4 V	12.1 W	172 lm/W	166 lm/W	>90
Operating mode HO											
LLE 24x70mm 325lm 927 HV ADV6 QTY4	28004731	927/359	-	553 lm	700 mA	5.5 V	6.0 V	-	-	136 lm/W	>90
LLE 24x70mm 325lm 930 HV ADV6 QTY4	28004733	930/359	-	570 lm	700 mA	5.5 V	6.0 V	-	-	140 lm/W	>90
LLE 24x70mm 325lm 935 HV ADV6 QTY4	28004736	935/359	-	585 lm	700 mA	5.5 V	6.0 V	-	-	144 lm/W	>90
LLE 24x70mm 325lm 940 HV ADV6 QTY4	28004737	940/359	-	593 lm	700 mA	5.5 V	6.0 V	-	-	146 lm/W	>90
LLE 24x140mm 650lm 927 HV ADV6	28004756	927/359	-	1,106 lm	700 mA	11.1 V	12.0 V	-	-	136 lm/W	>90
LLE 24x140mm 650lm 930 HV ADV6	28004757	930/359	-	1,140 lm	700 mA	11.1 V	12.0 V	-	-	141 lm/W	>90
LLE 24x140mm 650lm 935 HV ADV6	28004758	935/359	-	1,171 lm	700 mA	11.1 V	12.0 V	-	-	144 lm/W	>90
LLE 24x140mm 650lm 940 HV ADV6	28004759	940/359	-	1,186 lm	700 mA	11.1 V	12.0 V	-	-	146 lm/W	>90
LLE 24x280mm 1250lm 927 HV ADV6	28004767	927/359	-	2,213 lm	700 mA	22.2 V	24.0 V	-	-	136 lm/W	>90
LLE 24x280mm 1250lm 930 HV ADV6	28004768	930/359	-	2,281 lm	700 mA	22.2 V	24.0 V	-	-	141 lm/W	>90
LLE 24x280mm 1250lm 935 HV ADV6	28004769	935/359	-	2,341 lm	700 mA	22.2 V	24.0 V	-	-	144 lm/W	>90
LLE 24x280mm 1250lm 940 HV ADV6	28004770	940/359	-	2,371 lm	700 mA	22.2 V	24.0 V	-	-	146 lm/W	>90
LLE 24x560mm 2400lm 927 HV ADV6	28004778	927/359	-	4,426 lm	700 mA	44.4 V	48.1 V	-	-	136 lm/W	>90
LLE 24x560mm 2400lm 930 HV ADV6	28004779	930/359	-	4,562 lm	700 mA	44.4 V	48.1 V	-	-	141 lm/W	>90
LLE 24x560mm 2400lm 935 HV ADV6	28004780	935/359	-	4,682 lm	700 mA	44.4 V	48.1 V	-	-	144 lm/W	>90
LLE 24x560mm 2400lm 940 HV ADV6	28004781	940/359	-	4,743 lm	700 mA	44.4 V	48.1 V	-	-	146 lm/W	>90

② If mounted with M4 screws with 7 mm head diameter.

③ The detailed explanation, see data sheet section 1.1.

④ Tolerance of useful light flux - 0 % / + 15 %. Measurement uncertainty ± 10 %.

⑤ Tolerance of expected light flux - 0 % / + 15 %. Measurement uncertainty ± 10 %. Based on calculation.

⑥ Measurement tolerance forward voltage: ±0.1 V.

⑦ Tolerance of power consumption Pon ± 10 %. Measurement uncertainty ± 5 %.

LINEAR COVER LLE

Accessory

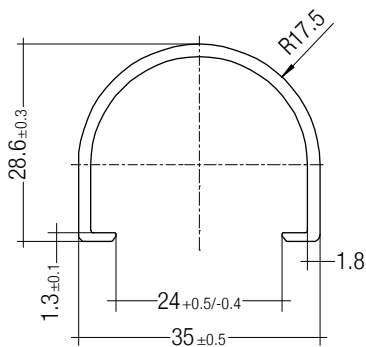

Product description

- _ LINEAR COVER for LLE
- _ Protection against direct touch for non-SELV applications (recommendation LLE 20: use all fixing points and screwed Endcap, recommendation LLE 24: use all fixing points)
- _ Fast snap on mounting on to LLE 20: with M4 screws and plastic washers, to LLE 24: with clips or plastic washers
- _ High transmission: transparent, semi-transparent and diffuse
- _ Material: PMMA
- _ Tolerances: ± 1 mm for 597 mm length (ends finished), + 10 mm from length 1,150 mm (ends raw)

Website

<http://www.tridonic.com/28000338>



Ordering data

Type	Article number	Colour	Length L	Efficiency	Packaging, carton	Weight per pc.
LINEAR COVER SY Transparent 1600mm	28000338	Transparent	1,600 mm	94 %	12 pc(s).	0.272 kg
LINEAR COVER SY Frosted 1800mm	28000437	Semi-transparent	1,800 mm	87 %	12 pc(s).	0.308 kg
LINEAR COVER SY Frosted 1600mm	28000339	Semi-transparent	1,600 mm	87 %	12 pc(s).	0.272 kg
LINEAR COVER SY Frosted 1500mm	28000435	Semi-transparent	1,500 mm	87 %	12 pc(s).	0.244 kg
LINEAR COVER SY Frosted 1200mm	28000422	Semi-transparent	1,200 mm	87 %	12 pc(s).	0.205 kg
LINEAR COVER SY Frosted 597mm	28000340	Semi-transparent	597 mm	87 %	12 pc(s).	0.102 kg
LINEAR COVER SY Diffuse 1800mm	28000438	Diffuse	1,800 mm	76 %	12 pc(s).	0.308 kg
LINEAR COVER SY Diffuse 1600mm	28000341	Diffuse	1,600 mm	76 %	12 pc(s).	0.272 kg
LINEAR COVER SY Diffuse 1500mm	28000436	Diffuse	1,500 mm	76 %	12 pc(s).	0.257 kg
LINEAR COVER SY Diffuse 1200mm	28000434	Diffuse	1,200 mm	76 %	12 pc(s).	0.205 kg
LINEAR COVER SY Diffuse 597mm	28000342	Diffuse	597 mm	76 %	12 pc(s).	0.102 kg

ACL ENDCAP LLE

Accessory

**Product description**

- _ ENDCAP for LLE
- _ PUSH-FIX: Fast snap on mounting (sheet thickness 0.5 – 1.0 mm), for drilling hole 4 mm
- _ SCREW-FIX: Screw mounting with EJOT Delta PT WN 5451 30x8 (not included), tightening torque 0.7 Nm
- _ Clip made of polycarbonate

Website

<http://www.tridonic.com/28001037>

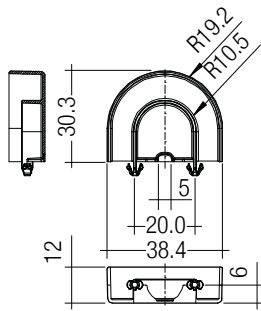
**Ordering data**

Type	Article number	Colour	Packaging, carton	Weight per pc.
ACL ENDCAP LLE24 PUSH-FIX	28001037	White	480 pc(s).	0.003 kg
ACL ENDCAP LLE24 SCREW-FIX	28002315	White	480 pc(s).	0.003 kg

ACL LINEAR LENS 24mm

Accessory

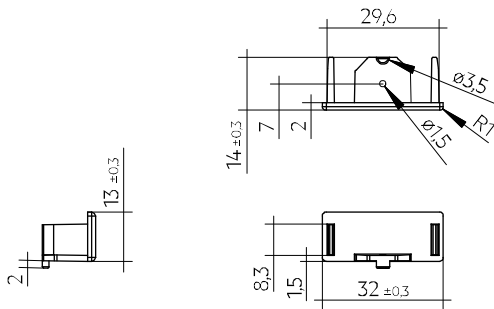
**Product description LINEAR LENS**

- _ Linear lens for LLE 20 / 24
- _ Available with different beam characteristics
- _ Protection against direct touch for non-SELV applications (recommendation: use all fixing points)
- _ Fast snap on mounting on to LLE 20: with M4 screws and plastic washers, to LLE 24: with clips or plastic washers
- _ Recommendation: Fastening with screws and plastic washers, see 2.3 Heat sink specifications in data sheet
- _ Material: PMMA
- _ Available lengths: 1,200, 1,500 and 1,800 mm, Tolerance: + 10 mm (ends raw)
- _ Max. permissible temperature 80 °C
- _ Photometric data available on website

Product description Endcap

- _ ENDCAP for LINEAR LENS 24mm INTENSE, ASY and DASY
- _ Mounting by clipping in and screwing from below using screw EJOT Delta PT WN 5451 20x4, tightening torque 0.7 Nm
- _ Made of Polyamide UL94 V0

Website

<http://www.tridonic.com/28001428>

**Ordering data**

Type	Article number	Length L	Beam characteristic	Efficiency	Packaging, carton	Weight per pc.
ACL LINEAR LENS 24x1200mm 60°	28001428	1,200 mm	60°	97 %	21 pc(s).	0.196 kg
ACL LINEAR LENS 24x1200mm 90°	28001429	1,200 mm	90°	97 %	21 pc(s).	0.165 kg
ACL LINEAR LENS 24x1500mm 60°	28000953	1,500 mm	60°	97 %	21 pc(s).	0.261 kg
ACL LINEAR LENS 24x1500mm 90°	28000955	1,500 mm	90°	97 %	21 pc(s).	0.221 kg
ACL LINEAR LENS 24x1200mm INTENSE	28002024	1,200 mm	40°	95 %	18 pc(s).	0.261 kg
ACL LINEAR LENS 24x1500mm INTENSE	28002025	1,500 mm	40°	95 %	18 pc(s).	0.326 kg
ACL LINEAR LENS 24x1800mm INTENSE	28002026	1,800 mm	40°	95 %	18 pc(s).	0.392 kg
ACL LINEAR LENS 24x1200mm BATWING	28002027	1,200 mm	batwing	95 %	18 pc(s).	0.275 kg
ACL LINEAR LENS 24x1500mm BATWING	28002028	1,500 mm	batwing	95 %	18 pc(s).	0.344 kg
ACL LINEAR LENS 24x1800mm BATWING	28002029	1,800 mm	batwing	95 %	18 pc(s).	0.412 kg
ACL LINEAR LENS 24x1200mm ASY	28002030	1,200 mm	asymmetric	95 %	18 pc(s).	0.250 kg
ACL LINEAR LENS 24x1500mm ASY	28002031	1,500 mm	asymmetric	95 %	18 pc(s).	0.312 kg
ACL LINEAR LENS 24x1800mm ASY	28002032	1,800 mm	asymmetric	95 %	18 pc(s).	0.375 kg
ACL LINEAR LENS 24x1200mm DASY	28002033	1,200 mm	double asymmetric	92 %	18 pc(s).	0.249 kg
ACL LINEAR LENS 24x1500mm DASY	28002034	1,500 mm	double asymmetric	92 %	18 pc(s).	0.311 kg
ACL LINEAR LENS 24x1800mm DASY	28002035	1,800 mm	double asymmetric	92 %	18 pc(s).	0.373 kg
ACL Endcap LENS 24mm PSF	28002669	-	-	-	3,600 pc(s).	0.003 kg

ACL CLIP 4.3mm

Accessory

**Product description**

- _ Clip for fixation of LED modules with 4.3 mm holes
- _ Fast snap on mounting (sheet thickness 0.5 – 1.0 mm for PUSH-FIX and 1 – 2 mm for PUSH-FIX Long)
- _ For drilling hole 4 mm
- _ Clip made of polycarbonate
- _ Minimum sales quantity 500 pcs.

Website

<http://www.tridonic.com/28001036>

**Ordering data**

Type	Article number	Colour	Packaging, bag ^①	Weight per pc.
ACL CLIP 4.3mm PUSH-FIX	28001036	White	500 pc(s).	0.001 kg
ACL CLIP 4,3mm PUSH-FIX Long	28002314	Transparent	500 pc(s).	0.001 kg

① Minimum sales quantity 500 pcs.

ACL BRIDGE LLE24/40

Accessory

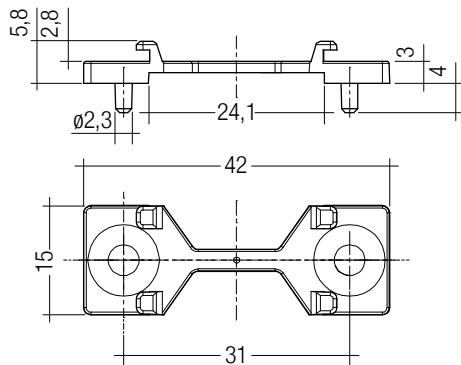
**Product description**

- _ Enables the fixation of 24 mm wide Tridonic LED modules to fixtures made for 40 mm wide modules
- _ Ideal for extruded aluminium gear trays made for 40 mm modules with pre-alignment knobs
- _ Clip-on for LINEAR COVER and LINEAR LENS ^①
- _ For LLE 24 with 280 mm module minimum 2 bridges required
- _ For LLE 24 with 560 mm module minimum 3 bridges required
- _ Fixation via M3 or M4 countersunk screw, max. tightening torque 0.5 Nm
- _ BRIDGE made of white polycarbonate
- _ Minimum sales quantity 600 pcs.

^① Beam characteristics will change due to the elevated fixation (see photometric files for details).

Website

<http://www.tridonic.com/28001205>

**Ordering data**

Type	Article number	Colour	Packaging, carton	Weight per pc.
ACL BRIDGE LLE24/40 SCREW-FIX	28001205	White	600 pc(s).	0.001 kg

1. Standards

IEC 62031
IEC 62471
IEC 61000-4-2
IEC 62778
IEC 61547

1.1 Photometric code

Key for photometric code, e. g. 830 / 349

1 st digit	2 nd + 3 rd digit	4 th digit	5 th digit	6 th digit
Code CRI	Colour temperature in Kelvin x 100	MacAdam initial	MacAdam after 25% of the lifetime (max.6000h)	Luminous flux after 25% of the lifetime (max.6000h)
				Code Luminous flux
				7 ≥ 70 %
8 80 – 89				8 ≥ 80 %
9 ≥90				9 ≥ 90 %

1.2 Risk group

Forward current	Risk group (IEC 62471)
≤ 280 mA	RG0
> 280 – 800 mA (Imax)	RG1

1.3 Energy classification

Type	Colour temperature	Forward current	Energy classification	Energy consumption
LLE 24x70mm 325lm 927 HV ADV6 QTY4	2,700 K	275 mA	D	2 kWh / 1,000 h
LLE 24x70mm 325lm 930 HV ADV6 QTY4	3,000 K	275 mA	D	2 kWh / 1,000 h
LLE 24x70mm 325lm 935 HV ADV6 QTY4	3,500 K	275 mA	D	2 kWh / 1,000 h
LLE 24x70mm 325lm 940 HV ADV6 QTY4	4,000 K	275 mA	C	2 kWh / 1,000 h
LLE 24x140mm 650lm 927 HV ADV6	2,700 K	275 mA	D	4 kWh / 1,000 h
LLE 24x140mm 650lm 930 HV ADV6	3,000 K	275 mA	D	4 kWh / 1,000 h
LLE 24x140mm 650lm 935 HV ADV6	3,500 K	275 mA	D	4 kWh / 1,000 h
LLE 24x140mm 650lm 940 HV ADV6	4,000 K	275 mA	C	4 kWh / 1,000 h
LLE 24x280mm 1250lm 927 HV ADV6	2,700 K	275 mA	D	7 kWh / 1,000 h
LLE 24x280mm 1250lm 930 HV ADV6	3,000 K	275 mA	D	7 kWh / 1,000 h
LLE 24x280mm 1250lm 935 HV ADV6	3,500 K	275 mA	D	7 kWh / 1,000 h
LLE 24x280mm 1250lm 940 HV ADV6	4,000 K	275 mA	D	7 kWh / 1,000 h
LLE 24x560mm 2400lm 927 HV ADV6	2,700 K	275 mA	D	13 kWh / 1,000 h
LLE 24x560mm 2400lm 930 HV ADV6	3,000 K	275 mA	D	13 kWh / 1,000 h
LLE 24x560mm 2400lm 935 HV ADV6	3,500 K	275 mA	D	13 kWh / 1,000 h
LLE 24x560mm 2400lm 940 HV ADV6	4,000 K	275 mA	D	13 kWh / 1,000 h

Energy label and further information at www.tridonic.com in the certificates tab of the corresponding product page and at the EPREL data base <https://eprel.ec.europa.eu/>

2. Thermal details

2.1 tc point, ambient temperature and lifetime

The temperature at tp reference point is crucial for the light output and lifetime of a LED product.

For LLE a tp temperature of 50 °C has to be complied in order to achieve an optimum between heat sink requirements, light output and lifetime.

Compliance with the maximum permissible reference temperature at the tc point must be checked under operating conditions in a thermally stable state. The maximum value must be determined under worst-case conditions for the relevant application.

The tc and tp temperature of LED modules from Tridonic are measured at the same reference point.

2.2 Storage and humidity

Storage temperature	-40 ... +80 °C
---------------------	----------------

Operation only in non condensing environment.

Humidity during processing of the module should be between 30 to 70 %.

2.3 Heat sink values

LLE 24x70mm 325lm ADV6

ta	tp	Forward current	R _{th, hs-a}	Cooling area
25 °C	50 °C	275 mA	3397 K/W	20 cm ²
25 °C	50 °C	700 mA	8.46 K/W	79 cm ²
35 °C	50 °C	275 mA	19.24 K/W	35 cm ²
35 °C	50 °C	700 mA	3.93 K/W	169 cm ²
40 °C	50 °C	275 mA	11.87 K/W	56 cm ²
40 °C	50 °C	700 mA	1.67 K/W	399 cm ²
45 °C	50 °C	275 mA	4.51 K/W	148 cm ²
45 °C	50 °C	700 mA	–	–

LLE 24x140mm 650lm ADV6

ta	tp	Forward current	R _{th, hs-a}	Cooling area
25 °C	50 °C	275 mA	16.98 K/W	39 cm ²
25 °C	50 °C	700 mA	4.23 K/W	158 cm ²
35 °C	50 °C	275 mA	9.62 K/W	69 cm ²
35 °C	50 °C	700 mA	1.97 K/W	339 cm ²
40 °C	50 °C	275 mA	5.94 K/W	112 cm ²
40 °C	50 °C	700 mA	0.84 K/W	798 cm ²
45 °C	50 °C	275 mA	2.25 K/W	296 cm ²
45 °C	50 °C	700 mA	–	–

LLE 24x280mm 1250lm ADV6

ta	tp	Forward current	R _{th, hs-a}	Cooling area
25 °C	50 °C	275 mA	8.49 K/W	79 cm ²
25 °C	50 °C	700 mA	2.12 K/W	315 cm ²
35 °C	50 °C	275 mA	4.81 K/W	139 cm ²
35 °C	50 °C	700 mA	0.98 K/W	678 cm ²
40 °C	50 °C	275 mA	2.97 K/W	225 cm ²
40 °C	50 °C	700 mA	0.42 K/W	1,596 cm ²
45 °C	50 °C	275 mA	1.13 K/W	592 cm ²
45 °C	50 °C	700 mA	–	–

LLE 24x560mm 2400lm ADV6

ta	tp	Forward current	R _{th, hs-a}	Cooling area
25 °C	50 °C	275 mA	4.25 K/W	157 cm ²
25 °C	50 °C	700 mA	1.06 K/W	630 cm ²
35 °C	50 °C	275 mA	2.40 K/W	277 cm ²
35 °C	50 °C	700 mA	0.49 K/W	1,356 cm ²
40 °C	50 °C	275 mA	1.48 K/W	449 cm ²
40 °C	50 °C	700 mA	0.21 K/W	3,192 cm ²
45 °C	50 °C	275 mA	0.56 K/W	1,183 cm ²
45 °C	50 °C	700 mA	–	–

Notes

The actual cooling surface can differ because of the material, the structural shape, outside influences and the installation situation. Depending on the heat sink a heat conducting paste or heat conducting film might be necessary to keep the specified tp temperature.

For applications with a small distance between LED module and lens, screw mounting is recommended to ensure a reliable thermal connection between LED module and cooling surface.

3. Installation / wiring

3.1 Electrical supply/choice of LED driver

LLE modules from Tridonic are not protected against overvoltages, overcurrents, overloads or short-circuit currents. Safe and reliable operation can only be guaranteed in conjunction with a LED driver which complies with the relevant standards. The use of LED driver from Tridonic in combination with LLE modules guarantees the necessary protection for safe and reliable operation.

If a LED driver other than Tridonic is used, it must provide the following protection:

- Short-circuit protection
- Overload protection
- Overtemperature protection



LLE modules must be supplied by a constant current LED driver. Operation with a constant voltage LED driver will lead to an irreversible damage of the module.

Wrong polarity can damage the LLE.

The LLE module is designed for serial wiring.

With parallel wiring tolerance-related differences in output are possible (thermal stress of the module) and can cause differences in brightness.

If a wire breaks or a complete module fails then the current passing through the other module increases. This may reduce its life considerably.

Max. 8 pieces 280 mm modules or 4 pieces 560 mm modules may be connected in parallel.

The max. permissible output current of the LED driver for parallel wiring is 1.8 A. For applications with a small distance between LED module and lens, an output current of 1.35 A must not be exceeded.

LLE can be operated either from SELV LED drivers or from LED drivers with LV output voltage.



LLE are basic insulated up to 440 V (if mounted with M4 screws with head diameter 7 mm) against ground and can be mounted directly on earthed metal parts of the luminaire. If the max. output voltage of the LED driver (also against earth) is above 440 V, an additional insulation between LED module and heat sink is required (for example by insulated thermal pads) or by a suitable luminaire construction.

At voltages > 60 V an additional protection against direct touch (test finger) to the light emitting side of the module has to be guaranteed. This is typically achieved by means of a non removable light distributor over the module.

3.2 Wiring

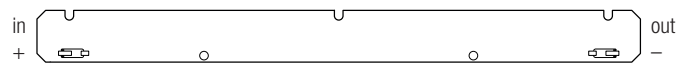

Wiring examples for serial wiring

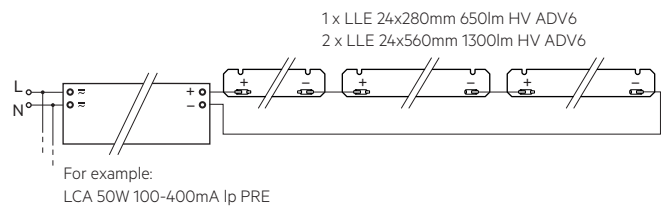
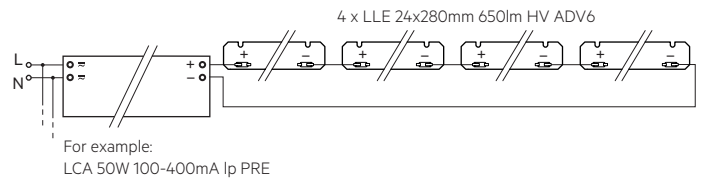

Wiring examples for parallel wiring

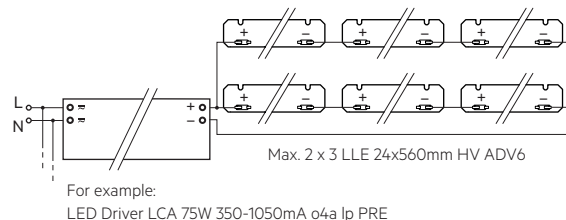
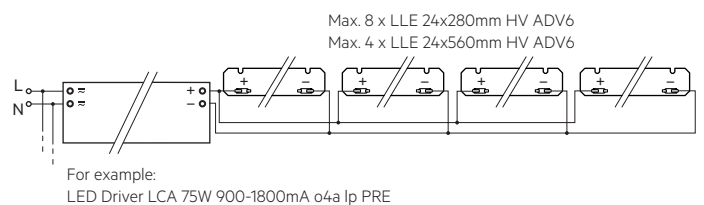

3.3 Wiring type and cross section

For wiring use stranded wire with ferrules or solid wire from 0.2 to 0.75 mm². For the push-wire connection you have to strip the insulation (8–9 mm).

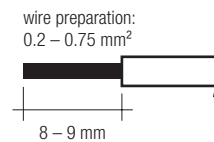

To remove the wires use a suitable tool (e.g. Microcon release pin) or through twist and pull.

3.4 Mounting instruction



None of the components of the LLE (substrate, LED, electronic components etc.) may be exposed to tensile or compressive stresses.

Max. torque for fixing: 0.5 Nm.

The LED modules are mounted onto a heat sink with min. 3 screws per module or ACL CLIP 4.3mm.

The LLE 24x70mm module is delivered as a board of 280mm (4 pcs.) and must be separated.

Only touch the module at the edge to separate the modules (see marking below).

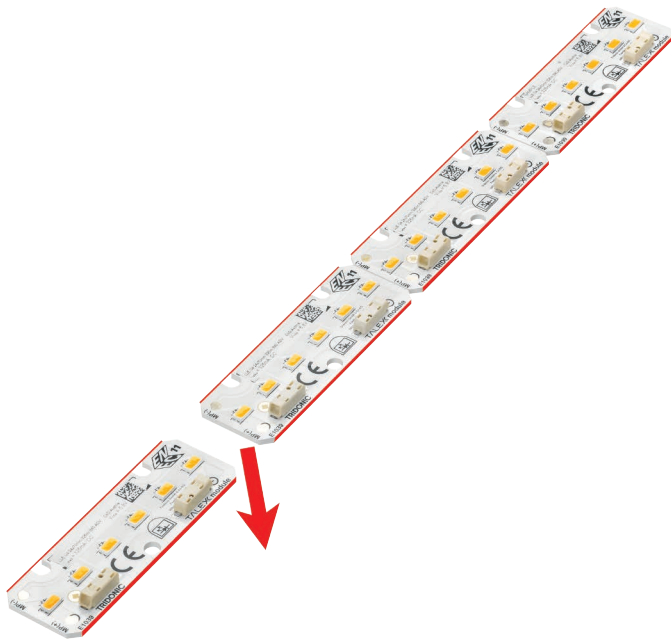

Cut out on gear tray for backside terminal:

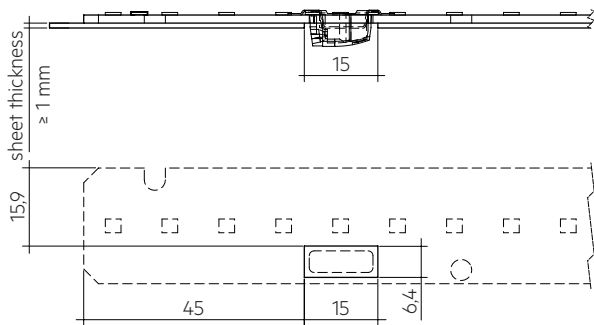

Chemical substance may harm the LED module. Chemical reactions could lead to colour shift, reduced luminous flux or a total failure of the module caused by corrosion of electrical connections.

Materials which are used in LED applications (e.g. sealings, adhesives) must not produce dissolver gas. They must not be condensation curing based, acetate curing based or contain sulfur, chlorine or phthalate.

Avoid corrosive atmosphere during usage and storage.

3.5 EOS/ESD safety guidelines



The device / module contains components that are sensitive to electrostatic discharge and may only be installed in the factory and on site if appropriate EOS/ESD protection measures have been taken. No special measures need be taken for devices/modules with enclosed casings (contact with the pc board not possible), just normal installation practice. Please note the requirements set out in the document EOS / ESD guidelines (Guideline_EOS_ESD.pdf) at: <http://www.tridonic.com/esd-protection>

4. Lifetime

4.1 Lifetime, lumen maintenance and failure rate

The light output of an LED module decreases over the lifetime, this is characterized with the L value.

L70 means that the LED module will give 70 % of its initial luminous flux.

This value is always related to the number of operation hours and therefore defines the lifetime of an LED module.

As the L value is a statistical value and the lumen maintenance may vary over the delivered LED modules.

The B value defines the amount of modules which are below the specific L value, e.g. L70B10 means 10 % of the LED modules are below 70 % of the initial luminous flux, respectively 90 % will be above 70 % of the initial value.

In addition the percentage of failed modules (fatal failure) is characterized by the C value.

4.2 Lumen maintenance for LLE 24mm HV ADV6

Forward current	tp tempera- ture	Lumen maintenance					
		L90 / B10	L90 / B50	L80 / B10	L80 / B50	L70 / B10	L70 / B50
100 mA	40 °C	>72k h	>72k h	>72k h	>72k h	>72k h	>72k h
	50 °C	>72k h	>72k h	>72k h	>72k h	>72k h	>72k h
	60 °C	>72k h	>72k h	>72k h	>72k h	>72k h	>72k h
	70 °C	>72k h	>72k h	>72k h	>72k h	>72k h	>72k h
	80 °C	>72k h	>72k h	>72k h	>72k h	>72k h	>72k h
	85 °C	>72k h	>72k h	>72k h	>72k h	>72k h	>72k h
275 mA	40 °C	61k h	>72k h	>72k h	>72k h	>72k h	>72k h
	50 °C	53k h	71k h	>72k h	>72k h	>72k h	>72k h
	60 °C	39k h	51k h	>72k h	>72k h	>72k h	>72k h
	70 °C	37k h	48k h	>72k h	>72k h	>72k h	>72k h
	80 °C	35k h	45k h	>72k h	>72k h	>72k h	>72k h
	85 °C	34kh	44k h	70k h	>72k h	>72k h	>72k h
700 mA	40 °C	48k h	62k h	>72k h	>72k h	>72k h	>72k h
	50 °C	45k h	59k h	>72k h	>72k h	>72k h	>72k h
	60 °C	42k h	55k h	>72k h	>72k h	>72k h	>72k h
	70 °C	40k h	52k h	>72k h	>72k h	>72k h	>72k h
	80 °C	37k h	49k h	>72k h	>72k h	>72k h	>72k h
	85 °C	36k h	47k h	>72k h	>72k h	>72k h	>72k h

L0C10 >72k h. At tp rated, based on 10 swichting cycles per day.

4.3 Switching capability

100,000 cycles

Tridonic test according to IEC 62717 Cl 10.3.3

30 s on / 30 s off at a forward current of 195 mA

5. Electrical values

5.1 Declaration of electrical parameters

I_{rated} ... Nominal operating current the module is designed for.

I_{max} ... Max. permissible continuous operating current incl. The tolerances of the LED driver.

Max. permissible LF current ripple ... Max. output current of the LED driver incl. Tolerances and LF current ripple must not exceed this value.

Max. permissible peak current ... The max. output peak current of the LED driver must not exceed this value.

5.2 Typ. forward voltage vs. forward current

LLE 24x70mm 325lm 9xx HV ADV6

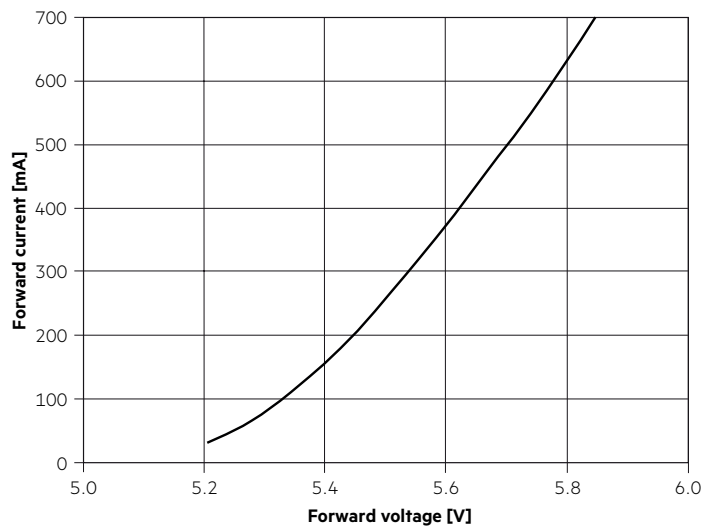

LLE 24x140mm 650lm 9xx HV ADV6

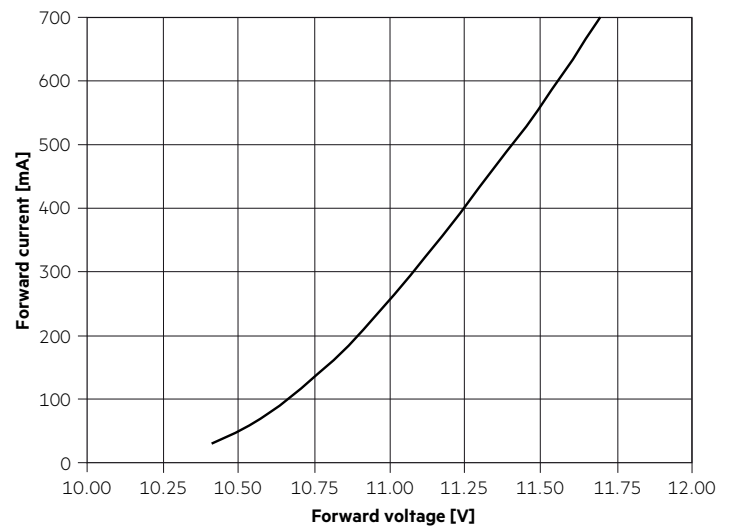

LLE 24x280mm 1250lm 9xx HV ADV6

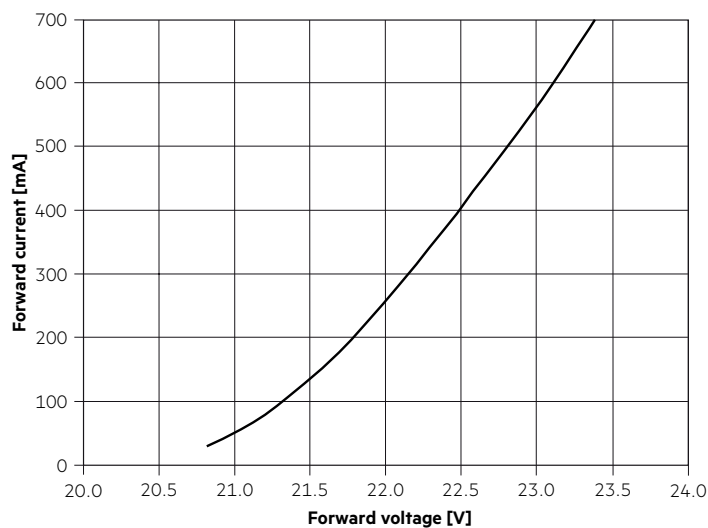

LLE 24x560mm 2400lm 9xx HV ADV6

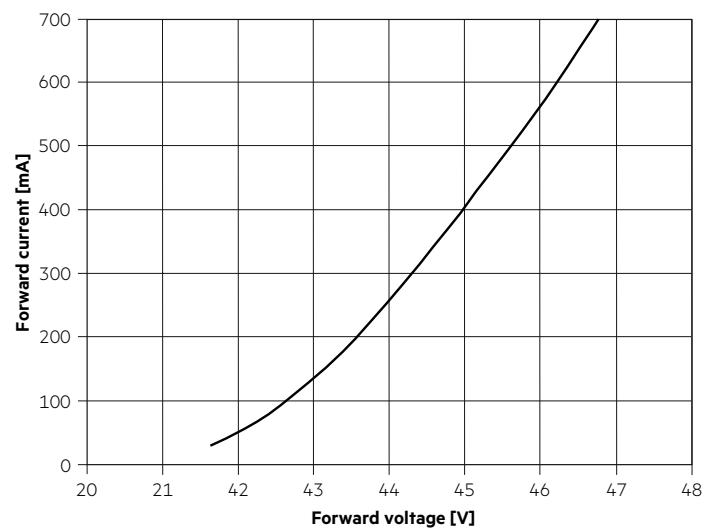

The diagrams are based on statistic values.
The real values can be different.

5.3 Forward voltage vs. tc temperature

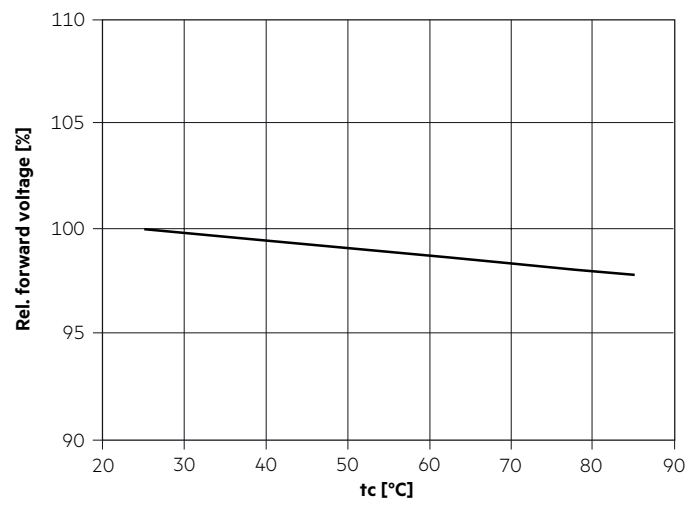

The diagrams are based on statistic values.
The real values can be different.

6. Photometric characteristics

6.1 Coordinates and tolerances according to CIE 1931

The specified colour coordinates are integral measured by current impulse of 195 mA and a duration of 100 ms.
 The ambient temperature of the measurement is $t_a = 25^\circ\text{C}$.
 The measurement tolerance of the colour coordinates are ± 0.01 .

2,700 K

	x0	y0
Centre	0.4578	0.4101

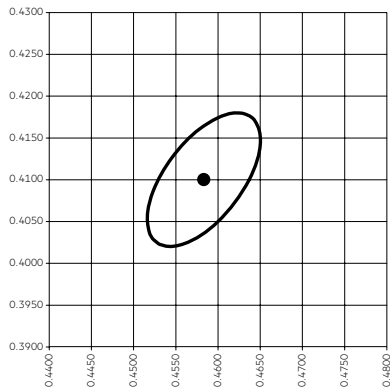

— MacAdam Ellipse: 3SDCM

TM30		CRI	
Rf	Rg	Ra	R9
91	99	93	57

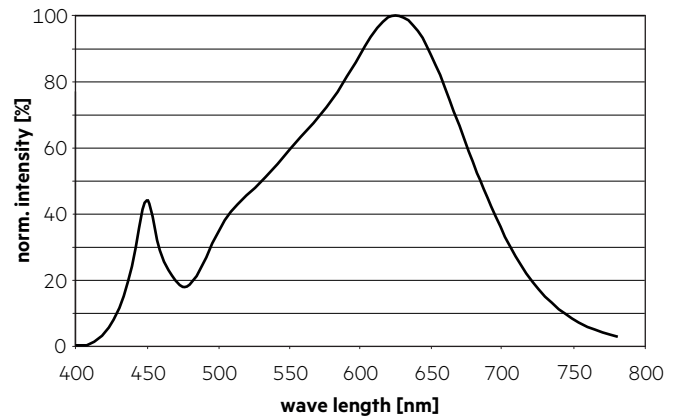

Colour vector graphic

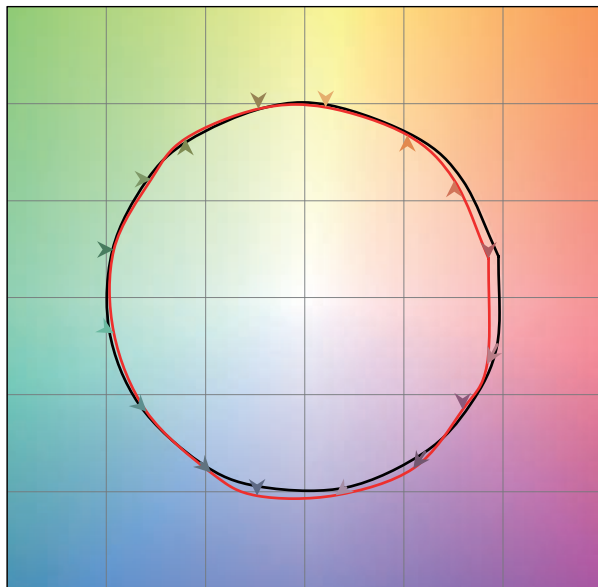

— Reference source
 — Test source

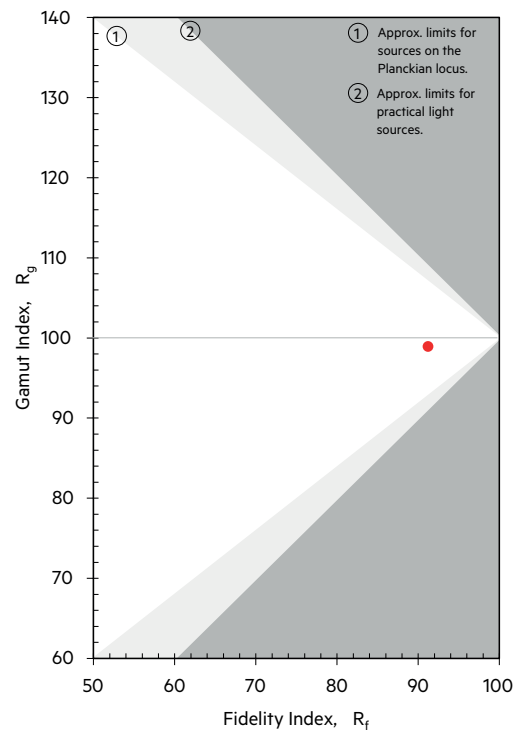

— MacAdam Ellipse: 3SDCM

3,000 K

	x0	y0
Centre	0.4338	0.4030

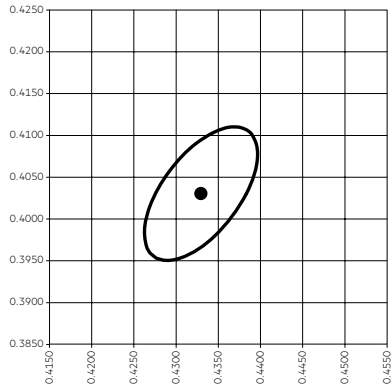

— MacAdam Ellipse: 3SDCM

TM30		CRI	
Rf	Rg	Ra	R9
90	98	92	57

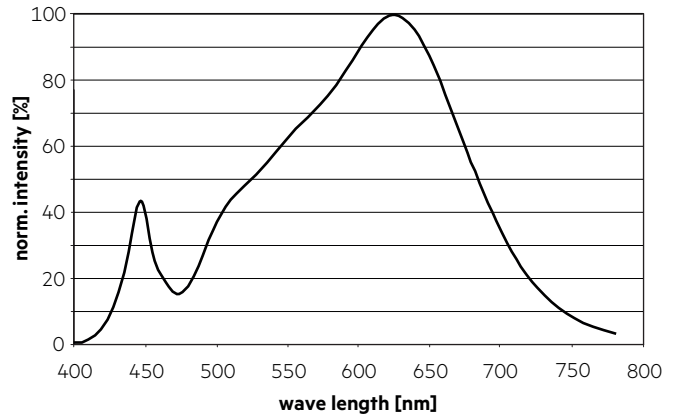

Colour vector graphic

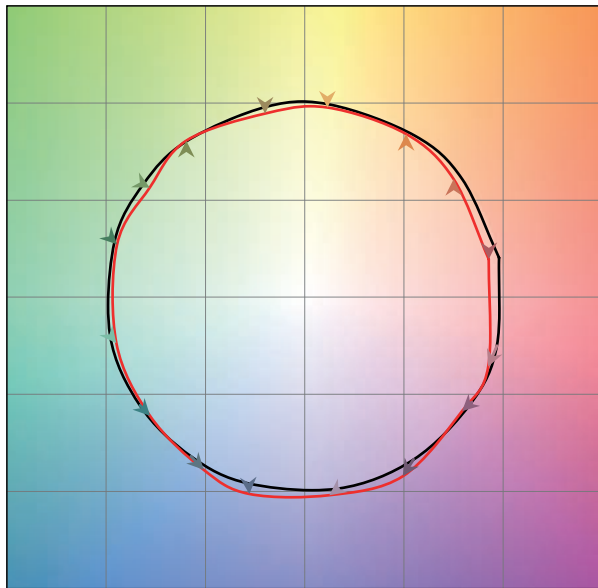

— Reference source
— Test source

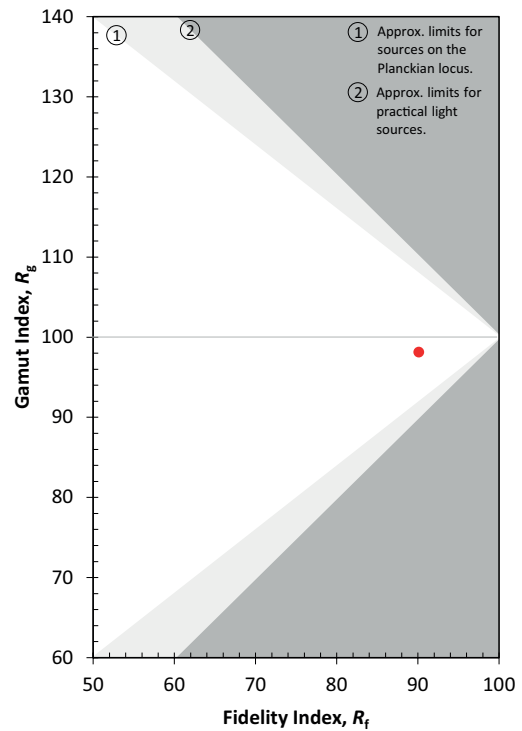

3,500 K

	x0	y0
Centre	0.4073	0.3917

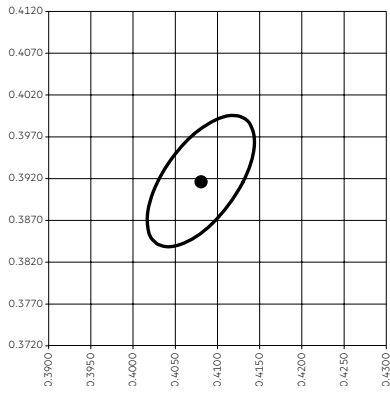

TM30		CRI	
Rf	Rg	Ra	R9
90	99	93	63

Colour vector graphic

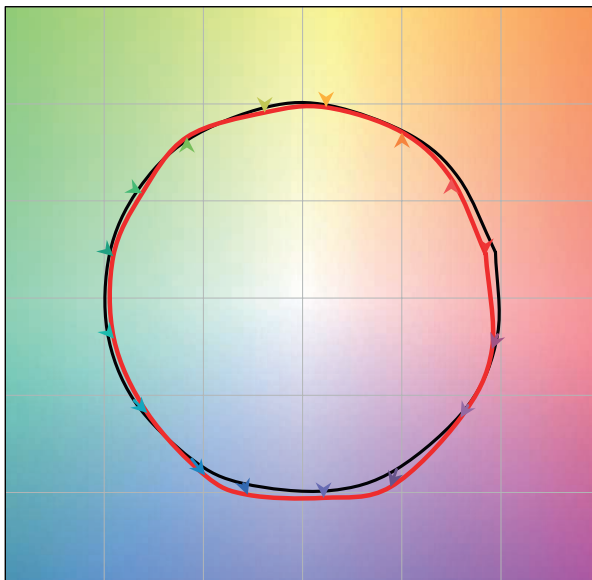

— Reference source
— Test source

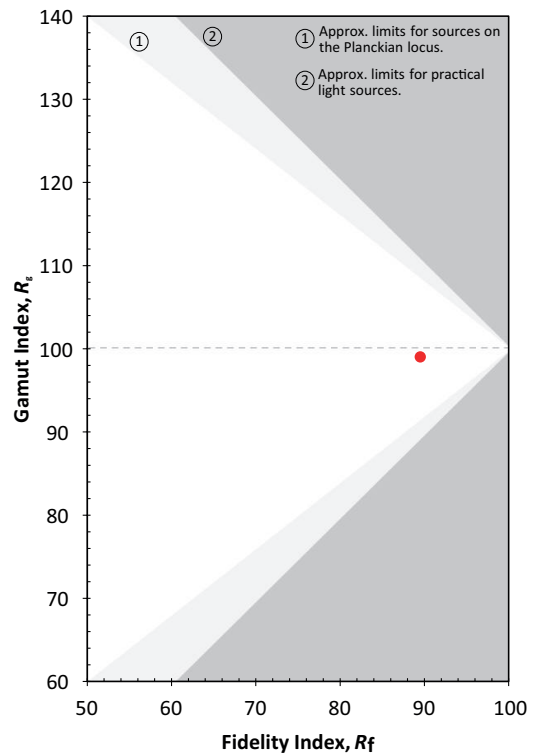
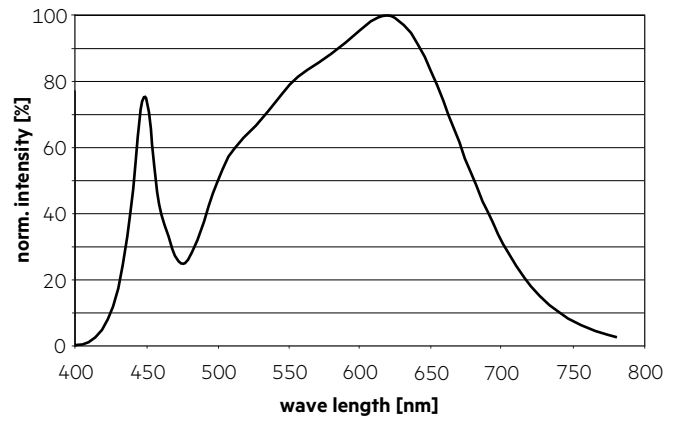

4,000 K

	x0	y0
Center	0.3818	0.3797

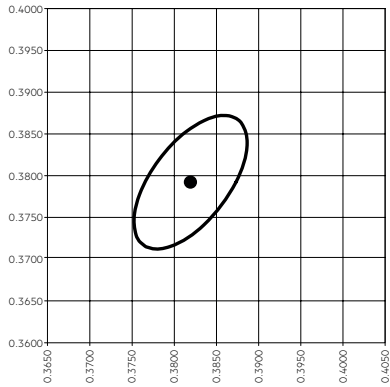

— MacAdam Ellipse: 3SDCM

TM30		CRI	
Rf	Rg	Ra	R9
89	99	91	54

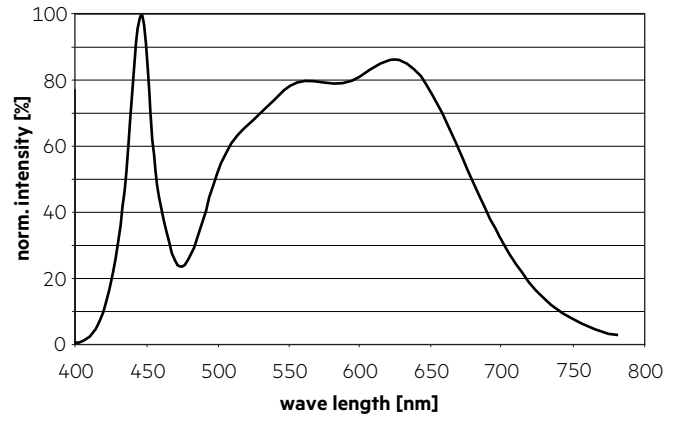

Colour vector graphic

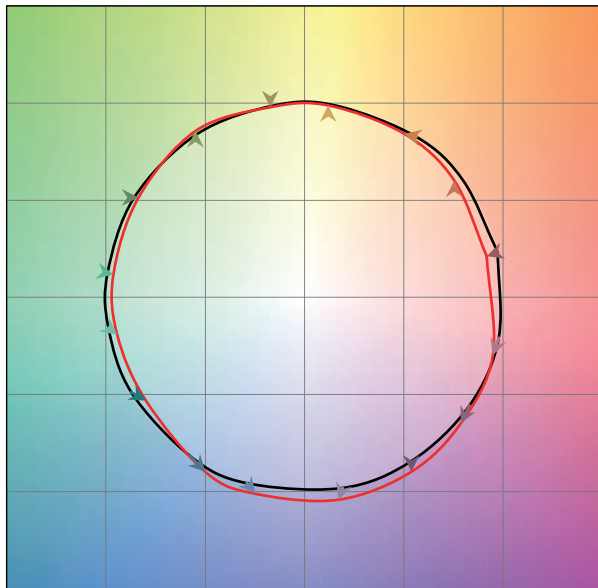

— Reference source
— Test source

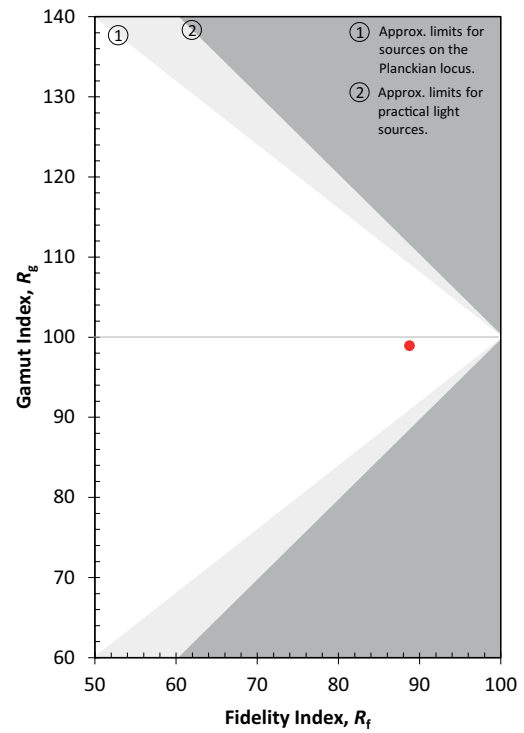

6.2 Light distribution

The optical design of the LLE product line ensures optimum homogeneity for the light distribution.

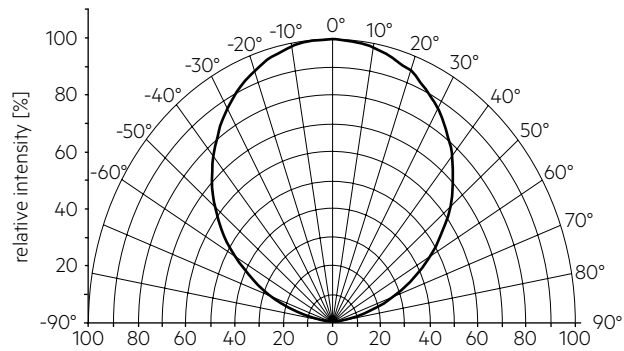

The colour temperature is measured integral over the complete module. The single LED light points can have deviations in the colour coordinates within MacAdam 5.

To ensure an ideal mixture of colours and a homogeneous light distribution a suitable optic (e. g. PMMA diffuser) and a sufficient spacing between module and optic (typ. 4 cm) should be used.

6.3 Relative luminous flux vs. tc temperature

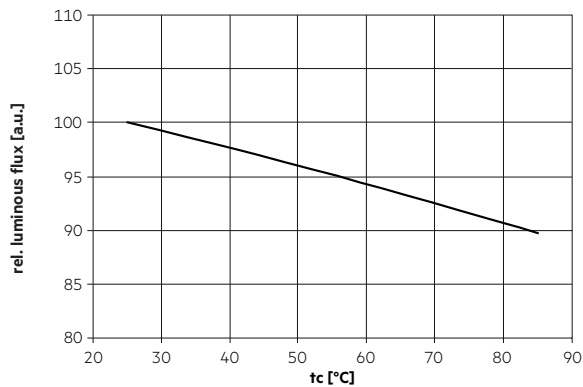

6.4 Relative luminous flux vs. operating current

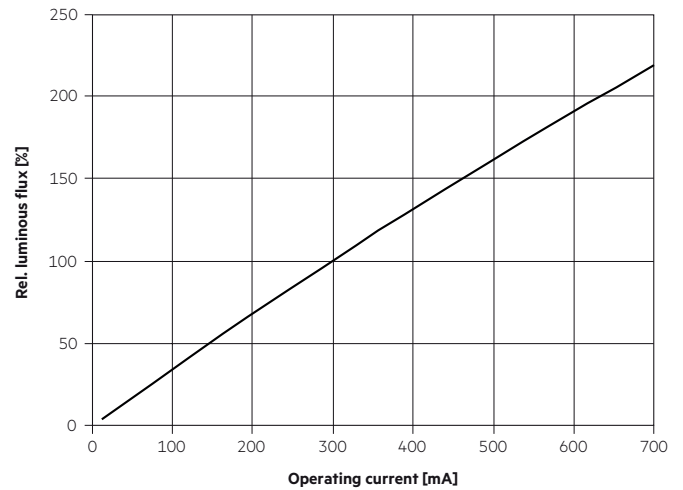

The diagrams are based on statistic values.
The real values can be different.

7. Miscellaneous

7.1 Additional information

Additional technical information at www.tridonic.com → Technical Data

Energy label and further information at www.tridonic.com in the certificates tab of the corresponding product page and at the EPREL data base <https://eprel.ec.europa.eu/>

Guarantee conditions at www.tridonic.com → Services

Lifetime declarations are informative and represent no warranty claim.