

**Driver LC 114W 1500-2100mA flexC C SNC4**

essence series

**Product description**

- \_ Fixed output built-in LED driver
- \_ For luminaires of protection class I and protection class II
- \_ Temperature protection as per EN 61347-2-13 C5e
- \_ Constant current LED driver
- \_ Selectable fixed output current 1,500, 1,750, 1,900 and 2,100 mA (pre-selected current 1,500 mA)
- \_ Max. output power 113.4 W
- \_ Nominal lifetime up to 100,000 h
- \_ 5 years guarantee (conditions at <https://www.tridonic.com/manufacture-guarantee-conditions>)

**Housing properties**

- \_ Casing: polycarbonate, white
- \_ Type of protection IP20

**Functions**

- \_ Overload protection
- \_ Short-circuit protection
- \_ No-load protection
- \_ Overtemperature protection

**Typical applications**

- \_ For spot light and downlight in retail and hospitality applications
- \_ For panel light and area light in office and education application

**Website**

<http://www.tridonic.com/87501127>

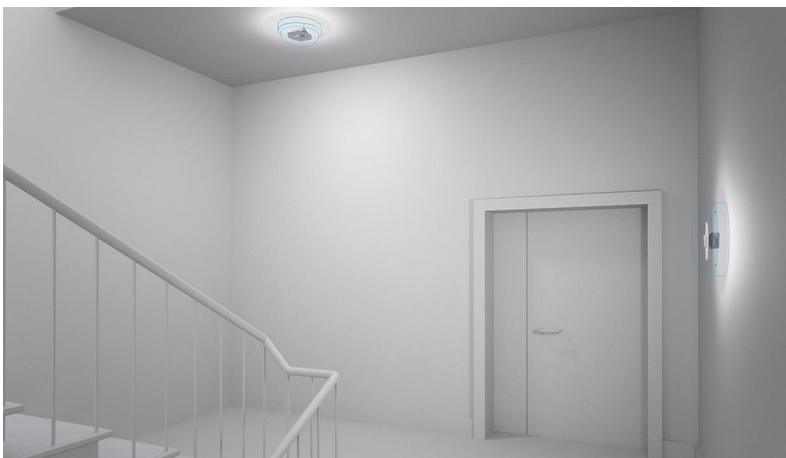

Spotlights



Downlights



Linear



Area



Floor | Wall



Free-standing



Street



Decorative



High bay



## Specific technical data

Type	Output current <sup>①</sup>	Min. output voltage	Max. output voltage	Max. output power	Typ. power consumption (at 230 V, 50 Hz, full load)	Typ. current consumption (at 230 V, 50 Hz, full load)	tc point max. <sup>③</sup>	Ambient temperature ta	I-out select
LC 114/1500-2100/57 flexC C SNC4	1,500 mA	27 V	57 V	85.5 W	95.5 W	420 mA	92 °C	-20 ... +50 °C	1=on / 2=on
LC 114/1500-2100/57 flexC C SNC4	1,750 mA	27 V	57 V	99.8 W	107.6 W	470 mA	94 °C	-20 ... +50 °C	1=off / 2=on
LC 114/1500-2100/57 flexC C SNC4	1,900 mA	27 V	57 V	108.3 W	114.5 W	500 mA	96 °C	-20 ... +50 °C	1=on / 2=off
LC 114/1500-2100/57 flexC C SNC4	2,100 mA	27 V	54 V	113.4 W	120.5 W	525 mA	96 °C	-20 ... +50 °C	1=off / 2=off

① Test result at 2,100 mA.

② Output current is mean value.

③ Test result at 25 °C.

④ Higher ambient temperatures are allowed as long as tc max. is not exceeded.

## 1. Standards

EN 55015  
 EN 61000-3-2  
 EN 61000-3-3  
 EN 61347-1  
 EN 61347-2-13  
 EN 61547  
 EN 62384

### 1.1 Glow-wire test

according to EN 61347-1 with increased temperature of 850 °C passed.

## 2. Thermal details and lifetime

### 2.1 Expected lifetime

Expected lifetime					
Type	Output current	ta	30 °C	40 °C	50 °C
LC 114/1500-2100/57 flexC C SNC4	1,500 mA	tc	72 °C	82 °C	92 °C
		Lifetime	>100,000 h	>100,000 h	>50,000 h
	1,750 mA	tc	74 °C	84 °C	94 °C
		Lifetime	>100,000 h	>100,000 h	>50,000 h
	1,900 mA	tc	76 °C	86 °C	96 °C
		Lifetime	>100,000 h	>100,000 h	>50,000 h
	2,100 mA	tc	76 °C	86 °C	96 °C
		Lifetime	>100,000 h	>100,000 h	>50,000 h

The LED drivers are designed for a lifetime stated above under reference conditions and with a failure probability of less than 10 %.

The relation of tc to ta temperature depends also on the luminaire design. If the measured tc temperature is approx. 5 K below tc max., ta temperature should be checked and eventually critical components (e.g. ELCAP) measured. Detailed information on request.

### 3. Installation / wiring

#### 3.1 Circuit diagram

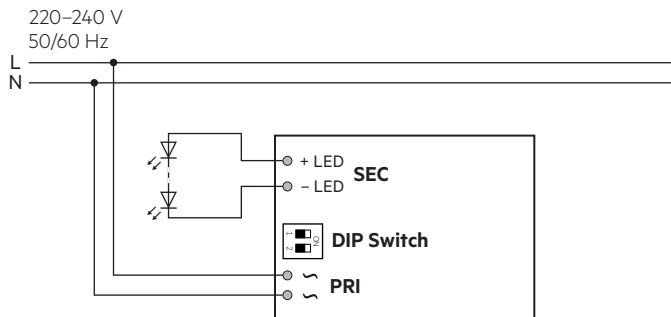

#### 3.2 Wiring type and cross section for input

For wiring use stranded wire with ferrules or solid wire from 0.5–1.5 mm<sup>2</sup>. Strip 8.5–9.5 mm of insulation from the cables to ensure perfect operation of the push-wire terminals.

Use one wire for each terminal connector only.

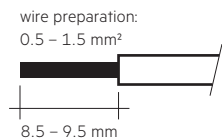

#### 3.3 Release of the wiring

Press down the "push button" and remove the cable from front.

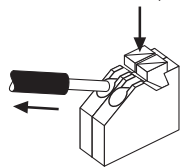

#### 3.4 Wiring type and cross section for output

For wiring use stranded wire with ferrules or solid wire from 0.2–1.5 mm<sup>2</sup>. Strip 8.5–9.5 mm of insulation from the cables to ensure perfect operation of the push-wire terminals.

Use one wire for each terminal connector only.

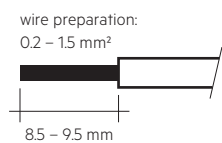

#### 3.6 Wiring guidelines

- All connections must be kept as short as possible to ensure good EMI behaviour.
- Mains leads should be kept apart from LED driver and other leads (ideally 5 – 10 cm distance)
- Max. length of output wires is 2 m.
- To comply with the EMC regulations run the secondary wires (LED module) in parallel.
- Secondary switching is not permitted.
- Incorrect wiring can damage LED modules.
- To avoid the damage of the Driver, the wiring must be protected against short circuits to earth (sharp edged metal parts, metal cable clips, louver, etc.).

#### 3.7 Replace LED module

1. Mains off
2. Remove LED module
3. Wait for 30 seconds
4. Connect LED module again

Hot plug-in or secondary switching of LEDs is not permitted and may cause a very high current to the LEDs.

#### 3.8 Installation instructions

The LED module and all contact points within the wiring must be sufficiently insulated against 3 kV surge voltage.

Air and creepage distance must be maintained.

#### 3.9 Current setting



Set the current by DIP switch after mains off.  
Use of DIP switch only after mains off.

**1,500 mA:** Switch 1 = On, Switch 2 = On

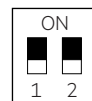

**1,750 mA:** Switch 1 = Off, Switch 2 = On



**1,900 mA:** Switch 1 = On, Switch 2 = Off

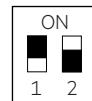

**2,100 mA:** Switch 1 = Off, Switch 2 = Off

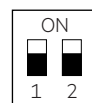

#### 3.10 Mounting of device

Max. torque for fixing: 0.5 Nm/M4

#### 4. Electrical values

##### 4.1 Efficiency vs load

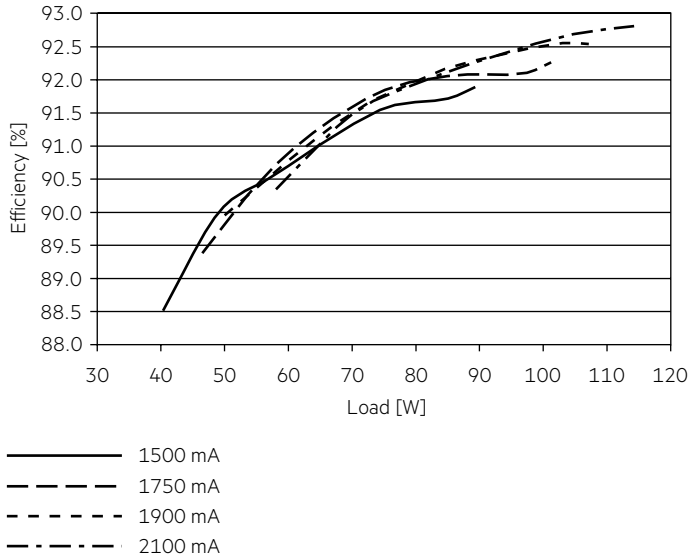

##### 4.3 THD vs load

THD without harmonic < 5 mA (0.6 %) of the input current:

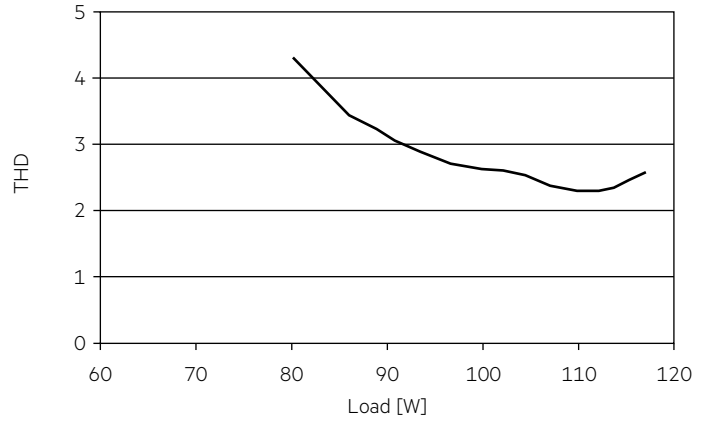

##### 4.2 Power factor vs load

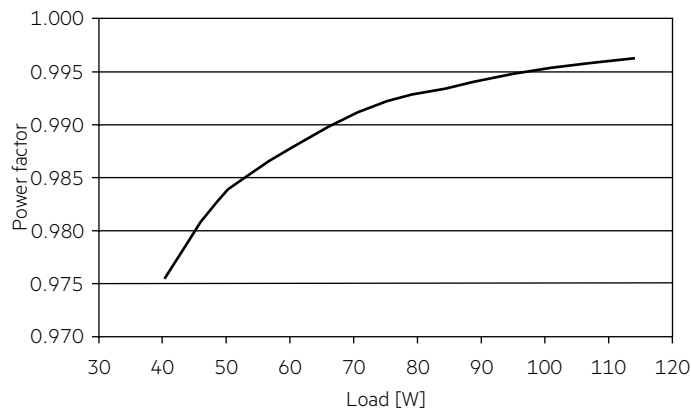

##### 4.6 Maximum loading of automatic circuit breakers in relation to inrush current

Automatic circuit breaker type	C10	C13	C16	C20	B10	B13	B16	B20	Inrush current
Installation Ø	1.5 mm <sup>2</sup>	1.5 mm <sup>2</sup>	1.5 mm <sup>2</sup>	2.5 mm <sup>2</sup>	1.5 mm <sup>2</sup>	1.5 mm <sup>2</sup>	1.5 mm <sup>2</sup>	2.5 mm <sup>2</sup>	I <sub>max</sub> Time
<b>LC 114/1500-2100/57 flexC C SNC4</b>	8	11	15	18	5	7	9	11	63 A 197 µs

These are max. values calculated out of inrush current! Please consider not to exceed the maximum rated continuous current of the circuit breaker. Calculation uses typical values from ABB series S200 as a reference. Actual values may differ due to used circuit breaker types and installation environment.

##### 4.7 Harmonic distortion in the mains supply (at 230 V / 50 Hz and full load) in %

	THD	3.	5.	7.	9.	11.
<b>LC 114/1500-2100/57 flexC C SNC4</b>	< 10	< 5	< 2	< 2	< 2	< 2

Acc. to 61000-3-2. Harmonics < 5 mA or < 0.6 % (whatever is greater) of the input current are not considered for calculation of THD.

## 5. Functions

### 5.1 Short-circuit behaviour

In case of a short circuit on the secondary side (LED) the the output power will reduce to very low.

After elimination of the short-circuit fault the LED driver will recover automatically.

### 5.2 No-load operation

The LED driver works in burst working mode to provide a constant output voltage regulation which allows the application to be able to work safely when LED string opens due to a failure.

### 5.3 Overload protection

If the maximum load is exceeded by a defined internal limit, the LED driver will protect itself and LED may flicker. After elimination of the overload the nominal operation will recover automatically.

### 5.4 Overtemperature protection

The LED driver is protected against temporary thermal overheating. If the temperature limit is exceeded, the output current will reduce or LED may flicker. It will recover automatically.

## 6. Miscellaneous

### 6.1 Disposal of equipment



Return old devices in accordance with the WEEE directive to suitable recycling facilities.

### 6.2 Insulation and electric strength testing of luminaires

Electronic devices can be damaged by high voltage. This has to be considered during the routine testing of the luminaires in production.

According to IEC 60598-1 Annex Q (informative only!) or ENEC 303-Annex A, each luminaire should be submitted to an insulation test with 500 V<sub>DC</sub> for 1 second. This test voltage should be connected between the interconnected phase and neutral terminals and the earth terminal. The insulation resistance must be at least 2 MΩ.

As an alternative, IEC 60598-1 Annex Q describes a test of the electrical strength with 1500 V<sub>AC</sub> (or 1.414 x 1500 V<sub>DC</sub>). To avoid damage to the electronic devices this test must not be conducted.

### 6.3 Conditions of use and storage

Humidity: 5% up to max. 85%,  
not condensed  
(max. 56 days/year at 85%)

Storage temperature: -40 °C up to max. +80 °C

The devices have to be within the specified temperature range (t<sub>a</sub>) before they can be operated.

### 6.4 Maximum number of switching cycles

All LED driver are tested with 50,000 switching cycles.

### 6.5 Additional information

Additional technical information at [www.tridonic.com](http://www.tridonic.com) → Technical Data

Lifetime declarations are informative and represent no warranty claim. No warranty if device was opened.