

**Driver LC 62W 700-1400mA flexC SC SNC4**

essence series

**Product description**

- \_ Fixed output LED driver
- \_ Can be either used built-in or independent with clip-on strain-relief
- \_ Independent LED driver with cable clamps
- \_ For luminaires of protection class I and protection class II
- \_ Temperature protection as per EN 61347-2-13 C5e
- \_ Constant current LED driver
- \_ Selectable fixed output current 700, 800, 900, 1,050, 1,100, 1,200, 1,300 and 1,400 mA (pre-selected current 700 mA)
- \_ Max. output power 61.6 W
- \_ Nominal lifetime up to 100,000 h
- \_ 5 years guarantee (conditions at <https://www.tridonic.com/manufacturer-guarantee-conditions>)

**Housing properties**

- \_ Casing: polycarbonate, white
- \_ Type of protection IP20

**Functions**

- \_ Overload protection
- \_ Short-circuit protection
- \_ No-load protection
- \_ Overtemperature protection

**Typical applications**

- \_ For spot light and downlight in retail and hospitality applications
- \_ For panel light and area light in office and education application

**Website**

<http://www.tridonic.com/87501125>

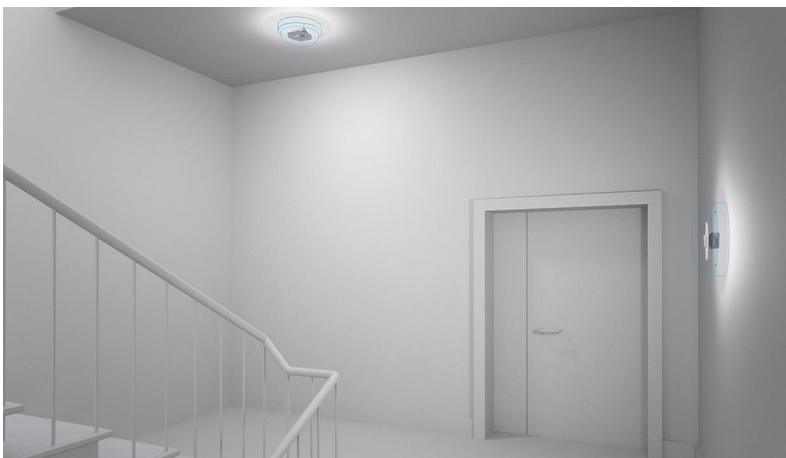

Spotlights



Downlights



Linear



Area



Floor | Wall



Free-standing



Street



Decorative



High bay

## Driver LC 62W 700-1400mA flexC SC SNC4

essence series

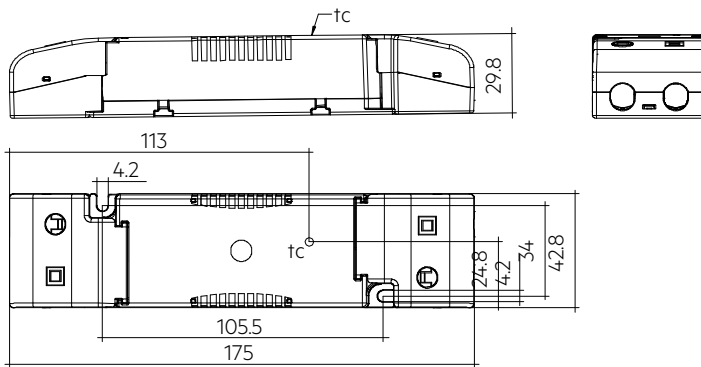
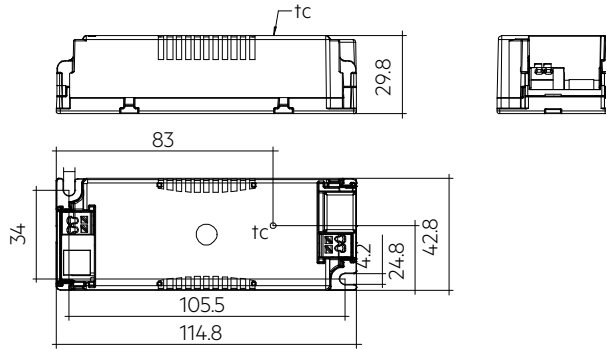

## Ordering data

Type	Article number	Packaging, carton	Packaging, pallet	Packaging, high volume	Weight per pc.
LC 62/700-1400/57 flexC SC SNC4	87501125	40 pc(s).	640 pc(s).	3,200 pc(s).	0.127 kg

**Technical data**

Rated supply voltage	220 – 240 V
AC voltage range	198 – 264 V
Max. input current (at 230 V, 50 Hz, full load)	0.295 A
Mains frequency	50 / 60 Hz
Overvoltage protection	320 V AC, 48 h
Typ. power consumption (at 230 V, 50 Hz, full load) <sup>①</sup>	66.5 W
Min. output power	18.9 W
Max. output power	61.6 W
Typ. efficiency (at 230 V, 50 Hz, full load) <sup>①</sup>	91 %
$\lambda$ over full operating range (max.) <sup>①</sup>	0.97
$\lambda$ over full operating range (min.)	0.86C
Output current tolerance <sup>②</sup>	± 7.5 %
Max. output peak current <sup>③</sup>	1,580 mA
Max. output voltage (U-OUT)	70 V
THD (at 230 V, 50 Hz, full load) <sup>①</sup>	< 10 %
Output LF current ripple (< 120 Hz)	± 5 %
Output P_ST_LM (at full load)	≤ 1
Output SVM (at full load)	≤ 0.4
Starting time (at 230 V, 50 Hz, full load)	≤ 0.5 s
Turn off time (at 230 V, 50 Hz, full load)	≤ 0.5 s
Hold on time at power failure (output)	0 s
Ambient temperature $t_a$ (at lifetime 50,000 h)	50 °C
Storage temperature $t_s$	-40 ... +80 °C
Mains burst capability	1 kV
Mains surge capability (between L - N)	1 kV
Mains surge capability (between L/N - PE)	2 kV
Surge voltage at output side (against PE)	3 kV
Lifetime	up to 100,000 h
Guarantee (conditions at <a href="http://www.tridonic.com">www.tridonic.com</a> )	5 Year(s)
Dimensions L x W x H	115 x 43 x 30 mm

**Approval marks****Standards**

EN 55015, EN 61000-3-2, EN 61000-3-3, EN 61347-1, EN 61347-2-13, EN 61547, EN 62384

**Specific technical data**

Type	Output current <sup>②</sup>	Min. output voltage	Max. output voltage	Max. output power	Typ. power consumption n (at 230 V, 50 Hz, full load)	Typ. current consumption n (at 230 V, 50 Hz, full load)	$t_c$ point max. <sup>⑤</sup>	Ambient temperature $t_a$	I-out select
LC 62/700-1400/57 flexC SC SNC4	700 mA	27 V	57 V	39.9 W	43.5 W	196 mA	71 °C	-20 ... +50 °C	1=off / 2=off / 3=off
LC 62/700-1400/57 flexC SC SNC4	800 mA	27 V	57 V	45.6 W	51.2 W	230 mA	72 °C	-20 ... +50 °C	1=on / 2=off / 3=off
LC 62/700-1400/57 flexC SC SNC4	900 mA	27 V	57 V	51.3 W	56.5 W	255 mA	74 °C	-20 ... +50 °C	1=off / 2=on / 3=off
LC 62/700-1400/57 flexC SC SNC4	1,050 mA	27 V	57 V	59.9 W	64.7 W	288 mA	76 °C	-20 ... +50 °C	1=on / 2=on / 3=off
LC 62/700-1400/57 flexC SC SNC4	1,100 mA	27 V	54 V	59.4 W	64.4 W	285 mA	76 °C	-20 ... +50 °C	1=off / 2=off / 3=on
LC 62/700-1400/57 flexC SC SNC4	1,200 mA	27 V	50 V	60.0 W	65.1 W	290 mA	77 °C	-20 ... +50 °C	1=on / 2=off / 3=on
LC 62/700-1400/57 flexC SC SNC4	1,300 mA	27 V	46 V	59.8 W	64.5 W	286 mA	77 °C	-20 ... +50 °C	1=off / 2=on / 3=on
LC 62/700-1400/57 flexC SC SNC4	1,400 mA	27 V	44 V	61.6 W	66.5 W	295 mA	78 °C	-20 ... +50 °C	1=on / 2=on / 3=on

<sup>①</sup> Test result at 1,400 mA.

<sup>②</sup> Output current is mean value.

<sup>③</sup> Test result at 25 °C.

<sup>④</sup> Values for built-in application. For independent application  $t_a$  max + 40 °C,  $t_c$  values see data sheet 2.1 Expected life-time.

<sup>⑤</sup> Higher ambient temperatures are allowed as long as  $t_c$  max. is not exceeded.

## Strain-relief set 43x30mm

Accessory



## Product description

- \_ Optional strain-relief set for independent applications
- \_ Transforms the LED driver into a fully class II compatible LED driver (e.g. ceiling installation)
- \_ Easy and tool-free mounting to the LED driver, screwless cable-clamp channels for long strain-relief (30 x 43 x 30 mm)
- \_ With screws for short strain-relief (15 x 34 x 30 mm)
- \_ Overall length = length L (LED driver) + 2 x 30 mm (long strain-relief set), 2 x 15 mm (short strain-relief) or long and short strain-relief any combination
- \_ Standard SC (L = 30 mm) available as non-pre-assembled and pre-assembled
- \_ Short SC (L = 15 mm) only pre-assembled available

## Website

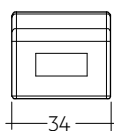
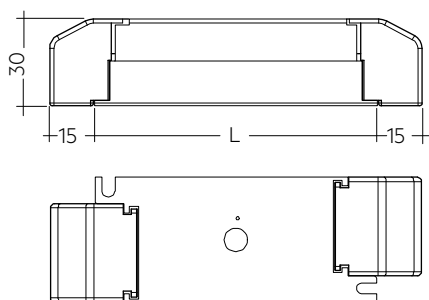
<http://www.tridonic.com/28001168>

Permissible  
cable jacket  
diameter:  
3 – 9 mm

## Ordering data

Type	Article number	Packaging, carton <sup>①</sup>	Packaging, outer box	Weight per pc.
ACU SC 43x30mm CLIP-ON SR SET	28001168	10 pc(s).	500 pc(s).	0.038 kg
ACU SC 43x30mm CLIP-ON SR SET 300	28001351	300 pc(s).	300 pc(s).	0.038 kg
ACU SC 30x43x30mm CLIP-ON SR PA	28001699	10 pc(s).	500 pc(s).	0.021 kg
ACU SC 15x43x30mm CLIP-ON SR PA	28001574	10 pc(s).	1,200 pc(s).	0.010 kg

## Approval marks



<sup>①</sup> 28001168: A carton of 10 pcs. is equal to 10 sets, each with 2 strain-reliefs parts. 28001351: A carton of 300 pcs. is equal to 300 sets, each with 2 strain-reliefs parts. 28001699 + 28001574: A carton contains exactly 10 pcs. strain-reliefs (no sets).

## 1. Standards

EN 55015  
 EN 61000-3-2  
 EN 61000-3-3  
 EN 61347-1  
 EN 61347-2-13  
 EN 61547  
 EN 62384

### 1.1 Glow-wire test

according to EN 61347-1 with increased temperature of 850 °C passed.

## 2. Thermal details and lifetime

### 2.1 Expected lifetime

#### Expected lifetime for built-in use

Type	Output current	ta	30 °C	40 °C	50 °C
LC 62/700-1400/57 flexC SC SNC4	700 mA	tc	51 °C	61 °C	71 °C
		Lifetime	>100,000 h	>100,000 h	>50,000 h
	800 mA	tc	52 °C	62 °C	72 °C
		Lifetime	>100,000 h	>100,000 h	>50,000 h
	900 mA	tc	54 °C	64 °C	74 °C
		Lifetime	>100,000 h	>100,000 h	>50,000 h
	1,050 / 1,100 mA	tc	56 °C	66 °C	76 °C
		Lifetime	>100,000 h	>100,000 h	>50,000 h
	1,200 / 1,300 mA	tc	57 °C	67 °C	77 °C
		Lifetime	>100,000 h	>100,000 h	>50,000 h
	1,400 mA	tc	58 °C	68 °C	78 °C
		Lifetime	>100,000 h	>100,000 h	50,000 h

#### Expected lifetime for independent use

Type	Output current	ta	25 °C	30 °C	40 °C
LC 62/700-1400/57 flexC SC SNC4	700 mA	tc	51 °C	56 °C	66 °C
		Lifetime	>100,000 h	>100,000 h	>50,000 h
	800 mA	tc	53 °C	58 °C	68 °C
		Lifetime	>100,000 h	>100,000 h	>50,000 h
	900 mA	tc	55 °C	60 °C	70 °C
		Lifetime	>100,000 h	>100,000 h	>50,000 h
	1,050 / 1,100 mA	tc	58 °C	63 °C	73 °C
		Lifetime	>100,000 h	>100,000 h	>50,000 h
	1,200 / 1,300 mA	tc	59 °C	64 °C	74 °C
		Lifetime	>100,000 h	>100,000 h	>50,000 h
	1,400 mA	tc	60 °C	65 °C	75 °C
		Lifetime	>100,000 h	>100,000 h	50,000 h

The LED drivers are designed for a lifetime stated above under reference conditions and with a failure probability of less than 10 %.

The relation of tc to ta temperature depends also on the luminaire design. If the measured tc temperature is approx. 5 K below tc max., ta temperature should be checked and eventually critical components (e.g. ELCAP) measured. Detailed information on request.

### 3. Installation / wiring

#### 3.1 Circuit diagram

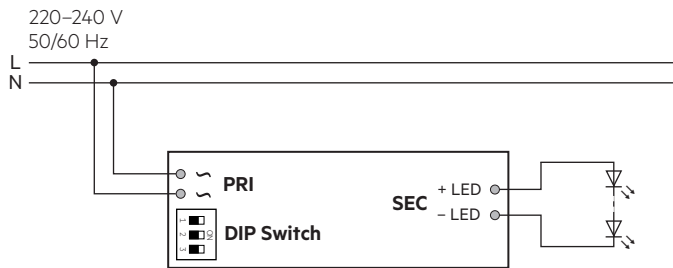

#### 3.2 Wiring type and cross section for input

For wiring use stranded wire with ferrules or solid wire from 0.5–1.5 mm<sup>2</sup>. Strip 8.5–9.5 mm of insulation from the cables to ensure perfect operation of the push-wire terminals. Use one wire for each terminal connector only.

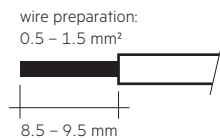

#### 3.3 Release of the wiring

Press down the “push button” and remove the cable from front.

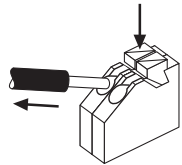

#### 3.4 Fixing conditions when using as independent Driver with Clip-On

Dry, acidfree, oilfree, fatfree. It is not allowed to exceed the maximum ambient temperature ( $t_a$ ) stated on the device. Minimum distances stated below are recommendations and depend on the actual luminaire. Is not suitable for fixing in corner.

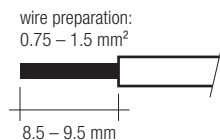
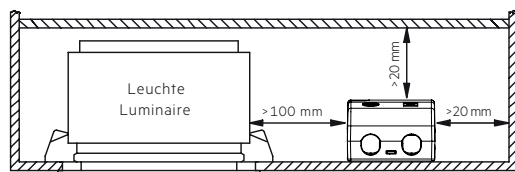

#### 3.5 Wiring type and cross section for output

For wiring use stranded wire with ferrules or solid wire from 0.2–1.5 mm<sup>2</sup>. Strip 8.5–9.5 mm of insulation from the cables to ensure perfect operation of the push-wire terminals. Use one wire for each terminal connector only.

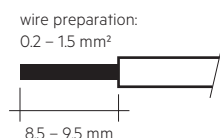

#### 3.6 Wiring guidelines

- All connections must be kept as short as possible to ensure good EMI behaviour.
- Mains leads should be kept apart from LED driver and other leads (ideally 5 – 10 cm distance)
- Max. length of output wires is 2 m.
- To comply with the EMC regulations run the secondary wires (LED module) in parallel.
- Secondary switching is not permitted.
- Incorrect wiring can damage LED modules.
- To avoid the damage of the Driver, the wiring must be protected against short circuits to earth (sharp edged metal parts, metal cable clips, louver, etc.).

#### 3.7 Replace LED module

1. Mains off
2. Remove LED module
3. Wait for 30 seconds
4. Connect LED module again

Hot plug-in or secondary switching of LEDs is not permitted and may cause a very high current to the LEDs.

#### 3.8 Installation instructions

The LED module and all contact points within the wiring must be sufficiently insulated against 3 kV surge voltage.

Air and creepage distance must be maintained.

### 3.9 Current setting



Set the current by DIP switch after mains off.  
Use of DIP switch only after mains off.

**700 mA:** Switch 1 = Off, Switch 2 = Off, Switch 3 = Off

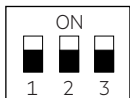

**800 mA:** Switch 1 = On, Switch 2 = Off, Switch 3 = Off

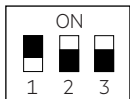

**900 mA:** Switch 1 = Off, Switch 2 = On, Switch 3 = Off

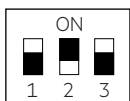

**1,050 mA:** Switch 1 = On, Switch 2 = On, Switch 3 = Off

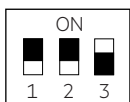

**1,100 mA:** Switch 1 = Off, Switch 2 = Off, Switch 3 = On

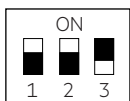

**1,200 mA:** Switch 1 = On, Switch 2 = Off, Switch 3 = On

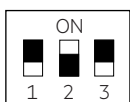

**1,300 mA:** Switch 1 = Off, Switch 2 = On, Switch 3 = On

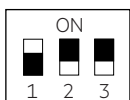

**1,400 mA:** Switch 1 = On, Switch 2 = On, Switch 3 = On

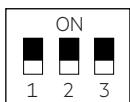

### 3.10 Mounting of device

Max. torque for fixing: 0.5 Nm/M4

## 4. Electrical values

### 4.1 Efficiency vs load

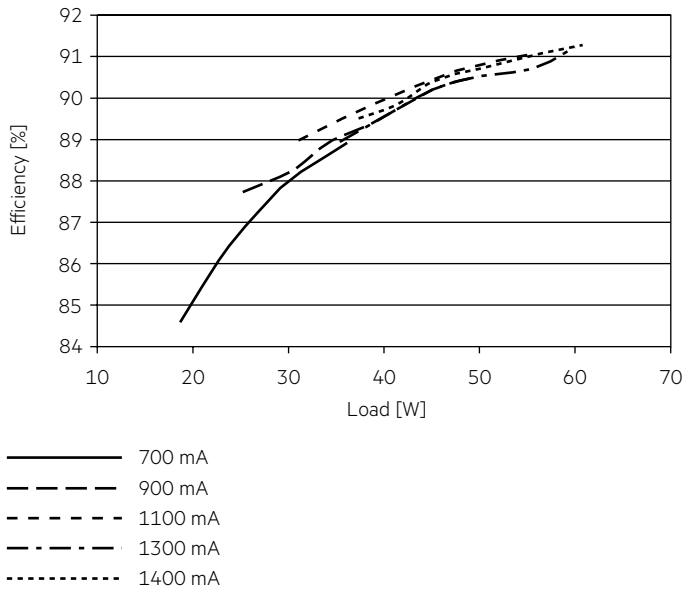

### 4.3 THD vs load

THD without harmonic < 5 mA (0.6 %) of the input current:

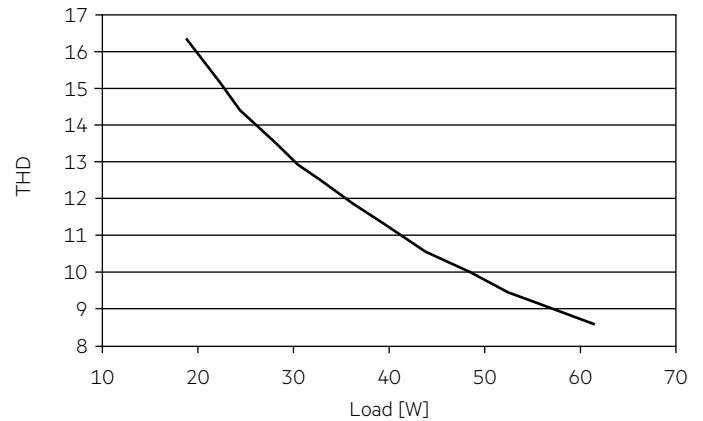

### 4.2 Power factor vs load

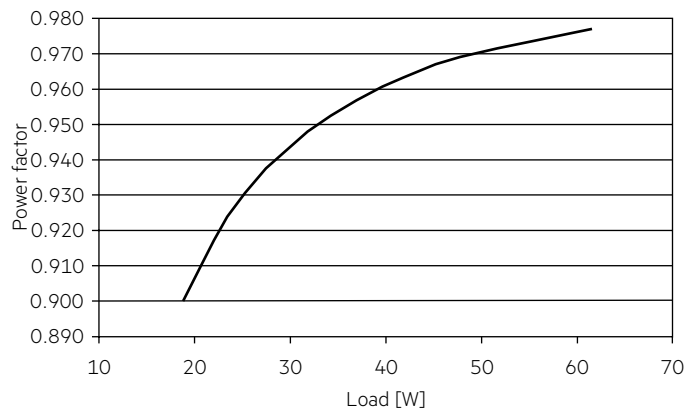

### 4.6 Maximum loading of automatic circuit breakers in relation to inrush current

Automatic circuit breaker type	C10	C13	C16	C20	B10	B13	B16	B20	Inrush current
Installation Ø	1.5 mm <sup>2</sup>	1.5 mm <sup>2</sup>	1.5 mm <sup>2</sup>	2.5 mm <sup>2</sup>	1.5 mm <sup>2</sup>	1.5 mm <sup>2</sup>	1.5 mm <sup>2</sup>	2.5 mm <sup>2</sup>	I <sub>max</sub> Time
<b>LC 62/700-1400/57 flexC SC SNC4</b>	16	21	26	35	10	13	16	21	55 A 130 µs

These are max. values calculated out of inrush current! Please consider not to exceed the maximum rated continuous current of the circuit breaker.

Calculation uses typical values from ABB series S200 as a reference.

Actual values may differ due to used circuit breaker types and installation environment.

### 4.7 Harmonic distortion in the mains supply (at 230 V / 50 Hz and full load) in %

	THD	3.	5.	7.	9.	11.
<b>LC 62/700-1400/57 flexC SC SNC4</b>	< 10	< 8	< 3	< 2	< 2	< 2

Acc. to 61000-3-2. Harmonics < 5 mA or < 0.6 % (whatever is greater) of the input current are not considered for calculation of THD.

## 5. Functions

### 5.1 Short-circuit behaviour

In case of a short circuit on the secondary side (LED) the LED driver switches off. After elimination of the short-circuit fault the LED driver will recover automatically.

### 5.2 No-load operation

The LED driver works in burst working mode to provide a constant output voltage regulation which allows the application to be able to work safely when LED string opens due to a failure.

### 5.3 Overload protection

If the maximum load is exceeded by a defined internal limit, the LED driver will protect itself and LED may flicker. After elimination of the overload the nominal operation will recover automatically.

### 5.4 Overtemperature protection

The LED driver is protected against temporary thermal overheating. If the temperature limit is exceeded, the output current will reduce or LED may flicker. It will recover automatically.

## 6. Miscellaneous

### 6.1 Disposal of equipment



Return old devices in accordance with the WEEE directive to suitable recycling facilities.

### 6.2 Insulation and electric strength testing of luminaires

Electronic devices can be damaged by high voltage. This has to be considered during the routine testing of the luminaires in production.

According to IEC 60598-1 Annex Q (informative only!) or ENEC 303-Annex A, each luminaire should be submitted to an insulation test with 500 V<sub>DC</sub> for 1 second. This test voltage should be connected between the interconnected phase and neutral terminals and the earth terminal. The insulation resistance must be at least 2 MΩ.

As an alternative, IEC 60598-1 Annex Q describes a test of the electrical strength with 1500 V<sub>AC</sub> (or 1.414 x 1500 V<sub>DC</sub>). To avoid damage to the electronic devices this test must not be conducted.

### 6.3 Conditions of use and storage

Humidity: 5% up to max. 85%,  
not condensed  
(max. 56 days/year at 85%)

Storage temperature: -40 °C up to max. +80 °C

The devices have to be within the specified temperature range (t<sub>a</sub>) before they can be operated.

### 6.4 Maximum number of switching cycles

All LED driver are tested with 50,000 switching cycles.

### 6.5 Additional information

Additional technical information at [www.tridonic.com](http://www.tridonic.com) → Technical Data

Lifetime declarations are informative and represent no warranty claim. No warranty if device was opened.